



NATIONAL

# RANGE AND TARGET ACTIVITIES

MANUAL

## Acknowledgments

Scouting America greatly appreciates the National Range and Target Activities Subcommittee members for their expertise and recommendations in the development of the *National Range and Target Activities Manual*.

We would also like to acknowledge the longstanding relationship with the National Rifle Association (NRA) in the goal of training youth and adults in the safe use of firearms.

Scouting America would like to acknowledge the relationship with USA Archery for the relationship in developing and training youth and adults in safe archery experiences.

## SCOUTING AMERICA'S COMMITMENT TO SAFETY

In Scouting, we will not compromise the safety of our youth, volunteers, and employees. Safety is a value that must be taught and reinforced at every opportunity. We are all responsible and must hold each other accountable to provide a safe environment for all participants.

We are committed to abuse prevention by utilizing:

- Mandatory youth protection training.
- Criminal background checks.
- Banning one-on-one adult and youth interactions.
- Mandatory reporting of suspected abuse to law enforcement.
- A volunteer screening database.

We are committed to injury and illness prevention by integrating safety measures in our handbooks, literature, and training materials including the *Guide to Safe Scouting*. We expect leaders to use the four points of **SAFE** when delivering the program. **SAFE** Scouting measures include:

- Youth are **Supervised** by qualified and trustworthy adults who set the example for safety.
- Activities are **Assessed** for risks.
- Pre-requisite **Fitness** and **skill** levels are confirmed before participation.
- Appropriate **Equipment** is utilized and **Environmental** conditions are monitored.

When incidents do occur, we expect a timely, clear, and complete incident report. We are committed to learning from the data and modifying program guidance for the prevention of future occurrence.



## INTRODUCTION

The purpose of Scouting America's range and target activities is first and foremost centered around teaching safety. Scouting America's range and target activities are developed and implemented through age-appropriate training and experiences. Scouting America adheres to its longstanding policy of teaching its youth and adult members the safe, responsible, and intelligent handling, care, and use of firearms, archery, and hand-held throwing sports in planned, carefully managed, and supervised programs for each youth who chooses to participate.

In addition, participating in range and target activities provides Scouts the opportunity to learn responsibility, self-discipline, problem solving, concentration, sportsmanship and acquire lifelong skills and hobby interest.

Scouting America follows the SAFE practices and requires all ranges to have Standard Operating Procedures (SOP) that are approved for that range. Range supervision and instruction are overseen by qualified staff with a key focus of Scout safety.

The Scouting America's National Range and Target Activities Subcommittee understands the need for clarification in the terminology and delivery of range and target activities. The Guide to Safe Scouting and this manual contains information for all the range and target activities and provides guidance for their implementation in Scouting. **No other range and target activities are authorized at this time.** Information on approved firearms, ranges, qualified supervision, training requirements, targets, and ammunition is included.



## Scouting is SAFE – Range and Target Activities

Scouting America adheres to its longstanding policy of teaching its youth and adult members the safe, responsible, and intelligent handling, care, and use of firearms, archery and hand-held throwing sports in planned, carefully managed, and supervised programs. Safety during range and target activities must remain top of mind.

### Supervision

Youth are supervised by qualified and trustworthy adults who set the example for safety. Supervision includes:

- Range Management - a range safety position(s) who oversee the shooting stations and participants. At a minimum, all Scouts BSA troops, Venturing crews, and Sea Scout ships who provide unit-level sponsored/planned range and target activities must have at least one registered unit leader 21+ years of age take the Range Activity SAFETY online training at my.Scouting. This individual must be present at the range during the activity.
- Instruction – participants with the right demeanor, skills, abilities and validated credentials to teach safety and develop the participant’s ability at that activity.
- During live fire, range safety positions and instructors may be supplemented by coaches, registered leaders, and even parents and partners to support a safe experience for participants.
- Cub Scout range and target activities are only conducted and supervised by local Councils. Cub Scout pack unit level sponsored range and target activities are prohibited.

### Assessment

Activities are assessed for risks during planning. Leaders have reviewed applicable program guidance or standards and have verified the activity is not prohibited. Risk avoidance or mitigation is incorporated into the activity.

Assessment includes:

- Validating the range and target activities are age-appropriate for the participants being served. Please review the Guide to Safe Scouting Age-Appropriate Guidelines Chart prior to beginning the activity.
- When utilizing council’s nationally authorized camp property’s range(s) or commercial ranges, standard operating procedures for each venue are available, fitting the discipline, equipment and ammunition being used.
- Verification of state and local laws regarding range and target activities are followed.

### Fitness and Skill

Participants’ Annual Health and Medical Records are reviewed, and leaders have confirmed that prerequisite fitness and skill levels exist for participants to take part safely. This includes:

- An instructor reviewing participant’s ability (with or without accommodations) to safely operate the device, firearm, or bow, or throwing object.
- Participants have received the appropriate on-site safety briefing before participation including the three rules of firearm safety.

### Equipment and Environment

Safe and appropriately sized equipment, courses, camps, campsites, trails, or playing fields are used correctly. Leaders periodically check gear use and the environment for changing conditions that could affect safety. This includes:

- Before any use, and periodically, all equipment (shooting devices, firearms, bows, slingshots, hawks, knives, target frames or targets, etc.) should be inspected by a range supervision and instruction and qualified gunsmiths or archery retailer.
- Safe and secure storage and transportation for firearms, ammunition, bows, etc.
- Personal Protective Equipment for all participants and observers is available and used as required. Including:
  - Eye protection
  - Hearing protection
  - Armguards
  - Finger Tabs or finger savers
  - Appropriate attire



# CONTENTS

<b>Section I</b>	<b>The Essentials</b>	
<b>Chapter 1:</b>	<b>Qualified Supervision—Roles and Responsibilities</b>	7
	Introduction to Range and Target Activities and the Positive Aspects	7
	Range and Target Activities Personnel Descriptions	7
	Definition of “Instructor Qualified”	8
	Five Levels of Shooting Activities	14
<b>Chapter 2:</b>	<b>Range and Target Activities—A Wealth of Year-Round Opportunities</b>	20
	Cub Scout Programs	20
	Scouts BSA Programs	20
	Venturing and Sea Scout Programs	20
<b>Chapter 3:</b>	<b>Merit Badge Counselors</b>	22
	Range and Target Activities Merit Badge Counselor Requirements and Registration	22
	Resources for Merit Badge Counselors	22
<b>Section II</b>	<b>Beyond the Unit Level</b>	
<b>Chapter 4:</b>	<b>Council Range and Target Activities Committee</b>	25
	Organization	25
	Responsibilities	25
	Directing Cub Scout Range and Target Activities in a Council Program	26
	Safety Instruction Guidelines	26
	Positive Aspects of Range and Target Activities	26
<b>Chapter 5:</b>	<b>Range Operation</b>	27
	General Equipment Common to All Scouting Program Levels and Shooting Disciplines	27
	Range and Shooting Equipment Appropriate to Each Scouting Program Level	28
<b>Section III</b>	<b>Health and Safety</b>	
<b>Chapter 6:</b>	<b>Safety</b>	35
	Communications	35
	Emergency Response Plans	35
	National Camping Standards	35
	Standard Operating Procedures	35
	Equipment Inspections—Firearms and Archery	35
<b>Chapter 7:</b>	<b>Additional Considerations</b>	35
	General	35
<b>Section IV</b>	<b>Training</b>	
<b>Chapter 8:</b>	<b>Training Courses</b>	39
	Scouting America Training	39
	National Rifle Association Training	39
	Archery Training	40
<b>Section V</b>	<b>Range and Target Activities for Cub Scouts</b>	
<b>Chapter 9:</b>	<b>Introduction</b>	45
	Leadership	45

## Section VI Other Range and Target Activities for All Program Levels

<b>Chapter 10: Other Range and Target Activities for All Program Levels</b> .....	67
Safe Ranges.....	67
Pellet Rifles.....	67
Slingshots and Wrist-Braced Slingshots.....	67
Catapults and Other Shooting Devices.....	69
Sporting Arrows and Flash Ball.....	69
Tomahawk and Knife Throwing.....	70
<b>Chapter 11: Resources, Certificates, and Patches</b> .....	75
Resources.....	75
Sample Archery Scorecard.....	77
Sample Targets.....	78
Crossword Puzzle: Air Gun.....	79
Quiver and Bow Rack.....	80
Archery Storage Locker.....	81
Glossary.....	85

## Appendices

1 NRA FIRST Steps Scouts BSA Shotgun Shooting Merit Badge Teaching Guide.....	91
2 NRA FIRST Steps Scouts BSA Rifle Shooting Merit Badge Teaching Guide.....	125
3 Sample Standard Operating Procedures Manual.....	157
4 Range and Target Activities Decision Tree.....	161
5 Cub Scout BB Gun Range and Target Activities.....	163
Training Archery Rangemasters.....	165
Training BB Gun Rangemasters.....	166
6 Prohibited Activities.....	167
7 Open Shooting Archery Experience.....	169
8 Instructional Archery Experience.....	173
9 Pistol Shooting.....	177
10 Multigun Airsoft Experience.....	180
11 Chalk Ball Program Guide.....	191
12 Cowboy Action Program Guide.....	197
13 Instructional Rifle Experience.....	204
14 Open Rifle Experience.....	208
15 Instructional Shotgun Experience.....	212
16 Open Shotgun Experience.....	216
17 Sporting Arrows.....	220
18 Cub Scout Range and Target Activities Adventure Lesson Plans.....	221
19 Resources.....	259



## **SECTION I**

# **THE ESSENTIALS**

The information in Section I is essential for everyone involved in Scouting America's range and target activities programs. This includes all individuals working with Cub Scouting, Scouts BSA, Venturing, Sea Scouting, or range and target activities committees.



# CHAPTER 1: QUALIFIED SUPERVISION—ROLES AND RESPONSIBILITIES

## Introduction to Range and Target Activities and the Positive Aspects

Throughout Scouting America from Cub Scouting to Venturing and Sea Scouting, all programs use responsible outdoor activities to promote character development and values-based leadership training. Range and target activities have the ability to attract and retain youth in the movement. Millions of young people participate in one or more of the sports annually—archery, rifle and shotgun activities, etc.—guided by adults who have the certification, skills and knowledge to provide quality programs in a safe and effective way.

Key to safe and effective unit activities is informed, trained, and conscientious unit leadership. Various activities can present some degree of risk; those risks can be mitigated by training and commitment of Scouting volunteer leaders. When activities are properly conducted under the appropriate guidelines, they can be safe, fun filled, exciting, and rewarding.

The registered adult leader(s) in charge are always responsible for ensuring that all activities adhere to the age appropriate guidelines and follow the program design of Scouting America. However, Scouting America policy does not specify that the unit leader must be the one to satisfy all the criteria for supervision of specific program activities. All Scouts BSA troops, Venturing crews, and Sea Scout ships who provide unit-level sponsored/planned range and target activities must have at least one registered unit leader 21+ years of age take the Range Activity SAFETY online training available on my.Scouting.org. This individual must be present at the range during the range and target activity(s). Participating in this training will help ensure a unit understands Scouting America's range and target activities policies.

For range and target activities, the unit leader may or may not hold specified certification(s) for the supervision of the range and in the case of Cub Scouting, range and target activities are not approved for a unit activity.

There are two main aspects of range supervision:

1. Range Management – Those individuals who are in charge of range safety and overseeing the shooting stations and participants. These people are responsible for following the approved Standard Operating Procedures (SOP) for the range and overall range supervision. This person is the safety officer.
2. Range Instruction – Those individuals whose primary concern is instruction in the type of shooting, referred to as a shooting discipline. This person is responsible to train in the proper use of and care for the equipment being used. This person may instruct advancement or recognition pieces. Their main responsibility is to instruct and foster competency in the participant.

This publication provides guidance on how to ensure proper safeguards are in place for a range and target activity, whether those safeguards are implemented by the facility operator or the unit. Skills and certifications are reviewed, as well as requirements for a proper facility. After reviewing this material, the leader should be confident in their ability to judge when a range and target activity is safe, when the risk is unacceptable, or when their background is insufficient to make that determination. Experienced, informed leaders develop a sense or intuition regarding an action. When an activity exceeds the leader's comfort zone, it should be curtailed or modified.

## Range and Target Activities Personnel Descriptions

Beginning September 1, 2024, the position previously titled "Shooting Sports Director" will be renamed "Range Activities Director." Individuals holding a valid certificate from the Shooting Sports Director section of the National Camping School retain their certification until it expires. Expiration dates are indicated on an individual's official National Camping School certificate card. In this manual, the title "Range Activities Director" may also refer to those previously certified as "Shooting Sports Directors," provided their certification remains valid.

### Range Activities Director

- Twenty-one years of age or older and currently certified with a valid certificate of training from the Range Activities Director or Shooting Sports Director section of National Camping School within the past five years.
- In charge of all range and target activities, including rifle, shotgun, muzzleloaders, throwing sports and archery during camp program.
- Manages staff that includes properly qualified instructors with current certifications and trains support staff.
- Sees that all areas are maintained and used properly, keeps an updated inventory of equipment, and is in charge of the safe and proper maintenance and use of this equipment.
- Can serve as a Range Safety Officer if the National Camping School certified Range Activities Director holds current NRA Range Safety Officer Certification.
- Can serve as an NRA Instructor if the National Camping School Range Activities Director holds current NRA Instructor certifications for the discipline for which supervision and instruction is required.

### **NRA Certified Instructor**

- Twenty-one years of age or older. Current NRA Instructor rating in the specific program for which supervision and instruction is required. The National Camping School Range Activities Director can be the NRA Instructor.

### **NRA Assistant Instructors**

- Eighteen years of age or older and holds current NRA assistant instructor's certificate in the appropriate discipline
- Can assist the NRA Instructor in supervising a range; however, this does not include running a live firing line.

### **NRA Range Safety Officer**

- Twenty-one years of age or older and holds current NRA Range Safety Officer credentials
- In charge of the firing line at any time it is in operation
- May not leave the firing line at any time while it is in operation

### **Range and Target Activities Program Counselors and Aides**

- Sixteen years of age or older and trained for specific duties by a National Camping School Range Activities Director
- Under on-site supervision of an NRA Range Safety Officer, may exercise crowd control, serve as training assistant for specified topics assigned by the NRA Range Safety Officer, move and maintain equipment, and act as a coach in a student coach/pupil setting
- May NOT supervise any live fire

### **Scouting America BB Gun Rangemaster**

- Eighteen years of age or older and trained by a National Camping School Range Activities Director or National Rifle Association rifle instructor
- Is in charge of the firing line at any time it is in operation
- BB gun rangemaster training must be renewed every two years, and this person must have a current Training Course Certificate, No. 33767

### **Scouting America Archery Director**

- 18 years of age or older
- An Archery Rangemaster who is trained by a National Camping School Range Activities Director or is instructor certified by the USA Archery using USA Archery Level 1 instructor course by a USA Archery Level 2 Instructor Trainer or a National Camping School Range Activities Director or a USA Level 1 Archery Instructor and would receive a Rangemaster certification.

- Responsibilities include the setup and operation of a safe archery range for Cub Scout, Scouts BSA, Venturing or Sea Scouting programs, Archery merit badge instruction, and management of an archery staff at camp.

### **Scouting America Archery Rangemaster**

- Eighteen years of age or older and trained by a National Camping School Range Activities Director or USA Archery Level 1 Archery Instructor to set up and operate a safe archery range for a Cub Scouts, Scouts BSA, Venturing or Sea Scouting archery program according to the standards located in this manual, "Archery and BB Guns."
- Archery rangemaster training must be renewed every two years, and this person must have a current Training Course Certificate, No. 33767.

### **Council Range and Target Activities Coordinator/Chair**

- 21 years old or older. National Camping School certification as a Range Activities Director is recommended.
- National Rifle Association certified instructor for one or more of the appropriate disciplines is recommended.
- Current NRA Range Safety Officer or NRA Chief Range Safety Officer certification is recommended.
- USA Archery Level 1 Archery Instructor certification recommended.

### **Definition of "Instructor Qualified"**

**To be instructor qualified means the individual holds one or more of the following certifications depending on the discipline.**

Trained and currently documented by:

- Scouting America National Camping School as a Range Activities Director for rifle, shotgun, co-op muzzleloading rifle, and archery.
- The National Rifle Association as a currently certified instructor for the specific discipline where instruction is taking place (rifle, shotgun, pistol, co-op muzzleloading rifle, or NRA/NMLRA muzzleloading instructor)
- USA Archery as a currently certified USA Archery Level 1 instructor or higher.

A copy of the current training certificate or document is to be on file at the local council office and/or camp.

The following Chart describes the disciplines for Scouting programs, and the supervision required to operate these programs. All range and target activities must follow the guidelines of the Guide to Safe Scouting and the age appropriate guidelines of Scouting America.

Program	Participants	Safety equipment	Minimum program supervision requirements	Qualified staff to open the range	Minimum number of staff to operate	Ratio instructor : participant	Additional information
BB (Scouting America Accredited Camp)*	All program levels <i>except</i> Lion Cub Scouts	Eye Protection	BB gun Rangemaster	BB Gun Rangemaster National Camping School Range Activities Director NRA Rifle Instructor Certified Military shooting instructor** Certified Law Enforcement Shooting Instructor** Certified 4-H Shooting Instructor**	1 qualified staff and appropriate assistants	1:1 adult to participant for Tiger Cubs 1:8 all others	Cub Scout participation at District or Council events Only
BB (Unit Activity)	Scouts BSA, Venturing, Sea Scouting	Eye protection	BB gun Rangemaster	BB Gun Rangemaster National Camping School shooting Sports Director NRA Rifle Instructor	1 qualified staff and appropriate assistants	1:8	Not approved as a Cub Scout unit activity
Slingshot (Scouting America Accredited Camp)*	All program levels	Eye Protection	BB gun Rangemaster	BB Gun Rangemaster National Camping School Range Activities Director NRA Rifle Instructor Certified Military shooting instructor** Certified Law Enforcement Shooting Instructor** Certified 4-H Shooting Instructor**	1 qualified staff and appropriate assistants	1:1 adult to participant for Cub Scout (all levels) 1:4 adult to participant Scouts BSA, Venturing, Sea Scouting	Cub Scout participation at District or Council events Only
Slingshot (Unit Activity)	Scouts BSA, Venturing, Sea Scouting	Eye Protection	BB gun Rangemaster	BB Gun Rangemaster National Camping School Range Activities Director NRA Rifle Instructor	1 qualified staff and appropriate assistants	1:4 adult to participant	Not approved as a Cub Scout unit activity
Pellet Rifles	Scouts BSA, Venturing, Sea Scouting, Webelos and Arrow of Light Scouts (Long-term camp only)	Eye Protection	NRA Rifle Instructor	National Camping School Range Activities Director NRA Rifle Instructor Certified Military shooting instructor** Certified Law Enforcement Shooting Instructor** Certified 4-H Shooting Instructor**	1 qualified staff and appropriate assistants	1:8	Webelos Scouts and Arrow of Light Scouts may use pellet rifles on a council operated range while attending a long-term camp. All pellet rifles (CO2, pump, break barrel, etc.) are limited to singleshoot, designated for target shooting, velocity of 500 to 540 feet per second, with a minimum of 2.5 pound trigger pull. See also Multigun Airsoft Experience Operations Guide in appendix for additional operational guidance.

\*Scouting America accredited camp means, Day Camp, Short-term Camp and Long-term camp following the NCAP standards. If a council or district has a day activity, standards for “unit activity” apply. Unless otherwise stated the supervision standard is the same for a camp or unit activity with the exception of NRA FIRST Steps Pistol Orientation. This program is not approved for unit sponsored events or activities. | \*\*Requires approved waiver. In addition, if these positions are used, these individuals need to also be familiar with and follow the program outlined in the Cub Scout Range and Target Activities Guide located in Appendix 5 of this manual. | † Required waiver for long-term camp only

Program	Participants	Safety equipment	Minimum program supervision requirements	Qualified staff to open the range	Minimum number of staff to operate	Ratio instructor: participant	Additional information
Rifle (Scouting America Accredited Camp)	Scouts BSA, Venturing, Sea Scouting	Eye and hearing protection	NRA Rifle Instructor	National Camping School Range Activities Director NRA Rifle Instructor† Certified Military shooting instructor** Certified Law Enforcement Shooting Instructor** Certified 4-H Shooting Instructor**	Long-term camp: 1 qualified staff and appropriate assistants Short-term camp and Day Camp: NCS Range Activities Director (1 person) OR NRA Rifle instructor AND NRA RSO (2 people)	1:8	See also current NCAP standards
Rifle (Unit activity)	Scouts BSA, Venturing, Sea Scouting	Eye and hearing protection	NRA Rifle Instructor AND NRA Range Safety Officer	National Camping School Range Activities Director NRA Rifle Instructor AND NRA Range Safety Officer	2 people (RSO and at least one instructor)	1:8	
Shotgun (Scouting America Accredited Camp)	Scouts BSA, Venturing, Sea Scouting	Eye and hearing protection	NRA Shotgun Instructor	National Camping School Range Activities Director NRA Shotgun Instructor† Certified Military shooting instructor** Certified Law Enforcement Shooting Instructor** Certified 4-H Shooting Instructor**	Long-term camp: 1 qualified staff and appropriate assistants Short-term camp and Day Camp: NCS Range Activities Director (1 person) OR NRA Shotgun instructor AND NRA RSO (2 people)	1:6 for instruction 1:1 when loading and firing	Instructor maintains control of ammunition See also current NCAP standards

\*Scouting America accredited camp means, Day Camp, Short-term Camp and Long-term camp following the NCAP standards. If a council or district has a day activity, standards for “unit activity” apply. Unless otherwise stated the supervision standard is the same for a camp or unit activity. | \*\*Requires approved waiver | † Required waiver for long-term camp only



Program	Participants	Safety equipment	Minimum program supervision requirements	Qualified staff to open the range	Minimum number of staff to operate	Ratio instructor : participant	Additional information
Shotgun (Unit Activity)	Scouts BSA, Venturing, Sea Scouting	Eye and hearing protection	NRA Shotgun Instructor AND NRA Range Safety Officer	National Camping School Range Activities Director NRA Shotgun Instructor AND NRA Range Safety Officer	2 people (RSO and at least one instructor)	1:6 for instruction 1:1 when loading and firing	Instructor maintains control of ammunition
NRA FIRST Steps Pistol Orientation Program (council or district sponsored camps or day events).	Scouts BSA (14 or 13 and completed 8th grade), Venturing, Sea Scouting	Eye and hearing protection	NRA Pistol Instructor and NRA Range Safety Officer	NRA Pistol Instructor AND NRA Range Safety Officer	2 people (RSO and at least one instructor)	1:6 for instruction 1:1 when loading and firing	Not approved as a unit activity. Instructor maintains control of ammunition.
Muzzleloading Rifle (Scouting America accredited Camp)	Scouts BSA, Venturing, Sea Scouting	Eye and hearing protection	NRA Co-Op Muzzleloading Rifle Instructor	National Camping School Range Activities Director with current NRA Co-Op muzzleloading rifle instructor certification OR NRA/NMLRA certified muzzleloading instructor	Long-term camp: 1 qualified staff and appropriate assistants. Short-term camp and Day Camp: NCS Range Activities Director with current NRA Co-Op Muzzleloading rifle instructor certification (1 person) OR NRA/NMRLA certified Muzzleloading instructor AND NRA RSO (2 people)	1:8 for instruction 1:1 when loading and firing	
Muzzleloading Rifle (Unit Activity)	Scouts BSA, Venturing, Sea Scouting	Eye and hearing protection	NRA Co-Op Muzzleloading Rifle Instructor AND NRA RSO (2 people)	National Camping School Range Activities Director with current NRA Co-Op muzzleloading rifle instructor certification OR NRA/NMLRA certified muzzleloading instructor	2 people (RSO and at least one instructor)	1:8 for instruction 1:1 when loading and firing	
Muzzleloading shotgun (Scouting America accredited camp)	Scouts BSA, Venturing, Sea Scouting	Eye and hearing protection	NRA/NMLRA certified muzzleloading instructor	NRA/NMLRA certified muzzleloading instructor	Long term camp: 1 qualified staff and appropriate assistants Short-term camp and Day Camp: 2 people (RSO and at least one instructor)	1:6 for instruction 1:1 when loading and firing	
Muzzleloading shotgun (unit activity)	Scouts BSA, Venturing, Sea Scouting	Eye and hearing protection	NRA/NMLRA certified muzzleloading instructor AND NRA RSO (2 people)	NRA/NMLRA certified muzzleloading instructor	2 people (RSO and at least one instructor)	1:6 for instruction 1:1 when loading and firing	

Program	Participants	Safety equipment	Minimum program supervision requirements	Qualified staff to open the range	Minimum number of staff to operate	Ratio instructor : participant	Additional information
Archery (Scouting America Accredited Camp)	All program levels	Arm guards on bow arm, finger protection	Archery Rangemaster	Archery Rangemaster for Cub Scout; OR USA Archery Level 1	1 qualified staff and appropriate assistants	1:8 Not approved as a Cub Scout unit activity.	
Archery (unit activity)	Scouts BSA, Venturing, Sea Scouting	Arm guards on bow arm, finger protection	USA Archery Level 1 or higher	USA Archery Level 1 or higher	1 qualified staff and appropriate assistants	1:8	
Tomahawks/ knives	Scouts BSA, Venturing, Sea Scouting	Eye protection	Responsible adult (18+) familiar with the use of tomahawk/knife throwing	Responsible adult (18+) familiar with the use of tomahawk/knife throwing	1 qualified staff and appropriate assistants	1:4	Activity must be approved by a council Range and Target Activities committee chair or National Camping School Range Activities Director. Not approved as a Cub Scout unit activity.
Catapults (see catapults in chapter 10)	All program levels (as appropriate)	Eye protection	NRA Range Safety Officer				Activity must be approved by council range and target activities chair or National Camping School Range Activities Director.
Chalkball/ Paintball (council or district sponsored camps or day events)	Scouts BSA, Venturing, Sea Scouting	Eye and hearing protection	NRA Range Safety Officer	NRA RSO	1 qualified staff and appropriate assistants	1:1	See also Chalkball Shooting Program Guide, in the appendix. Council must apply to operate this activity.
Multi-gun Airsoft experience	Scouts BSA, Venturing, Sea Scouting	Eye Protection	BB Gun Rangemaster with Airsoft endorsement Coach (authorized by airsoft instructor) Volunteer (as needed for event)	BB Gun Rangemaster with Air Soft endorsement National Camping School Range Activities Director NRA Rifle Instructor with Airsoft endorsement	2 qualified staff and appropriate assistants	1:1 1 Instructor per bay 1 Coach per bay	See also Multi-gun Airsoft Experience Operations Guide, in the appendix. Airsoft endorsement is conducted through the council Range and Target Activities committee. Council must apply to operate this activity.
Sporting arrows (council or district sponsored camps or day events)	Scouts BSA, Venturing, Sea Scouting	Arm guards on bow arm, finger protection	USA Archery Level 1 or higher instructor	USA Archery Level 1 or higher instructor	1 qualified staff and appropriate assistants	1:3	See also Sporting Arrows Shooting Program Guide in the appendix. Council must apply to operate this activity

Program	Participants	Safety equipment	Minimum program supervision requirements	Qualified staff to open the range	Minimum number of staff to operate	Ratio instructor : participant	Additional information
Cowboy action (council or district sponsored camps or day events)	Scouts BSA (14 or 13 and completed 8th grade), Venturing, Sea Scouting	Eye and hearing protection	NRA certified instructor for each discipline AND NRA RSO	National Camping School Range Activities Director with current appropriate endorsements Appropriate NRA instructor for each firearm (separate certifications required for each firearm)	Long-term camp: 1 appropriately NRA certified staff at each station and appropriate assistants Short-term and Day Camp: 1 appropriately NRA certified staff at each station and appropriate assistants AND NRA RSO	1:1	See also Cowboy Action Shooting Program Guide, in the appendix. Council must apply to operate this activity.

## FIVE LEVELS OF SHOOTING ACTIVITIES

The “Five Levels” have been developed as a planning guide to organize and conduct a safe Scouting range and target activity. Included are the major firearm disciplines: rifle, pistol, shotgun, and muzzleloading. For each discipline, you will find the necessary topics that should be considered as you plan your event.

In general, the five levels are:

1. A first-time shooting experience
2. Open shooting experience
3. Ongoing shooting experience
4. Competitive shooting
5. Becoming an instructor

Whether a Scout unit is going to the camp property or gun club range or participating in a shooting event at a district or council short-term camp, these guidelines are to be followed by those in charge of the gun shooting activity. In all cases Scouting America guidelines for Youth Protection and supervision must be followed.

- Scouting America’s BB gun program is not included in the Five Levels for Rifle Shooting. Refer to this manual for information on Cub Scout BB gun shooting.
- Scouting America does not allow the use of any fully automatic firearms in its shooting sports program.
- Note that many commercial ranges may have stricter procedures that will take precedence over Scouting America rules. These stricter rules are the minimum acceptable for Scouting America range and target activities at those ranges.

## 5 LEVELS OF: RIFLE SHOOTING

	Level 1 Air Rifle Shooting Experience	Level 2 Rifle Open Shooting Experience	Level 3 Rifle Ongoing Shooting Program	Level 4 Competitive Level	Level 5 NRA Assistant Rifle Instructor or NRA Assistant Coach
<b>Purpose</b>	Introduce & recruit youth to the BSA and the Scouting America Range and Target Activities program.	Introduce and recruit Scouts into Shooting Sports programs Ex. Fun Shoot Day or open shoot	Introduce and recruit Scouts into year-round Shooting Sports programs Ex. Range and Target Activities MB or Venturing awards	Promote competition among Scouts BSA, Venturers, and Sea Scouts	Scouts BSA, Venturers, and Sea Scouts to take a leadership role in their unit as an NRA Apprentice or Assistant Instructor
<b>Youth</b>	Minimum age 10 years		Scouts BSA, Venturers, Sea Scouts		
<b>Equipment</b>	.177 caliber pellet rifle, min 2.5 lb trigger pull (open, scope or dot sights); air, CO2, or precharged pneumatic	.177 caliber pellet rifle, min 2.5 lb trigger pull (open, scope or dot sights); air, CO2, or precharged pneumatic .22 caliber rimfire* (breech-loading, single shot, bolt action or repeater bolt action with box magazine**), trigger pull min 3 lbs	As required by the competition	Rifle meeting minimum requirements for course being taught	
<b>Ammunition</b>	.177 caliber pellets	Correct caliber for range and equipment being used. Reloading and use of reloaded ammunition is not approved for Scouting America programs. Tracer, armor-piercing and exploding ammo are not allowed.			
<b>Range</b>		Scouting America camp property approved range, Commercial Firearm Range, Portable range (pellet rifle only), Temporary safety enclosure (pellet rifle only)			
<b>Training for Participants</b>	Five minutes of 3 rules of gun safety, Rifles assigned to shooting station, Rifles are loaded by instructors, Youth point at target and fire	Scouting America 30-minute rifle briefing	Rifle Shooting Merit Badge OR NRA Basics of Rifle Shooting Course	NRA Basics of Rifle Shooting Course	NRA Rifle Instructor Course
<b>Targets</b>	Bull's-eye targets (large with carrier system), Resetting metallic, Balloons, Other breakable targets no exploding targets	Paper, Balloons, Resetting metallic, Other breakable targets Exploding targets not allowed		As determined by competition Exploding targets not allowed	Mandated by course being taught
<b>Course</b>	Bench rest, prone, or standing position only (bench rest recommended)	Bench rest, Prone, Standing, Kneeling, Sitting	Following requirements of Rifle Shooting Merit Badge or Venturing Ranger Award NRA qualification program	Competition Rule Book (Scouting America youth protection policies must also be followed.)	NRA Rifle Instructor Course
<b>Safety Equipment</b>	Eye protection		Eye protection (pellet rifles); Eye and hearing protection		
<b>Instructor</b>	National Camping School Range Activities Director holding NRA rifle instructor certification OR an NRA Certified Rifle Instructor			Provided by venue	NRA training counselor
<b>Range Supervision</b>		See chart in Chapter 1		Based on the rules of the approved competition	Based on course being taught
<b>Ratio</b>		1:8 - NRA Range Safety Officer and 1:8 - Instructor (2 separate persons)		Based on the rules of the approved competition	Based on course being taught
<b>Notes</b>	Event may be a pellet rifle range set up at a community event, county or state fair, etc.	NRA Marksmanship Qualification Program may be introduced			

\* A commercial firearm range is a supervised facility that offers a controlled environment for safe firearm practice. It will provide shooting lanes, targets, and may offer equipment rentals and training in safe firearm handling and marksmanship. Standard operating procedures are required for each firearm type used on-site. Scouting's range and target activities must follow all of Scouting's range and target activities policies or range standard operating procedures that are equivalently stringent, including no variation from Scouting's limitations on firearms used. These ranges may be operated by a licensed business, a government entity or non-profit.

## 5 LEVELS OF SHOTGUN SHOOTING

	Level 1 Shotgun Shooting Experience	Level 2 Shotgun Open Shooting Experience	Level 3 Shotgun Ongoing Shooting Program	Level 4 Competitive Level	Level 5 NRA Assistant Shotgun Instructor
<b>Purpose</b>	There is no Level 1 Shotgun Shooting Experience	Introduce and recruit Scouts into Range and Target Activities	Introduce and recruit Scouts into year-round range and target activities	Promote competition among Scouts BSA, Venturers, and Sea Scouts	Scouts BSA, Venturers, and Sea Scouts to take a leadership role in their unit as an NRA Apprentice or Assistant Instructor
<b>Youth</b>		Scouts BSA, Venturers, Sea Scouts			
<b>Equipment</b>		Youth and adult-size gas operated semi-automatic shotguns are recommended. Recommended gauges are 20 or 12		As required by the competition	Per the course being taught
<b>Ammunition</b>		Correct ammunition for range and equipment being used Reloading and use of reloaded ammunition is not approved for Scouting America programs. Tracer, armor-piercing and exploding ammo are not allowed.			
<b>Range</b>		Scouting America camp property approved range, Commercial Range*			
<b>Training for Participants</b>		Scouting America 30-minute shotgun briefing	Shotgun Merit Badge (Scouts BSA) OR NRA Basics of Shotgun Shooting Course	NRA Basics of Shotgun Shooting Course	NRA shotgun Instructor Course
<b>Targets</b>		clay targets			
<b>Course</b>		Single Shell - slow, straight away, and incoming targets.	Following requirements of Shotgun Shooting Merit Badge OR Venturing Ranger Award NRA qualification program	Competitive Rule Book for the competition (Scouting America youth protection policies must also be followed.) Load shells per course of fire (Ex. skeet, where 2 shot shells are loaded)	Following requirements of the NRA shotgun Instructor Course
<b>Safety Equipment</b>		Eye and hearing protection			
<b>Instructor</b>		National Camping School Range and Target Activities Director holding NRA shotgun instructor certification OR an NRA certified shotgun instructor.	National Camping School Range Activities Director holding NRA shotgun instructor certification OR NRA certified shotgun instructor OR NRA certified shotgun coach OR specific competition supervision required	National Camping School Range Activities Director holding NRA shotgun instructor certification OR NRA certified shotgun instructor OR NRA certified shotgun coach OR specific competition supervision required	NRA training counselor
<b>Range Supervision</b>		See chart in Chapter 1		Based on the rules of the competition	Based on course being taught
<b>Ratio</b>		1:6 - NRA Range Safety Officer and 1:1 - Instructor (2 separate persons)		Based on the rules of the competition	Based on course being taught
<b>Notes</b>		This event can be a shooting day at the range shoot, NRA Day event or NRA Marksmanship Qualification Program may be introduced. A Scouting America short-term camp could also be appropriate. For the Scouts BSA Shotgun Merit Badge, the instructor maintains strict control over the ammunition, ensuring that only one shotgun shell is loaded at a time, with no more than one shotgun loaded per instructor.			

\* A commercial firearm range is a supervised facility that offers a controlled environment for safe firearm practice. It will provide shooting lanes, targets, and may offer equipment rentals and training in safe firearm handling and marksmanship. Standard operating procedures are required for each firearm type used on-site. Scouting's range and target activities must follow all of Scouting's range and target activities policies or range standard operating procedures that are equivalently stringent, including no variation from Scouting's limitations on firearms used. These ranges may be operated by a licensed business, a government entity or non-profit.

# PISTOL SHOOTING

## Level 1

<b>Purpose</b>	NRA FIRST Steps Pistol Orientation Shooting Experience
<b>Youth</b>	Older Scouts BSA, Venturing, Sea Scouting Minimum Age 14 years or 13 years and completed the 8th grade
<b>Equipment</b>	.177 pellet pistol, .22-caliber long rifle rimfire pistol, .38-caliber special, or 9 mm pistol
<b>Ammunition</b>	Correct ammunition for range and equipment being used. Reloading and use of reloaded ammunition is not approved for BSA programs. Tracer, armor-piercing and exploding ammo are not allowed.
<b>Range</b>	Scouting America Camp Property Approved Range, Commercial Range*
<b>Training for Participants</b>	NRA FIRST Steps Pistol Orientation
<b>Targets</b>	As defined by NRA FIRST Steps Pistol Orientation
<b>Course</b>	NRA FIRST Steps Pistol Orientation Course
<b>Safety Equipment</b>	Eye and Hearing Protection
<b>Instructor</b>	NRA certified Pistol instructor
<b>Range Supervision</b>	Certified NRA Range Safety Officer AND NRA certified Pistol instructor; Must be 2 separate individuals
<b>Ratio</b>	1:6 Range Safety Officer; 1:1 Instructor (2 separate persons)
<b>Notes</b>	Pistol shooting is not an approved unit level sponsored activity. The only pistol shooting program in Scouting is the NRA FIRST Steps Pistol Orientation Shooting Experience.

\* A commercial firearm range is a supervised facility that offers a controlled environment for safe firearm practice. It will provide shooting lanes, targets, and may offer equipment rentals and training in safe firearm handling and marksmanship. Standard operating procedures are required for each firearm type used on-site. Scouting's range and target activities must follow all of Scouting's range and target activities policies or range standard operating procedures that are equivalently stringent, including no variation from Scouting's limitations on firearms used. These ranges may be operated by a licensed business, a government entity or non-profit.

## 5 LEVELS OF: MUZZLELOADING RIFLE SHOOTING

	Level 1 Muzzleloading Rifle Experience	Level 2 Muzzleloading Rifle Open Shooting Experience	Level 3 Muzzleloading Rifle Ongoing Shooting Program	Level 4 Competitive Level	Level 5 NRA Co-Op Muzzleloading Rifle Instructor
<b>Purpose</b>	There is no Level 1 Muzzleloading Rifle Experience	Introduce and recruit Scouts into range and target activities	Introduce and recruit Scouts into year-round range and target activities	Promote competition among Scouts BSA, Venturers, and Sea Scouts	Scouts BSA, Venturers, and Sea Scouts to take a leadership role in their unit as an NMLRA Instructor, NRA Co-Op Muzzleloading Rifle Instructor, or NRA Range Safety Officer
<b>Youth</b>			Scouts BSA Venturers Sea Scouts		
<b>Equipment</b>		Muzzleloading rifles in appropriate size for participant. Matchlock, wheellock or flintlock firearms are not approved.		Equipment will meet the requirements for the conventional and international muzzleloading rifle competitive programs. Matchlock, wheellock or flintlock firearms are not approved.	Muzzleloading rifle meeting minimum requirements for course being taught. Matchlock, wheellock or flintlock firearms are not approved.
<b>Ammunition</b>		Commercially manufactured	Correct ammunition for equipment being used Commercially manufactured projectile and components are the only types approved Commercially manufactured, sporting grade black powder or black powder substitute are the only approved propellants.		
<b>Range</b>			Scouting America camp property approved range Commercial Range*		
<b>Training for Participants</b>		Scouting America 30-minute muzzleloading rifle briefing	Basic instruction on loading and firing, range rules and safety for muzzleloading rifle	Basic muzzleloading rifle instruction including cleaning and maintenance	NRA Co-Op Muzzleloading Rifle Instructor course, NMLRA Instructor course, NRA Range Safety Officer course
<b>Targets</b>		Paper, Balloons, Resetting metallic, Other breakable targets Exploding targets not allowed	Paper, Balloons, Resetting metallic, Other breakable targets Exploding targets not allowed	Based on the rules of the competition	Based on the course being taught
<b>Course</b>		Bench rest, cross sticks, or standing Instructor follows the three-step method (EDGE)	Following requirements of the Rifle Shooting Merit Badge or Venturing Ranger Award	Competitive Rule Book for the competition (Scouting America youth protection policies must also be followed.)	NMLRA Instructor course, NRA/NMLRA Co-Op Muzzleloading Rifle Instructor course, NRA Range Safety Officer course
<b>Safety Equipment</b>			Eye and hearing protection		
<b>Instructor</b>		National Camping School Range Activities Director with current NRA Co-Op Muzzleloading Rifle Instructor Certificate OR an NRA/NMLRA certified muzzleloading instructor.		Based on the competition	NRA Training counselor
<b>Range Supervision</b>		NRA certification as an NRA Co-Op Muzzleloading rifle instructor OR an NRA- NMLRA instructor		Based on the rules of the competition	Based on course being taught
<b>Ratio</b>		1:8 - NRA Range Safety Officer and 1:1 - Instructor (2 separate persons)		Based on the rules of the competition	Based on course being taught
<b>Notes</b>		This event can be a shooting day at the range, NRA Day event or NRA Marksmanship Qualification Program may be introduced. A Scouting America short-term camp could also be appropriate.			

\* A commercial firearm range is a supervised facility that offers a controlled environment for safe firearm practice. It will provide shooting lanes, targets, and may offer equipment rentals and training in safe firearm handling and marksmanship. Standard operating procedures are required for each firearm type used on-site. Scouting's range and target activities must follow all of Scouting's range and target activities policies or range standard operating procedures that are equivalently stringent, including no variation from Scouting's limitations on firearms used. These ranges may be operated by a licensed business, a government entity or non-profit.



## 5 LEVELS OF: MUZZLELOADING SHOTGUN SHOOTING

	Level 1 Muzzleloading Shotgun Experience	Level 2 Muzzleloading Shotgun Open Shooting Experience	Level 3 Muzzleloading Shotgun Ongoing Shooting Program	Level 4 Competitive Level	Level 5 NRA/NMLRA Muzzleloading Shotgun Instructor
<b>Purpose</b>	There is no Level 1 Muzzleloading Shotgun Experience	Introduce and recruit Scouts into range and target activities	Introduce and recruit Scouts into year-round range and target activities	Promote competition among Scouts BSA, Venturers, and Sea Scouts	Scouts BSA, Venturers, and Sea Scouts to take a leadership role in their unit as an NRA/NMLRA muzzleloading instructor
<b>Youth</b>			Scouts BSA Venturers Sea Scouts		
<b>Equipment</b>		10 gauge or smaller muzzleloading shotgun			Muzzleloading shotgun meeting minimum requirements for course being taught
<b>Ammunition</b>		Correct ammunition for equipment being used Commercially manufactured projectile and components are the only types approved Shot size should be 7 1/2 or smaller			
<b>Range</b>		Commercially manufactured, sporting grade black powder or black powder substitute are the only approved propellants.			
<b>Training for Participants</b>		Scouting America camp property approved range Commercial Range*			
<b>Targets</b>	Scouting America 30-minute muzzleloading shotgun briefing	Clay Targets	Basic instruction on loading and firing, range rules and safety for a muzzleloading shotgun	Basic Muzzleloading Shotgun instruction including cleaning and maintenance	NRA/NMLRA muzzleloading instructor course
<b>Course</b>	Slow, straightaway targets	Clay Targets	Following requirements of the Shotgun Shooting Merit Badge Venturing Ranger Award NRA Marksmanship Qualification Regulation skeet, trap targets shot at 10, 16, or 20 yards	Clay targets and other targets approved for the competition	Clay targets and other targets approved for the competition
<b>Safety Equipment</b>			Eye and hearing protection		
<b>Instructor</b>		NRA/NMLRA certified muzzleloading instructor.		Based on competition	NRA Training counselor
<b>Range Supervision</b>		Certified NRA Range Safety Officer AND NRA/NMLRA certified muzzleloading instructor.		Based on the rules of the competition	Based on course being taught
<b>Ratio</b>		1:6 - NRA Range Safety Officer and 1:1 - Instructor (2 separate persons) May have one adult to run hand trap if applicable		Based on the rules of the competition	Based on course being taught
<b>Notes</b>		This event can be a shooting day at the range, NRA Day event or NRA Marksmanship Qualification Program may be introduced. A Scouting America short-term camp could also be appropriate.			

\* A commercial firearm range is a supervised facility that offers a controlled environment for safe firearm practice. It will provide shooting lanes, targets, and may offer equipment rentals and training in safe firearm handling and marksmanship. Standard operating procedures are required for each firearm type used on-site. Scouting's range and target activities must follow all of Scouting's range and target activities policies or range standard operating procedures that are equivalently stringent, including no variation from Scouting's limitations on firearms used. These ranges may be operated by a licensed business, a government entity or non-profit.

## CHAPTER 2: SCOUTING AMERICA RANGE AND TARGET ACTIVITIES — A WEALTH OF YEAR-ROUND OPPORTUNITIES

### CUB SCOUT PROGRAMS

Cub Scout range and target activities programs may be conducted only on a district or council level. Archery, slingshot and BB gun shooting are restricted to day camps, Cub Scout/Webelos Scout long-term camps, council-managed short-term camps, or to council or district sponsored activities where there are properly trained supervisors and all standards for Scouting America range and target activities are enforced. Archery, slingshot and BB gun shooting are prohibited at the pack level.

The use of pellet air rifles is restricted to Webelos Scouts and Arrow of Light Scouts in a long-term camp setting only.

### SCOUTS BSA, VENTURING AND SEA SCOUT PROGRAMS

Firearm programs may only take place on a nationally authorized camp property's range(s) or at a commercial firearm range. This does not apply to district or council programs that utilize BB devices, but applies to pellet rifles, airsoft (any type), rifles, pistols, shotguns, and muzzle loading rifles and shotguns. Some states, counties, or other jurisdictions may regulate BB guns as firearms depending on their design and capabilities. Councils must review and follow any local regulations before conducting programs.

The council's camp may be an ideal location for range and target activities. Here, safely designed ranges may be established for the long-term camping program. Under qualified leadership, Scouts, should be given a chance to participate in these skills year-round. Alert unit, district, and council leadership will discover community resources that will be available to units throughout the year. Local archery, National Rifle Association, and sportsmen's groups will often provide facilities and resources.

Scouts BSA, Venturing and Sea Scout members can shoot small-bore rifle, shotgun, muzzleloading rifle, muzzleloading shotguns, and archery following the five levels of shooting described in the chart in Chapter 1.

Scouts BSA members who are 14 years of age or older, or are 13 years of age and have completed the eighth grade, Venturing and Sea Scout members may participate in the NRA FIRST Steps Pistol Orientation sponsored by their council or district. No other pistol program is allowed, except for potential participation in approved council cowboy action programs. Pistol use is limited to pistols and revolvers as follows: .177 pellet pistol; .22 long rifle rimfire; .38 caliber special; or 9 mm only.

For information about the Scouts BSA Merit badge programs refer to the following publications:

- Rifle Shooting merit badge pamphlet, No. 35942
- Shotgun Shooting merit badge pamphlet, No. 35948.
- Archery merit badge pamphlet, No. 35856.

**Long-term and Short-term camp programs.** Scouting America camp programs offer a wide variety of range and target activities opportunities for Scouts. Each local council will serve as a resource for more information on what that council's camp offers.

**Hunter education** (Scouts BSA/Venturing and Sea Scouting). Contact your local department of natural resources for more information on hunter safety and education, or find information online at [www.hunter-ed.com](http://www.hunter-ed.com).

**Venturing Range and Target Activities Outstanding Achievement Award.** While working on the Ranger Range and Target Activities elective, Venturers and Sea Scouts are to complete one of the following disciplines: pellet pistol, air rifle, archery, muzzleloading rifle, shotgun, or small-bore rifle. However, Venturers and Sea Scouts who go beyond the basic requirement and complete five of the seven disciplines will earn the Venturing Range and Target Activities Outstanding Achievement Award. This medal and certificate are sponsored by many companies and organizations to recognize outstanding achievement in shooting sports.

For more information, go to <https://www.scouting.org/awards/awards-central/venturing-shooting/>

### ***Training Programs for Adults and Youth***

See Section IV on training in this book.

### ***Council Range and Target Activities Committees***

Your local council's range and target activities committee provides an opportunity to become involved in the shooting sports program on a year-round basis. Refer to Chapter 4 for more information on council range and target activities committees.

### ***NRA National Youth Shooting Sports Ambassadors***

The program offers participants a wide array of benefits, ranging from cash awards and travel opportunities to meeting national shooting celebrities. For more information on the NRA National Youth Shooting Sports Ambassador Program, visit [youthambassadors.nra.org](http://youthambassadors.nra.org)

## CHAPTER 3: MERIT BADGE COUNSELORS

### Range and Target Activities Merit Badge Counselor Requirements and Registration

To qualify as a range and target activities merit badge counselor, a volunteer must:

- Register annually with Scouting America as a Merit Badge Counselor.  
Rifle Shooting and Shotgun Shooting—The merit badge counselor must take responsibility to assure that all instruction involving the handling of firearms or live ammunition must be supervised by a certified individual as outlined in this guide or the Merit Badge pamphlet.
- In approving merit badge counselors, the local council advancement committee has the authority to establish a minimum, reasonable level of skills and education for the counselor of a given merit badge.
- For additional information about Merit Badge counselors see the latest edition of the Guide to Advancement <https://filestore.scouting.org/filestore/pdf/33088.pdf>

### Resources for Merit Badge Counselors

- Shotgun Shooting Merit Badge Teaching Guide. Refer to Appendix.
- Rifle Shooting Merit Badge Teaching Guide. Refer to Appendix.
- *Guide to Advancement*, No. 33088.
- Application for Merit Badge (blue card), No. 34124. This three-panel, blue, wallet-size card shows that the Scout has permission from their Scoutmaster to start working on a particular merit badge, records their progress, and when completed, provides a separate record for the Scout, the counselor, and the unit.
- *Scouts BSA Handbook for Boys*
- *Scouts BSA Handbook for Girls*
- A Guide for Merit Badge Counseling, No. 34532. This folder gives potential merit badge counselors an introduction to the advancement program and the merit badge counselor's role. It also lists all the current merit badge subjects.
- Merit Badge Counselor Information form, No. 34405. When attached to the Adult Application, this document specifies the merit badge subjects a counselor wants to coach and secures the counselor's agreement to follow the merit badge requirements and Scouting America policies. This form is available online at [www.scouting.org/filestore/pdf/34405.pdf](http://www.scouting.org/filestore/pdf/34405.pdf).

- Merit badge pamphlet series. The merit badge pamphlets are written for Scout-age youth. The information presented in the pamphlet will help the counselor understand what the Scout may be studying and the level of learning expected by Scouting America. The pamphlets may also contain suggestions for projects or demonstrations required to earn the merit badge. Once a Scout has started working on a merit badge, they may continue with the requirements in effect when the badge was started. The Scout is not required to meet newly introduced changes unless the national office places a specific timeline on the implementation of new requirements.

Range and target activity merit badge pamphlets include:

- *Rifle Shooting*, No. 35942
- *Shotgun Shooting*, No. 35948
- *Archery*, No. 35856



## **SECTION II**

### **BEYOND THE UNIT LEVEL**

In addition to Section I, the information contained in Section II through Section VI is necessary for individuals who are involved in the range and target activities outside the unit level. This includes NRA Instructors, NRA Range Safety Officers, National Camping School Range Activities Directors, council range and target activities chairs, council range and target activities committee members, council professionals, camping committees, camp rangers, and all others who are involved in organizing and assisting in the delivery of the various range and target activities throughout the year.



## CHAPTER 4: COUNCIL RANGE AND TARGET ACTIVITIES COMMITTEES

### Organization

It is strongly recommended that all local councils have a range and target activities committee. The purpose of the committee is to manage and provide resources to the council, the camping committee, and the council camps for all activities involving range and target activities whether during summer camps or during year-round opportunities. All range and target activities should be coordinated through the range and target activities committee to verify that a safe and responsible program is planned and conducted by properly trained and currently certified personnel.

### Responsibilities

#### ***Council Range and Target Activities Committee Chairman/ Coordinator***

The organization should be composed of a chairperson/ coordinator with a working understanding of Scouting America Short-term and Long-term camp programs, and the knowledge, skills, and attitude to organize and ensure safe range operation for each range and target activities program. The chairperson is appointed by the council president or their designee. The committee shall report to the council vice president for program, the camping committee chair, the health and safety chair, or the council risk management committee chair as appropriate for the individual council organization.

- An age of 21 years or older and National Camping School certification as a range activities director is recommended.
  - National Rifle Association certified instructor for one or more of the appropriate disciplines is recommended.
  - Current NRA Range Safety Officer or NRA Chief Range Safety Officer rating is recommended.
  - Current USA Archery Level 1 instructor certification is recommended.
  - Schedules meetings, preferably on a monthly basis, of the range and target activities committee and assigns individual committee member responsibilities. Keeps the council Scout Executive or a designee informed of committee actions.
  - Advises the summer camp National Camping School range activities director in ensuring all requirements in the national standards are being met.
  - Accompanies the area camp assessment team on the tour of the range facilities and answers any questions it has relating to compliance with the national standards.
- If requested by the Scout executive, their representative or the camp director submits an evaluation on the National Camping School range activities director and staff and makes a recommendation on their employment in the future.
  - Ensures adequate training sessions are conducted annually to certify BB gun and archery Rangemasters for Cub Scout day camp, short term camp or other council or district activities.
  - Assists the camp director in identifying and recruiting the range activities director for summer camp in the event of illness or emergency. Serves in this capacity as requested or appointed by the camp director.
  - Ensures compliance with all Scouting America/ NRA range and target activities standards for Cub Scout, Scouts BSA, Venturing, and Sea Scout programs on and off council property.
  - Maintains a current inventory of all council shooting sports equipment and supplies and provides copies to all interested persons.
  - Compiles on a timely basis a list of equipment and supplies needed for summer camp and year-round operation and submits it to the council executive or their designee for procurement.
  - Assists in developing and continuing review of range safety standard operating procedures.
  - Schedules range maintenance to ensure all range facilities and equipment meet Scouting America/ NRA standards prior to all uses.
  - Identifies adult Scouters to help in year-round shooting sports programs and ensures they hold the appropriate current NRA certification.
  - Maintains a current list of individuals with NRA and USA Archery certifications and National Camping School training.
  - Recommends fee structures for year-round use of range facilities and equipment.
  - Serves as a resource for range and target activities merit badges, unit range and target activities, or other council or district range and target activities.
  - Makes recommendations to the Scout executive or their designee on procurement of BB Guns, firearms, archery equipment, and supplies.
  - Working with the council executive, apply to the available grant programs in order to fulfill current and future range and target activities needs. Grant programs are available through USA Archery, the National Rifle Association, Friends of the NRA local banquets, and local gun and sportsman clubs.
  - Any other responsibilities as determined in cooperation with the council Scout executive and the council president or their designees.



## **Committee Members**

- Assist the council range and target activities committee chairman in performing the duties of the shooting sports committee.
- Committee members are nominated by the chairman and/ or other committee members, and are approved by the council president or their designee.
- NRA certified instructor in at least one of the NRA disciplines is recommended.
- NRA Range Safety Officer certification is recommended.
- Range and target activities committee members may be appointed to the council committee at large.

## **Directing Cub Scout Range and Target Activities in a Council Program**

- Know and strictly follow all the safety regulations related to BB guns, slingshots, throwing sports and archery.
- Train staff about safety regulations for all sports areas.
- Train all campers and leaders in the safety fundamentals.
- Check the performance and safety aspects of all areas.
- Restrict from using an area, any person who does not follow all safety instructions.
- Set up all areas in a practical, safe, and inviting manner.
- Always provide qualified supervision for each area.
- Train, schedule, and supervise staff to perform daily routines.
- Check the inventory of all range and target activities equipment. Check equipment to make sure there is enough equipment, and obtain any needed equipment.
- Keep an adequate stock of BB guns, slingshots, throwing sports and archery equipment on hand and be accountable for all inventories.
- Make sure equipment is properly stored and secured appropriately when not in use.
- Organize and promote individual and team competition.
- Report any and all operational and personnel problems to the appropriate staff who may be overseeing the program, camp or activity.
- If appropriate file a closing inventory, a closing report, and recommendations as instructed.

## **Safety Instruction Guidelines**

To be effective, instruction should use the EDGE method of instruction:

- Explain the safety and safe use of equipment
- Demonstrate proper techniques in equipment usage
- Guide participants in developing skills related to the specific discipline
- Enable participants to meet the goals of the intended program.

Give instruction in simple terms. Controversial methods should be omitted. Make it clear that only one method will be used and that while other methods may exist, there are specific procedures for the current range that must be followed. Instructors should exactly follow the method they teach.

Range and target activities skills must be learned by practice, with each participant learning the rules of safety and self-discipline by putting them into practice. Participants quickly learn that there is no place for foolishness, carelessness, or horseplay when they handle range and target equipment. The instructor must always be mindful of their responsibility to make safety rules thoroughly understood before, during, and after instruction and practice. At the same time, they must have warmth, patience, and understanding for the youth who may not understand an instruction or who finds a skill challenging.

## **Positive Aspects of Range and Target Activities**

From material by R.A. Soldivera, range and target activities consultant

- Range and target activities are part of the Olympic and Paralympic Games.
- Range and target activities do not require participants to start at an early age to be successful. A person may start in high school and compete on a national level before entering college.
- Age does not seem to be a factor in learning range and target activities. Range and target activities have had a national champion who was more than 60 years old, and one as young as 16 years old.
- Range and target activities are for everyone.
- Range and target activities may be conducted both indoors and outdoors.
- Range and target activities may be featured as both a winter sport and a summer sport.
- Range and target activities may offer individual participation, team participation, or both at the same time.
- Range and target activities are recognized as being safe with few injuries.
- Students who have participated in range and target activities report a marked improvement in their ability to concentrate when they apply the principles of these sports to their academic pursuits.
- Sportsmanship has been described as “the quality and conduct of a person who accepts victory and defeat graciously.” Range and target activities have a reputation for high sportsmanship conduct among their participants.
- People with physical disabilities can compete at high levels of competition in range and target activities.
- College scholarships are awarded in range and target activities.



## CHAPTER 5: RANGE OPERATION

In planning any range and target activities, consideration must be given to what equipment is required for that specific shooting discipline and venue. Care must be taken to provide, or arrange for, the safety of non-participants as well as personal protection of the participant. This chapter examines some of the items that should be considered.

The use of personal firearms and personal ammunition is prohibited in all Scouting programs at a camp property (see Standard SA-001). Personal firearms and personal ammunition may be used at a commercial firearm range, subject to restrictions regarding caliber, gauge, and action as described in this manual.

### General Equipment Common to All Scouting Program Levels and Range Disciplines

**Range safety flag.** As an indicator that the range is active, the range safety flag is to be displayed on a flagpole in a prominent place visible to approaching spectators and participants. Each range should have its own flagpole. It is recommended the flag be made of a bright red material approximately 48-by-36 inches in size. (This flag can be purchased from the NRA's online store.) The flag should be removed at the end of the shooting session.

**Eye and hearing protection.** Each participant must wear hearing and eye protection appropriate for the shooting discipline. Spectators in the immediate, designated area must also wear protection as appropriate. ANSI Z87.1 is the approved rating and the industry standard. Shooting sports safety glasses with this rating should be worn anytime safety glasses are prescribed.

This personal safety equipment may be provided by the event or furnished by the individual participant. If provided by the individual, the Range Safety Officer or NRA instructor should verify that eyeglasses have adequate lens area to offer protection. Hearing protection must fit properly

If eye and hearing protection is furnished by the event organizers, an assortment of sizes should be on hand to ensure proper fit. Youth sizes are available from many vendors of safety glasses. Earmuffs might be preferable to earplugs. When exchanging common-use items, be sure to clean and disinfect them before wearing them. Earplugs are NOT to be exchanged.

**Empty-chamber indicator.** An added safety measure while transporting or storing, or while the firearm is, UNLOADED AND NOT BEING USED ON THE FIRING LINE a visual empty-chamber indicator should be installed. Several commercial models are available which when installed in the chamber displays a brightly colored flag readily visible.

A simple alternate method is to use a piece of high-visibility, heavy monofilament trimmer line, cut approximately 12 inches longer than the barrel of the firearm. When inserted through the barrel, approximately 6 inches of line is visible at both the muzzle and the breech.

**Ammunition control.** A simple ammunition block, with an appropriate number of 15/64-inch-diameter holes drilled in a pattern of a multiple of five, should be used to control the ammunition being dispensed to the participants. Range personnel will load the blocks from the bulk ammunition storage, and issue only the number of rounds being fired for a given relay. If magazines are being used, range personnel will load magazine prior to distribution.

### Comfort items.

- Sling. A leather or web sling will aid participants in the prone, kneeling, and sitting positions. They are easily adjustable to each participant and will steady the participant.
- Prone mat. A padded shooting mat of approximately 30-by-60 inches should be provided at each prone shooting position.
- Kneeling roll. A piece of carpet remnant approximately 8 inches wide and tightly rolled and bound to approximately 4 to 6 inches in diameter may be placed under the ankle of the down leg when shooting in the kneeling position.

**First-aid kit.** A first-aid kit must be readily accessible to the range or classroom. It should be well stocked and include items appropriate for potential injuries unique to the specific range and target activities venue. A medical log must be included in each kit. Details of each incident should be recorded. Any injury requiring first aid of any kind must be recorded in the First Aid Log for camp if the activity is a part of a Council long term, short term or day camp and if required, submit an incident report. Expended materials should be replaced before the next activity. Contents should be monitored and replaced as needed.

**Emergency communications device.** The procedure to summon emergency help must be considered during planning and be verified before the start of the event. The details of the exact location should also be noted in the event of an emergency. All range personnel should be familiar with the emergency procedures of the event and understand how to reach help.

## Range Equipment Appropriate to Each Scouting Program Level

**NOTE: The Cub Scout range and target activities programs are authorized for District and Council events only and are not approved for use at the unit level. For approved shooting activities for each age level, refer to the age appropriate guidelines within the *Guide to Safe Scouting*.**

### BB Gun

**BB Gun.** Only a smoothbore, spring-type air gun propelling a coated steel ball projectile commonly known as a “BB” may be used.

**Target.** The target line is usually 16.5 feet from the firing line. The TQ-40 and AR-4 are the common targets for this distance. Paper plates or aluminum pie tins are also popular targets for Cub Scouts and training new shooters. Animal, zombie, and human form silhouettes are not approved for Cub Scout use. Appropriate animal silhouettes including wild game species normally hunted are appropriate for Scouts BSA, Venturers, or Sea Scout use. Zombie and human form silhouettes are not approved for use in any Scouting America range and target activities programs.

**Personal Protection.** All participants must wear eye protection.

### Pellet Rifle

**Pellet Rifle.** Spring, piston or pneumatic (single stroke, multi-pump, air, or CO2 gas) pellet rifles with rifled barrels bored for .177-caliber skirted pellets may be used. Pellet rifles (CO2, pump, break barrel, etc.) are limited to single-shot, designed for target shooting with a look comparable to approved .22 rifles. Rifles may be used by Webelos Scouts, Arrow of Light Scouts, Scouts BSA, Venturers and Sea Scouts. Webelos and Arrow of Light use is restricted to long-term camps only.

- The pellet rifle range meets or exceeds Scouting America and NRA recommendations and appropriate Scouting America Outdoor Programs/Properties design standards.
- All pellet rifles in good repair are provided. All pellet rifles used in Scouting America range and target activities have a trigger pull in excess of 2.5 pounds and are tested with a 2.5-pound weight or scale at least once a week while in use. If any trigger mechanism fails, the pellet rifle is immediately removed from service. Documentation of the tests is maintained.
- **Webelos and Arrow of Light Scouts Only:** All pellet rifles (CO2, pump, break barrel, etc.) are limited to single-shot designated for target shooting, velocity of 500 to 540 feet per second, and energy levels not to exceed 7.5 joules.

- Pellet rifle propellant is limited to CO2 cylinders or air compressor/scuba tanks. Refilling is conducted by qualified/trained adults with appropriate controls. If scuba tanks are used, each tank must be visually inspected annually and hydrostatically tested every five years by a qualified technician. Scuba tanks used for range and target activities purposes may not be used for scuba purposes.

**Pellet Rifle Target.** The target line is usually set at 33 feet from the firing line. The TQ-18 and AR-5 are the common targets for this distance. Paper plates or aluminum pie tins are also popular targets for training new shooters. Animal, zombie, and human form silhouettes are not approved for Webelos or Arrow of Light Scout use. Appropriate animal silhouettes including wild game species normally hunted are appropriate for Scouts BSA, Venturers, or Sea Scout use. Zombie and human form silhouettes are not approved use in any Scouting America range and target activities programs.

**Personal Protection.** All participants must wear eye protection.

### Rifle

#### Rifle.

**Scouts BSA, Venturing and Sea Scouts.** May only use .22 caliber breech-loading, single-shot or a repeater type bolt-action rifles with a box-style magazine. (Only .22 caliber Short, long, long rifle may be used.) (Rifle tubular magazines are not allowed.) \*Note: Tubular magazines may be used in approved Cowboy action programs only following the guidelines in the Cowboy action guide in the appendix of this manual. Councils must be approved by the National Council to offer Cowboy action programs using the NCAP Intent to Operate form each year.

**Ammunition.** Current-manufacture cartridges appropriate for the caliber firearm being used. **Reloading and use of reloaded ammunition is not approved for Scouting America programs. Tracer, armor-piercing and exploding ammo are not allowed.**

#### Sights.

- Open sights found on most rifles are limited to elevation adjustment.
- Aperture (peep) sights are fully adjustable and have an easy-to-learn sight picture. The easy adjustment will aid in qualification shooting.
- Optical (red dot, telescopic) sights are also fully adjustable.

**Targets.** TQ-1, TQ-5, and A-17 targets are recommended at 50 feet. The A-23 is a popular small-bore rifle target at 50 yards and the A-25 is sized for 100 yards. Scouts BSA, Venturers, and Sea Scouts are allowed to use tasteful and appropriate animal silhouette targets (paper and 3-D targets) with all firearms approved for their use. Appropriate animal silhouettes

include wild game species that are normally hunted. Human form and zombie silhouette targets are not approved for use. Metallic silhouette animal targets are also approved for use.

Exploding targets are NOT approved for ANY shooting activity.

**Personal Protection.** All participants must wear eye and hearing protection.

### **Shotgun**

**Shotgun.** Modern, age-appropriate, target shotgun models, 12-, 16- or 20-gauge, may be used. Experience shows that beginning shotgun participants are more successful with a 20- or 12-gauge shotgun, putting more shot to the target.

**Chokes.** At the muzzle end of the shotgun is a “choke.” Just as the nozzle of a garden hose determines the width of a jet of water, the choke affects the spread pattern of the pellets exiting from the barrel. There are four main chokes: skeet, IC (improved cylinder), M (modified), and F (full). For camp use, skeet and IC are recommended. If these are not available, modified would be the best choice.

**Ammunition.** Current-manufacture shotshells of the appropriate gauge contain No. 7½ to No. 9 shot. A shot size larger than 7½ is not to be used. **Reloads may not be used in Scouting America range and target activities programs.**

**Trap/thrower.** Hand throwers, manual traps, or automatic traps may be used. Care should be taken to match the target speed and flight path to the shooter’s ability. Always refer to the manufacturer’s operations and safety instructions before operating this equipment.

**Trap location.** For new shooters and merit badge qualification, the trap should present a straight-away, rising target, at a reasonable speed. Trap systems on trap and skeet fields and on sporting clays courses will provide the participant with some challenging presentations as skills are mastered.

**Personal Protection.** All participants must wear eye and hearing protection.

### **Muzzleloading Firearms**

Because of the historical significance of muzzleloading firearms, Scouts BSA members, Venturers, and Sea Scouts are encouraged to learn to safely load and shoot a muzzleloader. On the range, each participant must be under the direct supervision (one-on-one) of a currently certified NRA or NRA/NMLRA muzzleloading instructor (for the appropriate discipline) when loading or firing the muzzleloader.

**Scouts BSA, Venturing and Sea Scouts. May only use muzzleloading rifles or muzzleloading shotguns. (No muzzleloading handguns are permitted in the Scouting America program.)**

**Muzzleloading rifles.** Recently manufactured (or assembled from a kit) percussion cap muzzleloading rifles or inline muzzleloading rifles of any caliber may be used. All muzzleloading rifles are subject to safety inspection by the instructor or range officer. Rifles made from kits must be checked by a qualified gunsmith.

**Propellant.** Only a commercially manufactured, sporting-grade black powder or black powder substitute offered for sale by a reputable firm should be used in muzzleloading firearms. For new shooters, the amount of propellant in grains should be at the minimum of the gun manufacturer’s recommended load range.

#### **Accessories.**

- **Ramrod.** The ramrod is used to seat the patch and shot. It is usually mounted in the fore-end of the stock, just beneath the barrel. It is recommended that a more durable work rod be obtained for use on the range. The first time a new rod is used, it should be inserted into the empty barrel all the way down. A permanent mark should be scribed on the rod at the end of the muzzle. Then the same procedure should be used after a standard charge (powder, patch, and ball) has been placed in the barrel. This will enable the shooter to know whether the barrel is empty or has a standard charge.
- **Powder flask and powder measure.** Propellant shall be transferred from the original bulk container to a brass or plastic powder flask to be taken to the range. It shall then be poured into the powder measure before pouring into the barrel.
- **Shot starter.** (ml rifle) This tool allows the shooter to first get the ball and patch just started into the muzzle, and second to drive the ball a short distance down the barrel, before using the ramrod to seat the patch and ball against the powder charge.
- **Shot measure.** (ml shotgun) A small cup with a handle that allows the shooter to measure the exact amount of shot and then pour it directly into the barrel.
- **Nipple wrench and nipple pick.** The nipple wrench is simple tool used to remove the cap nipple should it become fouled. A nipple pick is a stiff wire that is used to clear debris in the nipple orifice (flash channel).
- **Capper.** Percussion caps are packaged 100 per tin. The capper allows the caps to be dispensed one at a time right onto the nipple.
- **Patch puller, ball puller.** These tools fit onto the end of the ramrod to remove the ball or patch from down in the barrel. Care must be taken when using these items.

- **CO<sub>2</sub> ball discharger.** This tool has a fitting to fit onto the nipple and has a small CO<sub>2</sub> cartridge to provide pressure to blow a patch and ball out of the muzzle of the gun. **Always point the muzzle-loader in a safe direction when using this device.**
- Loading bench. Many Scout ranges are equipped with a loading bench that provides a stable and easy-to-reach platform for the muzzleloading firearm during the loading process.

**Personal Protection.** All participants must wear eye and hearing protection.

### **Pistols**

**Scouts BSA members who are 14 years of age or older, or are 13 years of age and have completed the eighth grade, Venturing and Sea Scouts may participate in the NRA FIRST Steps Pistol Orientation sponsored by the district or council. No other pistol program is allowed, except for potential participation in approved council cowboy action programs. No unit level sponsored pistol program is approved in any Scout America programs.**

**Handguns of any type are NOT permitted for Cub Scouting.**

**Pistols and Revolvers.** Pistol use is limited to pistols and revolvers as follows: .177 pellet pistol; .22 long rifle rimfire; .38 caliber special; or 9 mm only.

**Sights.** Open sights may be fixed or adjustable. Optical sights (red dot and telescopic) sights are also fully adjustable, but care must be taken to provide an appropriate scope for the shooting distance. Laser sights have become extremely popular as a training aid for pistol shooting; however, they may not be permitted for certain qualification programs.

**Targets.** A 9-inch paper plate is recommended for training new shooters at 15 feet. The TQ-6, slow-fire, and TQ-7 rapid-fire targets are recommended at 25 feet. B-2, slow-fire, and B-3, timed and rapid-fire are popular pistol targets at 50 feet. The B-16, slow-fire, and B-8, timed and rapid-fire, targets are sized for 25 yards. Appropriate animal silhouettes include wild game species that are normally hunted. Human form and zombie silhouette targets are not approved for use. Metallic silhouette is becoming a popular target discipline at many clubs and ranges. **NO exploding targets are allowed in any Scouting America program.**

**Personal Protection.** All participants must wear eye and hearing protection.

**Pointing any type of firearm or simulated firearm at any individual is unauthorized. Units with council approval may participate in formally organized historical reenactment events where firearms are used and intentionally aimed over the heads of reenactment participants. Leaders and the council approvers for participation must complete the SAFE Checklist during planning for attendance or participation.**

### **Archery**

#### **Bows.**

**Cub Scouts.** A light-draw-weight (15- to 20-pound), 54-inch, take-down, recurve bow is recommended because the bow will fit many archers who have different lengths of draw.

**Scouts BSA.** A light-draw-weight (20- to 25-pound), 62-inch or 66-inch, take-down, recurve bow is recommended because the bow will fit many archers who may have different lengths of draw.

**Venturers and Sea Scouts.** A light-draw-weight (20- to 35-pound), 62-, 66-, or 70-inch, take-down, recurve bow is recommended because the bow will fit many archers who may have different lengths of draw.

All bows should be equipped with an arrow rest in good condition and with a proper-length, well-served, 10- to 12-strand string with properly placed nock locator.

Always inspect the bow for cracks and splinters, and the condition of the bowstring and serving.

A universal draw length bow is popular in youth programs because it provides all the advantages of a compound bow but with an adjustable draw weight to accommodate participants of all abilities.

True compound bows are not recommended at this level because they must be set up to fit each individual archer.

**Arrows.** Care should be taken to inspect arrows before use.

- **Shaft material.** Wood arrows are light but susceptible to warping and splintering. Fiberglass arrows are heavier, and more durable, and will last several seasons. Aluminum arrows are light and shoot true, but cannot be repaired if bent or kinked. Carbon fiber arrows are lighter, stronger, and preferred by most competitive shooters.
- **Length.** An appropriate length arrow for Cub Scout age youth will be approximately 24 to 26 inches. For Scouts BSA use will be approximately



26 to 30 inches. For Venturers and Sea Scout use, arrows will be approximately 28 to 32 inches. Care must be taken to avoid shooting an arrow that is too short for the archer or too short for the bow.

- **Point.** Arrows must be fitted with target points. No field points or broadheads.
- **Nock.** The nock should fit the serving of the bow being used. The arrow should not fall from the string if the nock opening is correct.
- **Fletching/vanes.** Either may be used; however, plastic vanes provide longer service with young participants.

#### **Personal protection.**

- **Quiver.** For each archer, either a personal side quiver or a ground quiver must be provided to store arrows during shooting.
- **Finger protection.** Archers must wear a finger tab or glove unless there are “no gloves” on the string.
- **Arm protection.** Each archer **must** wear an arm guard on the bow arm. Arm guards may be obtained in junior sizes for small arms.
- **All protective equipment must be properly sized for the archer.**

#### **Sights.**

- Not recommended for Cub Scouts.
- As the fundamentals of archery are learned, it is recommended that sights be added to the bow. Least expensive may be a simple quilter’s pin affixed at the sight window by foam tape applied to the back of the handle.
- Relatively inexpensive target sights may be added to the bow, which will be a tremendous aid to the shooter for qualifying or competition.

#### **Targets.**

**Cub Scouts.** It is recommended that large-diameter target mats and faces be used to ensure success and to reduce the number of lost arrows. Ethafoam mats are commercially available in 48-inch, 36-inch, and 32-inch diameters, with five-color target faces to match. Animal, zombie, and human silhouettes are not approved for Cub Scout use.

Set the target line at no more than 10 yards in front of the shooting line, adding to the success of young archers. The mat should be mounted relatively low to the ground to make it easier to extract arrows from the target.

**Scouts BSA.** It is recommended that large-diameter target mats and faces be used to ensure success and to reduce the number of lost arrows. Ethafoam mats are commercially available in 48-inch, 36-inch, and 32-inch diameters, with five-color target faces to match.

Scouts BSA participants are allowed to use tasteful and appropriate animal silhouette targets (paper and 3-D targets). Appropriate animal silhouette targets include wild game species that are normally hunted. Human form and zombie silhouettes are not approved for use.

**Venturers and Sea Scouts.** For new shooters, it is recommended that large-diameter target mats and faces be used to ensure success and to reduce the number of lost arrows. Ethafoam mats are commercially available in 48-inch, 36-inch, and 32-inch diameters, with five-color target faces to match. As Venturers and Sea Scouts develop skill, various target games and shooting distances may be introduced to provide a challenge for the participant. Venturers and Sea Scouts are allowed to use tasteful and appropriate animal silhouette targets (paper and 3-D targets). Appropriate animal silhouette targets include wild game species that are normally hunted. Human form and zombie silhouettes are not approved for use.





**SECTION III**  
**HEALTH AND SAFETY**





## CHAPTER 6: SAFETY

Scouting America adheres to its longstanding policy of teaching its youth and adult members the safe, responsible, and intelligent handling, care, and use of firearms, throwing equipment and bow and arrow in planned, carefully managed, and supervised programs.

Safe gun handling is of paramount importance. You must treat every firearm as if it were loaded. With that in mind, there are several universal rules of safe gun handling that must always be followed.

1. **Always** keep the gun pointed in a safe direction.
2. **Always** keep your finger off the trigger until ready to shoot.
3. **Always** keep the gun unloaded until ready to use.

### Communications

Each range should have reliable communication with the appropriate staff overseeing the event or activity.

### Emergency Response Plans

A complete first-aid kit should be centrally located near the ranges. The location of the first-aid kit should be prominently marked. In the event of an accident, the established emergency protocols for the camp or activity should be followed.

### National Camping Standards

For standards related to range and target activities and day camp, short-term and long term camp operation and management procedures, refer to the current National Camp Accreditation Program Standards at [www.scouting.org/NCAP](http://www.scouting.org/NCAP).

### Standard Operating Procedures

All ranges must have their own written standard operating procedures (SOP) and have them posted at the range. See Appendix for a sample of an SOP.

### Equipment Inspections—Firearms and Archery

Prior to range operation, equipment must be inspected for safety and proper function. This inspection includes the firearm or apparatus being used as well as all protective equipment. During this inspection if any equipment is deemed unsafe or not sized appropriately for the participants, it must not be used. These inspections should be in advance of the activity or camp so if needed, corrective action can take place.

### SAFE checklist

All shooting and throwing sports activities are expected to follow the Scouting America SAFE checklist. Leaders and staff conducting shooting sports activities must conduct this checklist prior to the event or activity. For a model SAFE checklist for range and target activities see the SAFE checklist at the beginning of this manual.

## CHAPTER 7: ADDITIONAL CONSIDERATIONS

### General

**Lead protection.** Lead is a soft, dense metal that is an integral part of most bullets. Lead is toxic to humans in relatively small concentrations, with the most susceptible organs being the eyes, central nervous system, and gastrointestinal tract. Handling ammunition, setting up a range for shooting, counting out rounds for firing, loading and unloading a firearm, discharging a firearm, and cleaning a firearm can all leave lead residues on the skin. Two easy precautions can minimize the risk of inhaling or ingesting lead residues. First, when handling ammunition or a recently discharged firearm, minimize contact of the hands with other parts of the body, particularly the eyes, mouth, and skin. When you are finished handling ammunition or firearms, immediately wash your hands with soap and cold water. It is strongly recommended that a handwashing station be next to all ranges and storage areas where ammunition or firearms may be handled or used. Food and drink should not be permitted on a range or in storage areas.

The use of lead can also be an environmental concern and may require some additional consideration for a local council or the landowner. Care needs to be taken to contain the impact of the range on the environment.

Other environmental impacts: The discharge of a firearm can cause a loud report. This noise can also become an environmental concern when the range is close to neighbors or other land owners. Care must be taken in the selection of range locations keeping in mind the noise that could be caused during range and target activities.

**Cleaning solvents.** Solvents used for cleaning firearms typically contain petroleum distillates, ammonia, caustics, and other potentially hazardous chemicals. Hazards may include skin damage, lightheadedness caused by vapors, and risk of fire. In addition, once the solvent has done its job of cleaning a firearm, it not only contains the original chemicals, but now contains the residues from the firearm, which may include lead, copper, gunpowder, and burned plastic. As with lead, contact with the eyes, mouth, and skin should be discouraged while handling firearm cleaning solvents. Use of appropriate gloves and eye protection are strongly recommended when using any cleaning materials and solvents. Food and drink should not be allowed in areas where cleaning takes place. A hand washing station with soap and cold water should be available near the firearm maintenance/cleaning area.

**Considerations for people with special needs and disabilities.** Another consideration concerns participants who may have physical, intellectual, cognitive and/or developmental challenges. Every effort should be made to serve all youth and adults in Scouting. This may require modification of facilities, equipment, content delivery or processes. Safety is the number one concern. The question may need to be asked to how accommodations can be made so that any individual can shoot safely. Considerations to influence the course of action may include: What challenges are afforded by the special need or disability? Does the participant have someone helping them? Can you communicate effectively with the participant and helper? Ask the participant, parent, and/or unit leader what is the best way to accommodate the participant (never assume disability is synonymous with inability). It may be necessary to temporarily close the range to other participants so you can work one on one on the range with a participant with the special need. Consideration must also be given to the provisions of the Americans With Disabilities Act.

For information about adaptive shooting with range and target activities, visit the inclusion toolbox <https://ablescouts.org/toolbox/>



**SECTION IV**  
**TRAINING**



## CHAPTER 8: TRAINING COURSES

In Scouting events and activities, our primary consideration is the safety of youth and adult members. To achieve that goal, Scouting America, in consultation with other organizations, has created specific guidelines for range and target activities. These organizations also provide training and instructor certification by discipline-specific subject matter experts to prepare those individuals who will serve in a leadership or supervisory role in the various shooting sports activities.

In general, for all certifying organizations, the instructor candidate must meet specific eligibility requirements, satisfactorily complete the instructor training curriculum, understand and agree to the responsibilities of a certified instructor, and maintain active certification status.

Listed here are the shooting sports training certifications recognized by Scouting America.

### Scouting America Training

#### **Range SAFETY Online Training for Units**

At a minimum, all Scouts BSA troops, Venturing crews, and Sea Scout ships who provide unit-level sponsored/planned range and target activities must have at least one registered unit leader 21+ years of age take the Range Activity SAFETY online training at my.Scouting. This individual must be present at the range during the activity.

#### **Scouting America National Camping School**

Annually, seven-day National Camping Schools are conducted. The purpose of the National Camping School is to prepare Scouters who will be serving in management or supervisory roles in a council camp. Those who successfully complete the range activities section of the National Camping School, will be given a certificate of training as a Range Activities Director, which is valid for five camping seasons.

Participation must be approved by a local Scout executive, and enrollment is administered through the local council. For more information about National Camping School visit <https://www.scouting.org/outdoor-programs/national-camping-school/>

It is also expected that the Scouting America range and target activities will serve the council as a resource year-round and be an active member of the council's range and target activities committee.

### **Rangemaster Training**

Operation of BB, archery, and slingshot ranges for activities and events, including day camp, long-term camp, and short-term camping programs require qualified, trained Rangemasters.

BB/slingshot rangemaster and archery rangemaster training (2 separate courses) are administered by the council's range and target activities committee and conducted by a National Camping School certified range activities director or a council approved currently certified National Rifle Association rifle instructor for the BB/slingshot rangemaster and a USA Archery instructor certification for archery rangemaster. In either case the instructor must be familiar with the Scouting America program for which they are instructing (ex. NRA rifle instructor must be familiar with Cub Scout range and target activities if instructing BB range course for Cub Scout BB rangemaster.)

These BB/Slingshot rangemaster and Archery Rangemaster certifications are valid for two years from the date of the training.

A currently certified NRA rifle instructor is qualified to serve as a BB/slingshot rangemaster only if that person is familiar with the program policies and delivery of the Scouting America program they will oversee. A currently certified USA Archery Level 1 instructor or higher may serve as the Archery Rangemaster for archery activities.

### **National Rifle Association Training**

#### **NRA Certified Rifle Instructor**

A NRA Certified Rifle Instructor is required to provide instruction for Scouting America rifle shooting activities involving Scouts BSA, Venturers, and Sea Scouts.

The NRA rifle instructor may teach the Scouting America 30-Minute Rifle Briefing, the NRA FIRST Steps Rifle Orientation, Scouting America Rangemaster training, the Rifle Shooting merit badge using the Rifle Shooting Merit Badge Teaching Guide, and the eight-hour NRA Basic Rifle Course.

A currently certified NRA rifle instructor is qualified to serve as a BB Rangemaster for BB shooting and sling shot shooting activities provided the individual is familiar with the programs of Scouting America they will oversee.

### ***NRA Certified Shotgun Instructor***

An NRA certified shotgun instructor is required to provide instruction for Scouting America shotgun shooting activities involving Scouts BSA, Venturers, and Sea Scouts.

The NRA shotgun instructor may teach the Scouting America 30-Minute Shotgun Briefing, the NRA FIRST Steps Shotgun Orientation, the Shotgun Shooting merit badge using the Shotgun Shooting Merit Badge Teaching Guide, and the eight-hour NRA Basic Shotgun Course.

### ***NRA Certified Pistol Instructor***

An NRA certified pistol instructor is required to provide supervision for Scouting America pistol shooting activities involving Scouts BSA, Venturers and Sea Scouts.

The NRA pistol instructor may teach the Scouting America 30-Minute Pistol Briefing, the NRA FIRST Steps Pistol Orientation involving older Scouts BSA youth, Venturing and Sea Scouts. Older Scouts BSA members must be 13 years of age and have completed eighth grade or be 14 years of age.

### ***NRA Co-Op Muzzleloading Rifle Certified Instructor***

An NRA certified Co-Op muzzleloading rifle OR an NRA/NMLRA certified muzzleloading instructor is required to provide supervision for muzzleloading rifle shooting activities involving Scouts BSA, Venturers, and Sea Scouts.

### ***NRA/National MuzzleLoading Rifle Association Certified Muzzleloading Rifle Instructor***

The NRA certified co-op muzzleloading rifle or full NRA/NMLRA muzzleloading instructor is required to provide supervision for Scouting America muzzleloading rifle shooting activities involving Scouts BSA, Venturers, and Sea Scouts.

The NRA Co-Op muzzleloading rifle instructor or the NRA/NMLRA muzzleloading instructor may teach the NRA Basic Co-Op Muzzleloading Rifle Shooting Course and the muzzleloading option of the Rifle Shooting merit badge.

The NRA co-op muzzleloading rifle instructor may teach the NRA Basic Co-op Muzzleloading Rifle Shooting Course, and the Muzzleloading option of the Rifle Shooting merit badge.

### ***NRA/National MuzzleLoading Rifle Association Certified Instructor***

An NRA/NMLRA certified muzzleloading instructor is required to provide supervision for Scouting America muzzleloading shotgun shooting activities involving Scouts BSA, Venturers, and Sea Scouts.

The NRA/NMLRA muzzleloading instructor may teach the NRA Basic Muzzleloading Shooting Course and the muzzleloading option of the Shotgun Shooting merit badge.

The NRA/NMLRA muzzleloading instructor may teach the NRA Basic Muzzleloading Shooting Course to Venturers and Sea Scouts.

### ***NRA Range Safety Officer***

An NRA Range Safety Officer is required to provide live firing range supervision for all shooting activities involving Scouts BSA, Venturers, and Sea Scouts. No other certification is accepted.

The NRA Range Safety Officer is responsible for the range management.

### ***NRA Chief Range Safety Officer***

An NRA chief Range Safety Officer or an NRA training counselor is qualified to teach the NRA basic Range Safety Officer course. The Chief Range Safety Officer may also assist Scouting activities in the role of the Range Safety Officer.

### ***NRA Training Counselor***

Qualified, experienced, certified instructors may apply for appointment as a training counselor to recruit and train new instructors to teach basic firearms training courses. For information about becoming a NRA training counselor visit [www.nrainstructors.org](http://www.nrainstructors.org).

## **Archery Training**

### ***USA Archery Level 1 Instructor***

The USA Archery Level 1 Instructor Certification course is administered by USA Archery, the national governing body for the Sport of Archery in the U.S., USA Archery, the National Field Archery Association and the Archery Shooters Association jointly recognize all certification levels.

Candidates for the USA Archery Level 1 instructor certification are primarily camp archery staff and those working with entry-level students. The USA Level 1 Archery Instructor Certification Course provides

graduates the necessary tools to maintain a high level of safety both on and off the archery range. The Level 1 Instructor will learn about range safety, range setup, the steps of shooting, equipment and repair, programs and lesson plans and is well prepared to teach beginner archery programs to people of all ages and abilities in a variety of disciplines.

USA Archery Level 1 Archery Instructors may teach the Basic Archery course and the Archery merit badge.

In addition, the certified instructor may serve as a Rangemaster for a Cub Scout archery activity.

### ***USA Archery Level 2 Instructor***

The Level 2 Archery Instructor Certification Course includes the USA Level 1 Archery Instructor Certification Course and provides students with an introduction to the National Training System (NTS) Steps of Shooting for recurve and compound, equipment and accessory setup, athlete development and events. Candidates for the Level 2 instructor certification are instructors age 18 and older and Level 2 instructors may also take an online course to become a USA Archery Instructor Trainer so that they may train USA Archery Level 1 and USA Archery Level 2 instructors.







**SECTION V**  
**RANGE AND TARGET ACTIVITIES FOR CUB SCOUTS**



## CHAPTER 9: INTRODUCTION

Archery, BB gun, and sling shot shooting for all ranks of Cub Scouts are restricted to District or Council organized day camps, the Cub Scout range and target adventures long term camp, short term camp or to council activities held on or off an accredited camp property where the district or council provides currently trained Scouting America range and target activities Rangemasters and all standards for Scouting America range and target activities are enforced.

Archery, BB gun, and sling shot shooting in Cub Scouting are prohibited at the pack level or den level. A multi-pack or multi-den event is not to be considered a district or council activity.

Range and target activities related adventures for Cub Scouts may be earned only at the camps and activities listed above.

These programs are designed to emphasize safety and marksmanship development under the direction of trained Rangemasters using nationally approved instructional methods.

This section is for National Camping School certified Range Activities Directors with archery and/or NRA rifle certification or for NRA instructors or USA Archery instructors who will teach the skills of archery, BB gun or sling shot shooting to Lions (archery and sling shot only) and Tigers with their adult partners, Wolf Cub Scouts, Bear Cub Scouts, Webelos Scouts and Arrow of Light Scouts. There is potential danger to the untrained participant and others. "Safety through skill" is the watch phrase.

Special facilities and supervision are required for range and target activities. Camp properties of local councils become the center for most of these activities.

Shooting sports training provides fun and adventure for youth. Archery, BB gun and sling shot shooting teach skills, discipline, self-reliance, sportsmanship, and conservation, all of which are elements of good character valued by Scouting America.

Adventure beckons when Lions and Tigers with their adult partners, Wolf Cub Scouts, Bear Cub Scouts, Webelos Scouts and Arrow of Light Scouts have mastered the skills. Mastery of these skills will help a youth feel confident in their abilities.

The council's camping property usually is an ideal location for range and target activities areas. Here, safely designed areas may be established for the Cub Scout range and target activities program. Under qualified leadership, Lions and Tigers with their adult partners, Wolf Cub Scouts, Bear Cub Scouts, Webelos Scouts, Arrow of Light Scouts and parents may be given the opportunity to participate in these activities.

Other community resources such as the local chapter of the National Rifle Association, archery clubs, and sports groups will often provide facilities and resources.

The skills needed to master shooting sports adds color and variety to the Cub Scout program. These activities can become a natural part of our camp setting.

### Leadership

In camp, leadership for range and target activities needs special attention by the camp director and their program director. Staff members must be certified per Scouting America qualifications for these activities and must be at least 18 years old with mature judgment and the ability to teach. In Cub Scout day camp, long-term camp, or short-term camps, the staff should be members of the program staff. Volunteer experts who come to camp for shorter periods may supplement their work.

All ranges in the Cub Scout program must be supervised by a qualified Rangemaster who is at least 18 years old and who meets the minimum state requirements. See specific qualifications and training requirements for archery Rangemaster and for BB gun and slingshot Rangemasters starting on page 165.

## CUB SCOUT RANGE AND TARGET ACTIVITIES

### BB Gun Elective Adventures – Cub Scouts

BB gun programs are an exciting, worthwhile activity for Scouts, and it is one of the most popular program activities held at camps. The BB gun Cub Scout elective adventures provide fun and adventure, yet also teach skills, discipline, self-reliance, and sportsmanship. We will teach Tiger Cubs with their adult partners, Wolf Cub Scouts, Bear Cub Scouts, Webelos Scouts, and Arrow of Light Scouts how to use BB guns safely. (*Lion Cubs are NOT allowed to use BB guns.*)

Intelligent, supervised use of BB guns is consistent with the principle of “safety through skill.”

Approval has been given for BB gun (defined as a smoothbore spring-piston or air rifle propelling shot known as “BBs”) safety and marksmanship programs in district or council Cub Scout programs. **The barrel velocity must be 350 feet per second maximum.** All ranks of Cub Scouts are not permitted to use any type of handgun or any other type of firearm.

**The use of pellet rifles is restricted to Webelos Scouts and Arrow of Light Scouts in a long-term camp setting and qualifies when in compliance with the following:**

- The pellet rifle range meets or exceeds Scouting America and NRA recommendations and appropriate Outdoor Programs/Properties design standards. The range is on nationally authorized camp property’s range(s) or at a commercial firearm range. A commercial firearm range is a supervised facility that offers a controlled environment for safe firearm practice. It will provide shooting lanes, targets, and may offer equipment rentals and training in safe firearm handling and marksmanship. Standard operating procedures are required for each firearm type used on-site. Scouting’s range and target activities must follow all of Scouting’s range and target activities policies or range standard operating procedures that are equivalently stringent, including no variation from Scouting’s limitations on firearms used. These ranges may be operated by a licensed business, a government entity or non-profit.
- All pellet rifles are in good repair are provided. All pellet rifles used in Scouting’s range and target activities have a trigger pull in excess of 2.5 pounds and are tested with a 2.5-pound weight or scale at least once a week while in use. If any trigger mechanism fails, the pellet rifle is immediately removed from service. Documentation of the tests is maintained.
- All pellet rifles (CO2, pump, break barrel, etc.) are limited to single-shot designated for target shooting, velocity of 500 to 540 feet per second, and energy levels not to exceed 7.5 joules.

- Safe, separate and locked storage (can be the same building) is provided for pellet rifles, pellets, and CO2 cylinders and bulk tanks.
- Pellet rifle propellant is limited to CO2 cylinders or air compressor/scuba tanks. Refilling is conducted by qualified adults with appropriate controls. If scuba tanks are used, each tank must be visually inspected annually and hydrostatically tested every five years by a qualified technician.

### A Brief History of BB Guns

In ancient history, blowguns began to appear in many different parts of the world. Although crude, these primitive devices were very accurate. They were made from bamboo or other hollowed-out woods.

A blowgun is a tube into which a hunter blows to shoot a projectile out the other end. This idea was transferred into gun form somewhere in the 1500s. The bellows gun, invented around 1580, is the earliest known air-powered gun.

A few decades later, the first pneumatic (pump-up) air gun was created in France for King Henry IV. The nobility usually owned these early guns, since they were too expensive for commoners.

In the late 1700s, some units of the Austrian army were equipped with air rifles.

In America, records show that in the 1800s, Lewis and Clark had an air gun for hunting and impressing the native Americans. The native Americans called it “the smokeless thunder stick.”

In 1885, in the United States, the Markham Air Rifle Company became one of the first companies to sell BB guns. These pneumatic rifles eliminated bullets and used a small pellet the size of a ball bearing, soon to be called a “BB.”

A few years later, a company that sold steel windmills decided to also sell BB rifles. By 1895, this company had stopped producing windmills and made air rifles full-time and changed the company name to Daisy.

Daisy’s guns were mostly made of steel, which improved the gun’s strength and design. The Daisy air rifle became popular very quickly, and within five years Daisy had sold 250,000 BB guns. Soon, Daisy bought out all of its competition.

Daisy also promoted to youth by making special BB guns that related with popular historical characters like Davy Crockett.

In 1984, the Olympic Games featured air guns for the first time.

Today, BB guns are still being produced in both rifle and pistol forms and are very popular among all age groups.

### Leadership

BB gun Cub Scout elective adventures must be conducted by trained, qualified, on-site rangemasters who direct the operation of the range program and BB gun shooting instruction. The ratio of BB gun rangemasters to shooters is 1-to-8 on the firing line. To qualify as a BB gun rangemaster, the rangemaster must be at least 18 years old and be trained by a National Camping School–trained range activities director or a National Rifle Association rifle instructor.

The BB gun rangemaster also must be registered with Scouting America.

The local council issues a Training Course Pocket Certificate, No. 33767, and keeps a record of those who have been certified. BB Gun Rangemaster, course code CS 32. Certification must be renewed every two years.

### Training BB Gun Rangemasters

This training is conducted by a National Camping School Range Activities Director. This training should be conducted on a BB gun range. Include a practical exercise on how to set up a BB gun range, referencing the range design guideline posted on [scouting.org/outdoorprograms](http://scouting.org/outdoorprograms), and have the participants walk through the process of running the range.

The outline to train BB Rangemasters can be found in the appendix.

### Training Cub Scouts

The objective is to teach Cub Scouts how to use a BB gun safely, to teach basic BB gun shooting skills, and to have fun. They should have the opportunity to fire a BB gun during the first orientation period. This activity is not intended necessarily to produce expert marksmen.

The instructor must always be mindful of their responsibility to make safety thoroughly understood before, during, and after instruction and practice. At the same time they must have warmth, patience, and understanding for the Scout who finds the skill difficult to learn.

To download lesson plans to instruct each rank of Cub Scouting BB gun elective adventures, visit [www.scouting.org/outdoorprograms](http://www.scouting.org/outdoorprograms).

### Teaching Tips

The coach-pupil method is effective for all types of skill training and is particularly effective in shooting sports. To put this method into practice:

1. Put the BB gun in the Cub Scout's hand as soon as possible so they can understand the BB gun while the basics are explained.
2. Group participants into pairs (Scout and parent/guardian would be ideal).
3. The instructor demonstrates the activity or action to be followed before the whole group. When demonstrating techniques, be sure to do them correctly. The instructor then circulates among the pairs giving a word of advice or assistance, recognizing good work, correcting errors, and determining how well the participants understood the method.
4. The Scout practices while the parent coaches. Let Scouts shoot the first round. At a predetermined signal, reverse the roles. Progressively, participants are learning by observing, by doing, and by coaching.
5. Use a positive approach. Use praise sincerely. Before making a correction, question the fault to find the cause. Show the youth what they are doing wrong.
6. Avoid long discussions on the parts of the equipment used. Teach just enough so participants will know how to safely use the equipment.
7. Allow each Scout to feel the satisfaction of hitting a target as quickly as possible.
8. Scouts do not have to load one BB at a time and shoot before loading another BB. They can load at one time all the BBs they are given.
9. In the following outline, "Cub Scout BB Gun Shooting Training," the time needed to conduct each section is not indicated because it will vary depending on the number of Cub Scouts participating.

### Cub Scout BB Training—Youth

#### Section I

A. Safety Guidelines, page 48

B. Equipment, page 54

1. Review diagram of Spring-Piston Gun (*Ensure to cover stock, butt, trigger, trigger guard, forearm, muzzle, rear sight, and safety.*)
2. Targets (Available online at [www.scouting.org/outdoorprograms](http://www.scouting.org/outdoorprograms))
3. Maintenance
  - The BB Gun must be unloaded when stored.
  - The safety mechanism must be engaged.
  - The BB Gun should be protected from scratches or scraps from other guns.
  - The BB Gun must be locked or otherwise secured in a safe, dry location, separate from ammunition.

## Section II

- A. BB Gun Shooting Basics, page 49
  - 1. Eye Dominance, page 49
  - 2. Shooting Shoulder, page 49
  - 3. Breathing, page 49
  - 4. Sight Alignment, page 50
  - 5. Trigger Squeeze, page 50
  - 6. Follow-Through, page 50
- B. BB Gun Shooting Practice Fun, page 52

## Section III (optional activities)

- A. Shooting Positions, page 50
  - 1. Free-Arm Standing Position, page 50
  - 2. Bench Rest Position, page 51
  - 3. Prone Position, page 51
  - 4. Sitting Position, page 51
- B. BB Gun Shooting Games and Activities, page 52
- C. Cub Scout BB Gun Elective Adventures  
(Visit [www.scouting.org/outdoorprograms](http://www.scouting.org/outdoorprograms).)

### *Tiger Cubs and BB Gun Shooting*

Tiger Cubs and their adult partners may participate in BB gun shooting activities. The adult partners must be included in all shooting activities. Each Tiger Cub must be paired with their adult partner before being allowed to shoot. In many cases, when Tiger Cubs and their adult partners participate in BB gun shooting, it will be at a day camp.

Keep in mind that youth of this age have very short attention spans (20 to 30 minutes maximum), and tire easily. They probably have little previous experience working as a group and may require more time to understand how the range operates. Tiger Cubs have a wide range of ability and experience levels, so be ready for anything!

### **Safety Guidelines**

When training youth to shoot, be sure to have proper equipment, secure and safe ranges, and clear safety instruction.

Gun safety is a simple but continuous process. Youth must first learn about safe gun handling. Safe handling skills are developed through practice. The most important safety element is attitude. All the safety knowledge and skills are of little value unless they are used. Being safe means consciously keeping a BB Gun under control.

Before handling any gun, a Scout must always get permission from their parent or guardian. If this is their first BB Gun shooting experience, they should sit down with an adult and discuss under what circumstances the gun can be handled. They must understand that the BB gun is not a toy.

Before using a gun:

- Always get permission from your parent or guardian.
- Always have an adult present when you use a gun.
- Know how the gun works and how to use it.
- Always be sure of your target and what is beyond the target.
- Always wear eye protection.
- Never reuse BBs.

These basic rules apply to handling a BB Gun under any circumstances:

1. **Always keep the gun pointed in a safe direction.** This is the primary rule of gun safety. “Safe direction” means the gun is pointed so that even if it were to go off, it would not cause injury or damage. The key to this rule is to control where the muzzle or front end of the barrel is pointed at all times. Common sense dictates the safest direction depending on circumstances.
2. **Always keep your finger off the trigger until you are ready to shoot.** When holding a gun, rest your finger along the side of the gun or the trigger guard. Until you are actually ready to fire, do not touch the trigger.
3. **Always keep the gun unloaded until ready to use.** When you pick up a gun, carefully point it in a safe direction. Engage the safety, if possible. Then, while keeping your finger off the trigger, open the action and look inside the chamber(s) to make sure it is clear of ammunition. If the gun has a magazine, remove it before opening the action and make sure it is empty. If you do not know how to open the action or inspect the chamber(s), leave the gun alone and get help from someone who does.
4. **Know how to use a gun safely.** Before handling a gun, learn how it operates. Know its basic parts and how to safely open and close the action. Know how to remove ammunition from the gun or magazine.
5. **Be sure the gun is safe to operate.** Just like other tools, guns need regular maintenance to remain in good working order. Regular cleaning and proper storage are part of the gun’s general upkeep. If there is any question about a gun’s ability to function, then do not use it. Get someone to fix it!
6. **Use only the correct ammunition for the gun.** Only the BB designed for a particular BB gun can be fired safely in that gun. Do not shoot the gun without loading the proper ammunition.
7. **Wear eye protection.** Always wear eye protection. Shooters and instructors should wear approved safety goggles at all BB gun ranges. BBs may ricochet.



8. **Never use alcohol or drugs before or when shooting.** Alcohol or any other substance likely to impair normal mental or physical function must not be used before or while handling or shooting guns. This may include prescription medications.
9. **Most guns have a mechanism called a safety** that helps prevent the gun from accidentally firing. However, a safety is a mechanical device, which can and will fail. Shooters must be trained that the safety mechanism is not a sure, safe way to prevent a gun from firing. Many accidents have occurred because shooters have relied on the safety mechanism to work.
10. **Although not mandatory for BB gun shooting, ear protection may also be worn.** Shots fired from guns are loud, and the noise could damage the hearing of some shooters.
11. **Know your target and what is beyond the target.** Be absolutely sure to identify the target beyond any doubt. Equally important, be aware of the area beyond the target. Never fire in a direction where there are people or where any other potential for mishap might exist. Think first. Shoot second.
12. **Store guns so they are not accessible to any unauthorized person.** Deciding where and how to store guns and ammunition depends on several factors and include security and accessibility. Safe and secure storage means untrained individuals (especially children) are denied access to guns and ammunition.

### *What Causes Gun Accidents?*

Most air gun accidents are caused by ignorance and/or carelessness.

- Ignorance: A lack of knowledge
- Carelessness: A failure to use knowledge

### *Safety Reminders*

What should a Cub Scout do if they find a gun in another place?

- STOP!
- DON'T TOUCH!
- LEAVE THE AREA!
- TELL AN ADULT!

### *Sun Safety on the Shooting Range*

The American Academy of Dermatology advises the following protection tips against damaging rays:

- Limit exposure to sun between 10 a.m. and 4 p.m. when the sun's rays are the strongest.
- Generously apply sunscreen with a sun protection factor (SPF) of at least 15 and reapply it every two hours when outdoors, even on cloudy days.
- Wear protective, tightly woven clothing, such as a long-sleeved shirt and pants.
- Wear a hat with a wide, 4-inch brim and sunglasses with UV protective lenses.
- Stay in the shade whenever possible.
- Avoid reflective surfaces, which can reflect up to 85% of the sun's damaging rays.

### **BB Gun Shooting Basics**

#### *Eye Dominance*

Before shooting a BB gun, the participants should determine which eye is dominant. Just as people are either right- or left-handed, one eye is more dominant than the other. Discovering which eye a shooter favors is important because it could determine on which side the gun is held.

To find which eye is dominant, have participants extend both arms in front of them and form a small hole with their thumbs and index fingers. Instruct them to look at a distant object through the opening and then pull their hands back to their face. The eye that is in line with the object is dominant.

Assign youth, leaders, and parents in pairs to assist each other, then have them check with the rangemaster.

#### *Shooting Shoulder*

It is recommended that a shooter use the shoulder that is on the same side of the body as the dominant eye. If the right eye is dominant, place the firearm against the right shoulder. If the left eye is dominant, use the left shoulder.

#### *Breathing*

When shooting, stop breathing before firing a shot. Breathing causes the body to move and makes it difficult to maintain a steady sight picture. Before firing, relax and get comfortable. Then exhale and stop breathing. This technique will help shooters aim by reducing the body and rifle movement in relation to the target. Do not stop breathing for longer than eight to 10 seconds while aiming at the target. If you are not able to shoot within that time, stop, take a breath or two, and repeat the process.

## Sighting Chart

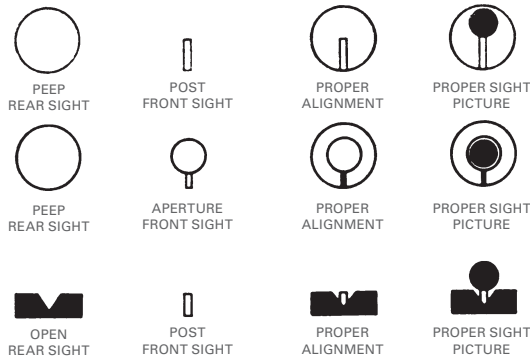

### Sight Alignment

The shooter must learn proper sight alignment. This is the relationship of the front and rear sights to the eye. The shooter's dominant eye must be lined up with the front and rear sights, and the sights must be positioned so the front sight device is aligned properly with the rear sight.

Proper sight alignment is a key to accurate shooting. Any misalignment of the front sight with the rear sight introduces an angular error that is multiplied with distance.

A correct sight picture is obtained by achieving the proper alignment and then putting the aligned sights into their proper relationship with the target.

Focus should be on the front sight.

### Trigger Squeeze

Trigger squeeze is the term used to explain how pressure is applied to the trigger. Some other terms commonly used are trigger pull, trigger control, trigger press, and trigger movement. While all these terms are correct, the preferred term is trigger squeeze because it accurately describes the smooth application of pressure required.

When ready to begin squeezing the trigger, the index finger should be on the trigger so the trigger is about halfway between the tip of the finger and the first joint.

The trigger must be squeezed straight back in a smooth, continuous manner without disturbing the sight alignment. Once trigger squeeze has begun, keep squeezing smoothly and continuously—do not speed up or slow down or apply pressure in a start-and-stop manner. Use the same type of pressure that would be used to squeeze a drop of liquid from a medicine dropper—a gradual, steady application of pressure until the drop finally falls. Just as it would be impossible to predict the instant the drop of liquid will fall, it should be impossible to predict the precise instant the gun will fire. Each shot should come as a surprise.

For best results, the trigger squeeze should be done as the shooter holds steady on the correct sight picture.

### Follow-Through

The shooter must also master proper follow-through. Follow-through means to continue to do everything that was being done at the time the shot was fired. In other words, keep aiming until the BB hits the target.

The idea is to prevent any unnecessary movement before the projectile leaves the barrel. Because an air gun takes longer to send a projectile out of the barrel, proper follow-through is particularly important.

### Shooting Positions (All positions are described for right-handed shooters. Reverse for left-handed shooters.)

Proper body position is essential to achieve a good shooting score. When learning any shooting position, these basic steps must be followed:

1. Study the position.
2. Practice the position without a gun. (Learn to put the feet, legs, body, head, and arms in the correct position without holding a gun.)
3. Practice the position with a gun.
4. Align the position properly with the target. Adjust the position so the gun points naturally at the target.
5. Shoot from the position.

### Free-Arm Standing Position

#### Body position:

- **Feet.** Stand with feet shoulder width apart and body weight evenly distributed.
- **Body and head.** Keep the body and head comfortably erect.
- **Face.** Place your cheek against the stock so you are looking down the barrel.
- **Knees.** Keep the knees straight but not locked.
- **Left arm.** Rest the left arm against the rib cage to support the rifle.
- **Left hand.** Place the left hand under the fore-end of the rifle to support the weight of the rifle.
- **Right hand.** Grasp the rifle grip with the right hand.
- **Right shoulder.** Position the rifle butt against the right shoulder so the sights are at eye level.



**FREE-ARM  
STANDING POSITION**

### ***Bench Rest Position***

#### **Body position:**

- **Body & Feet.** Seated at the bench. Body leaning forward slightly, and feet flat on the floor.
- **Head.** Keep the head comfortably erect.
- **Face.** Place your cheek against the stock so you are looking down the barrel.
- **Left arm.** Rest the left elbow against the bench to support the rifle.
- **Left hand.** Place the left hand under the fore-end of the rifle to support the weight of the rifle.
- **Right hand.** Grasp the rifle grip with the right hand.
- **Right shoulder.** Position the rifle butt against the right shoulder so the sights are at eye level.

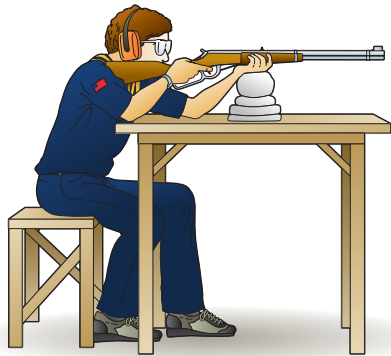

**BENCHREST POSITION**

### ***Prone Position***

#### **Body position:**

- **Body.** Lie on the ground, facing the target and angles slightly left.
- **Right knee.** Slightly bend the right knee.
- **Right leg.** Draw the right leg up, keeping it parallel to the back, and place the right foot on the ground.
- **Face.** Place your cheek against the stock so you are looking down the barrel.
- **Left elbow.** Extend the left elbow forward.
- **Left hand.** Hold the fore-end of the rifle with the left hand.
- **Right hand.** Grasp the rifle grip with the right hand.
- **Right shoulder.** Position the rifle butt against the right shoulder so the sights are at eye level.



**PRONE POSITION**

### ***Sitting Position***

#### **Body position:**

- **Body.** Sit cross-legged at a 45-degree angle to the line of fire.
- **Feet.** With the sides of the feet flat on the ground, rest the calves on the upper sides of the feet.
- **Elbows.** Rest both elbows on the legs just in front of the knees.
- **Face.** Place your cheek against the stock so you are looking down the barrel.
- **Left hand.** Hold the fore-end of the rifle with the left hand.
- **Right hand.** Grasp the rifle grip with the right hand.
- **Right shoulder.** Position the rifle butt against the right shoulder so the sights are at eye level.



**SITTING POSITION**

### **Basic Shooting Activity**

This shooting activity covers many of the basic fundamentals needed in shooting a BB gun. Pair Scouts and adults as shooters and coaches.

1. Greet the participants.
2. Bring the participants onto the range.
3. Show the gun and say “This is a BB gun.”
4. Point to the barrel and say, “This is the barrel.”
5. Point to the muzzle and say, “This is the muzzle. It is the end the BB shoots out.”

**Always keep the gun pointed in a safe direction.**

6. Point to the action and say, “This is the action. It has the trigger—the part you squeeze to shoot.”

**Always keep your finger off the trigger until you are ready to shoot.**

7. Say, “The action also has the chamber where you put the BB to load the gun.”

**Always keep the gun unloaded until ready to use.**

8. Point to the stock and say, “This is the stock.” Then demonstrate how to hold the gun: Put the butt of the stock against your shoulder, hold the grip with the hand of the same arm, keeping your finger off the trigger and pointed in the

- same safe direction as the gun. Hold the forearm with your other hand.
9. Say, “You will use the free-arm standing position like this.” Demonstrate the position that is recommended for your range.
  10. Have everyone on the range put on eye protection, either safety glasses or goggles.
  11. Say, “Shooters, please move forward at my command.” Then give the command, “ON THE FIRING LINE.”
  12. Assume the shooting position.
  13. Have shooters pick up their guns, keeping them pointed in a safe direction downrange.
  14. Have shooters again assume the shooting position, this time with the gun, and look through the sights. Explain how the sights are used.
  15. Once all shooters know how to assume the shooting position and how to properly hold the gun, explain and demonstrate how to charge the gun.
  16. Have shooters load BBs into the chamber. (Explain further.) Close and ready the gun.
  17. Return to your shooting position. Note that everyone can make ready and load the gun.
  18. Give the command “READY ON THE FIRING LINE.”
  19. When shooters are in the ready position, give the command “COMMENCE FIRING.” Shoot all your five shots.
  20. Watch for safety and help as needed.
  21. Give the command “CEASE FIRE.” Everyone is to stop shooting.
  22. Give the command “CLEAR ALL GUNS.” Have everyone clear their gun.
  23. Explain and demonstrate how to make a gun safe. Explain how to ground the gun for position and range.

### **BB Gun Shooting Games and Activities**

A variety of games or activities can be done with BB gun shooting skills. Different ranges could be set up to play a particular game or courses could be set up where participants go from station to station. BB gun shooting games and alternate activities work well, especially when youth are in camp for more than one day or if a council sponsors a special BB gun shooting camp for Cub Scouts. Shooting games are designed to improve shooting skills. Remember—safety is a must.

The following games and activities are appropriate for Tiger Cubs with their adult partners, Wolf Cub Scouts, Bear Cub Scouts, Webelos Scouts and Arrow of Light Scouts.

### **Fun Target Activities**

- Make 8.5-by-11-inch targets with several squares on each. Put a number in each square. Shooters can see the squares but not the numbers in them. After firing at the page, the shooter adds up the numbers

from the squares that their BBs hit. The highest score is the winner.

- Place dots on a target, then shoot at the back side of the target. Count the score from the dotted side.
- Suspend table tennis balls in a box to use as targets.
- Create a target by taping round candy to the back of a box. When the target is hit by the BB the candy shatters.
- Set up balloons as targets.
- Set up crackers as targets. Have participants shoot at the narrow edges of the crackers.

### ***Tic Tac Toe***

Place three rows of three balloons on a target mat. Divide the group into two lines and have them stand in a single file 20 feet from the target. At the signal to shoot, each shooter will shoot one BB and step back. The second and each succeeding person will shoot one at a time. The first team to break three balloons in any line is the winning team.

### ***BB Gun Shooting Practice Fun***

A practice station is a simple, basic BB gun shooting range, but is very fun for Cub Scouts. Many Cubs have few opportunities to shoot guns, so having the opportunity at a council camp or event to practice is a great experience for them.

Discuss and emphasize the primary rules of proper gun handling. Point out that all guns are potentially dangerous.

Practice the following skills:

- Have participants always point the muzzle in a safe direction and to be sure of their target.
- Show how to handle a gun while standing and when walking.
- Demonstrate and practice various gun-handling situations—how to pass the gun to another person, how to cross a fence with it, how to store it in an automobile, and how to get in and out of a boat with it. Use real or artificial situations, but use the Scouts as demonstrators and require them to practice with others watching.
- Review sight pictures and sight alignment. Give reasons for sighting in a gun before shooting. Tell how little mistakes in sight alignment cause big misses on the target.
- Explain sight adjustment—move the rear sight in the direction you want the BB to go.
- Have relays, prone position without magazine, using sling or sandbag and paper targets.
- Explain the use of BB dishes.
- Demonstrate sitting, kneeling, and standing shooting positions.
- Shoot five rounds per Cub Scout using the standing position.



## Range Layout

A sample outdoor BB Gun range layout is posted online at <https://www.scouting.org/outdoor-programs/properties/resources/design-guidelines/>. Safety is a primary concern when operating a BB Gun range, and all safety rules must be followed.

If at all possible, the range should be laid out so shooting is done in a northerly direction so shooters are never facing the sun.

### *Shooting on a Safe Range*

A safe range must have three things:

1. A safe area.
2. A safe distance
3. A safe backstop

1. **Safe area.** Whether inside or outside, be sure the range is set up so no one can accidentally walk in front of the firing line. When indoors, make sure doors and side windows are locked. When outside, make sure to always shoot in a safe direction. In either case, never point the gun toward windows or where people might walk.
2. **Safe distance.** Maintain at least 15 feet between the shooter and the target.
3. **Safe backstop.** A backstop to trap BBs and hold the target can easily be made from a large cardboard box. Do not shoot at a hard surface that could cause a ricochet. If using a tarp as a backstop, it is important to verify that the tarp is made of a heavy canvas material and not a thin plastic canvas material. It is best to hang the material at a 45-degree angle. Bales of straw also work well.

Important! Arrange facilities so there is no possibility of non-participants inadvertently walking behind the targets while shooting is in progress! No one may stand directly in front of the target while shooting is in progress!

**Inflatable Ranges** Only commercially manufactured equipment is allowed to be used. (*A Scouting America certified BB Gun Rangemaster or individuals specified in NCAP standard SQ 407 must supervise the range.*)

If an inflatable range is utilized, appropriate side and rear boundaries must be in place. (Minimum 10 ft. on the side, 15 ft. behind the target zone and 15 feet behind the shooting line.) There must also be a distinct gated entrance to access the shooting line. (*Manufacturers guidelines must always be followed if they are more stringent, and you may only use manufacturers recommended equipment.*)

## Range Operation Rules

When operating the range, the safety rules must be remembered and constantly obeyed.

1. If the range is outdoors, fly a red range flag whenever the range is in use. The flag should be large enough and high enough on a flagpole to be seen from all approaches to the range.
2. Shooters reporting to the firing line will be issued a specific number of BBs and a BB dish that will be placed in plain sight at the firing point.
3. Shooters will be instructed that in case of a misfire the BB gun will be kept pointed at the target. The instructor will be called. If the malfunction is due to a broken part, the gun, after being cleared of BBs, will be removed from the firing line.
4. BB guns must be left with the action open or at half-cock, in the case of lever action spring-piston air guns, except when the shooter is in position on the firing line and has been given the command to load. (Half-cock position on a lever action spring-piston air gun is with the lever down, but without the spring compressed or cocked. To check to see if the gun is cocked, pull the lever forward; if there is no pressure on the lever, the spring is compressed and the gun is cocked.)
5. As soon as the command to cease firing is given, the BB guns must be opened and placed on the shooting mat with their muzzles pointing down-range, actions open or at half-cock, whether or not the shooter has completed firing all their shots. This rule must be enforced and obeyed absolutely.
6. In preparing to fire, the targets are first placed in position. The shooters then take their places on the firing line. While the first group is firing, the targets are prepared for the next group of shooters and they are told their firing point. When the first group has completed firing and all BB guns are unloaded and actions open or at half-cock, the fired targets are taken down and the new targets set up.
7. No one, shooter or instructor, is allowed in front of the firing line after the order has been given to load and before the order has been given to cease firing—actions open.
8. No one is allowed on the firing line except the shooters and their coaches or instructors.
9. Horseplay of any kind is forbidden on the range. Spectators and those who are waiting their turn to fire are not permitted to do anything that may distract the attention of the shooters from the business of shooting accurately and safely.
10. All BB guns not in use should be kept in racks with the actions open or at half-cock.

## Sample Range Rules Poster



### GENERAL SHOOTING RANGE RULES

1. This range may be opened only by a qualified Scouting America-certified range master.
2. All commands issued by the range master must be obeyed immediately.
3. Stay behind the firing line. Do not straddle the firing line.
4. Do not pick up a gun, bow, arrow, or slingshot unless told to by the range master.
5. Absolutely no running on the range.
6. No horseplay or unnecessary talking on the range.
7. If in doubt about the rules, ask your leader or range master for advice or help.

This poster can be found in the Appendix of this guide.

### Range Commands

When ready to start firing, the rangemaster commands: “ON THE FIRING LINE.”

Immediately, each shooter takes their assigned place at their firing point and prepares to fire, but does not load. The rangemaster checks the location of each shooter to ensure correct firing point and target number.

The rangemaster makes sure the range is clear, then asks: “IS THE LINE READY?”

If there is any shooter who is not ready or whose target is in bad order, that shooter immediately raises their arm and calls:

“NOT READY” and gives the number of their target.

The rangemaster will immediately call:

“THE LINE IS NOT READY.”

The rangemaster will investigate the difficulty and assist in correcting it. When the difficulty has been corrected, the rangemaster calls:

“IS THE LINE READY?”

If all is ready, the rangemaster then calls:

“THE LINE IS READY.”

(This means the line is ready on the right, ready on the left, and ready on the firing line.)

The rangemaster calls:

“LOAD.” Shooters load the BB gun chambers.

The rangemaster calls:

“READY ON THE FIRING LINE.”

The rangemaster commands:

“COMMENCE FIRING.”

After firing, the rangemaster commands:

“STOP FIRING — CLEAR ALL GUNS.” All BB

gun chambers and magazines are unloaded and shooters leave the firing line with the actions of their BB guns open.

Repeat the above steps for all succeeding shooters.

The rangemaster will immediately command “STOP FIRING” if any incident occurs that could result in possible injury to some living thing should firing continue.

“AS YOU WERE” means to disregard the command just given. “CARRY ON” means to proceed with whatever was being done before the interruption occurred.

### Equipment

#### Range Accessories

- Tarps to provide shade over the pads protecting the shooters and the guns
- BB dishes at each firing point
- Shooting mats at each firing point
- A desk with storage space for equipment for recording scores. It should be behind the ready line and near the bulletin board.
- Ample waste receptacles behind the firing line for fired targets and trash
- Sandbags or other rest equipment for each firing point
- Range flag and pole for use during range operation
- BB gun racks to store BB guns that are not in use

#### Air Guns

Air guns, traditionally regarded as guns for beginners, are now enjoyed by shooting enthusiasts at all skill levels. Some, such as the familiar BB gun, are excellent for beginners, while other types are designed for the seasoned competitor. Whether used for recreation or sport, for field use or as an inexpensive training tool, air rifles are an excellent way to enjoy shooting.

In recent years, air guns have undergone dramatic improvements, making them more reliable, durable, and accurate. Air guns can be fired safely by shooters of all ages and experience levels on a wider variety of ranges than any other type of firearm.

#### Spring Piston Guns

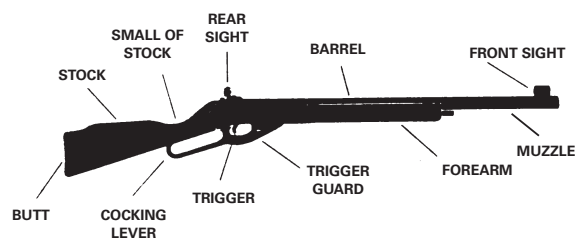

Spring-piston air guns use a manually operated lever, pivoting barrel, or other device to move a piston that in turn compresses a mainspring located in the frame or receiver portion of the gun.

When the piston is completely retracted, the mainspring is fully compressed. The piston will remain in this retracted position until the shooter releases it by pulling the trigger. The piston, under pressure from the compressed mainspring, moves rapidly forward when it is released, and compresses the air in front of it. The compressed air then forces the projectile out of the barrel.

In this type of air gun, the air that propels the projectile is not stored in a reservoir prior to firing; the air is compressed by the movement of the piston after the trigger is pulled.

### ***Pneumatic Guns***

Pneumatic air guns use the principle of stored compressed air or gas and can be divided into two categories: single-stroke/multi-pump guns and compressed CO<sub>2</sub>/air guns.

### ***Air Gun Ammunition***

There are five basic types of air gun ammunition: BBs, pellets, lead balls, darts, and bolts.

Keep BB Gun shooting equipment in good condition. Repairing guns and keeping target faces and mats in good condition can save money and make shooting experiences more successful.

### ***Eye Protection***

Eye protection must be available for all individuals on a BB Gun range. The best ones are those with side shields.

### ***Backstops***

Baled straw stacked behind the target will stop shots. Also, several layers of burlap, old canvas, or rugs hanging loosely over a horizontal pole or plank 1 or 2 inches wide will stop many shots. If tarps are used, check them for weakness during the season. Heavy duty moving blankets may also be used as long as it is monitored.

***Cub Scouts (except for Lion Scouts) can earn the BB gun elective adventure for their rank. Information on these electives can be found at [www.scouting.org/outdoorprograms](https://www.scouting.org/outdoorprograms).***

### **How To Set Up Outdoor Target BB Gun Range**

Set up for wide-open, cleared space. Utilize the range design guideline for BB gun ranges #314. You can download the range design guidelines at <https://www.scouting.org/outdoor-programs/properties/resources/design-guidelines/>.

1. Select the Orientation of the Range
  - Avoid shooting into the sun by facing North.

- The ground should be flat and free of obstacles.
- Look for a natural backstop such as a berm to stop BB's, or a ballistic cloth or double layer, heavy duty tarp capable of stopping a bb as a trap. If there is no berm, provide a minimum of 195 yards of open area behind the targets.
- The safety zone on the side should be 30-50 feet.

### 2. Place Range and Safety Lines

- Rope, eco-friendly spray paint or chalk are ways to lay down the range lines outdoors. Follow the guidelines illustrated on the following page.
- Shooting Line – The Shooting Line is between 15-30 feet from the Target Line depending on the skill level of the participants.
- Waiting Line – Shooters stand behind the Waiting Line before and after shooting their arrows. It is meant to act as a safety area between the class and the Shooting Line. The Waiting Line is placed 15 feet behind the Shooting Line.
- OPTIONAL: Controlled Access/Spectator Line – Anyone who wants to watch participants shoot can gather behind this line. This line needs to be placed far enough behind the Waiting Line to prevent distraction from the spectators (at minimum 15 feet)

### 3. Set Up Targets

- Place targets in front of the natural berm. If a natural berm is not available, place targets in a wide-open space with a minimum safety zone of 150 feet behind the targets.
- Evenly space targets in front of the berm. Space between targets is dependent on placement of shooting positions.
- One method of hanging targets is to put up posts to hold “snow fence.” Attach the snow fence to the posts. Targets can be attached to the snow fence with clothes pins.
- A temporary target holder can be made using old political signs with their wire ground stands. (Paint over the political signs if they are used.)

### 4. Place the Equipment

- Eye protection should be available in the waiting area. All participants on the range must wear eye protection.
- BB Guns – May be on the top of the bench if using bench rest positions, or on the mat used for the prone positions. If shooters are shooting from the free-arm standing position, there should be some type of stand where the guns may be placed when not in use.
- BB's – Should be between the shooting line and the ready line under the control of the rangemaster.



## ARCHERY

Archery is a colorful, interesting, and worthwhile activity for youth. The beginner gets immediate satisfaction yet finds a continuous challenge as they develop into a skilled archer. This activity provides good physical exercise and develops powers of concentration and coordination.

The goal is to teach Lion and Tiger Cubs with their adult partners, Wolf Cub Scouts, Bear Cub Scouts, and Webelos and Arrow of Light Scouts how to use the bow and arrow safely. Archery is approved for all levels of Scouting.

### A Brief History of Archery

The advancement of civilization was enhanced by the use and discovery of bows and arrows. The bow and arrow provided a much safer way to hunt and made life easier.

Generally it is thought the spear was the predecessor to the bow. Spearheads have been discovered from many thousands of years ago.

A recognizable bow was discovered dating back to 6000 B.C. that was made from yew or elm.

Egyptians, somewhere around 3500 B.C. to 2800 B.C., are considered the first to use the bow in battle, which gave them superiority over their enemies. This bow was known as a composite bow.

Assyrians developed a shorter recurve bow that provided more power and easier handling around 1500 B.C. Crossbows were also used in ancient China.

About this same time, the Parthians became famous for shooting backwards while riding a horse. The term “Parthian shot” is still used today in archery.

Heracles, a Greek hero, was very well known for his help with the siege of Troy around 1260 B.C.–1240 B.C. As a direct result of Heracles’ help, the city of Troy fell through the use of the Trojan Horse.

Around 1200 B.C., a famous Egyptian pharaoh named Rameses II gave archery another boost by putting archers on chariots. This mobility allowed the Egyptians to defeat the Hittite army.

Through the course of time the wooden bow was made longer. The British were famous for improving on the bow, which eventually became known as the British longbow. The most famous battle of the longbow was the battle of Crecy in 1346. In 1500, crossbows were banned in England to promote the use of the longbow. In 1595, the army was ordered to replace all bows with muskets. However, archery has remained a popular sport activity in England.

Some of the first archery clubs were formed in England. Competitions were part of their way of life. The English are noted for the three forms of shooting. Butt shooting is where targets are mounted on mounds at 100 to 140 yards. Clout shooting is where targets

are mounted on the ground with a wooden stay in the center. For these two forms, arrows are shot upward to descend on the target. For the third form of shooting, roving archers shoot at simulated small animals over varying ranges on unprepared ground and courses.

Around 1000 A.D., bow and arrow technology swept the Americas. As seen through archeological studies, its use was adopted by most prehistoric native Americans.

In 1879 the National Archery Association was founded. The first national tournament was held in White Stocking Park in Chicago the same year. The first archery club in the United States, the United Bowmen of Philadelphia, was founded in 1928.

In 1900 archery became part of the Olympic games. It was dropped after 1920 because the wide range of rules could not be standardized. In 1931, the Federation Internationale de Tir à l’Arc (FITA) was founded in Paris and standardized the rules for international competition, but it was not until 1972 that archery was again a part of the Olympic program.

### Leadership

Archery must be conducted by trained, qualified on-site Rangemasters who direct the operation of the range program and archery instruction. To qualify as an archery Rangemaster, the Rangemaster must be at least 18 years old and be trained by a National Camping School-trained range activities director or a USA Archery/NFAA instructor.

The local council issues a Training Course Pocket Certificate, No. 33767, and keeps a record of those who have been certified. Archery Rangemaster, course code CS 31. Certification must be renewed every two years.

### Training Cub Scouts

The objective is to teach Cub Scouts how to shoot a bow and arrow and to have fun safely.

This instruction is designed for immediate participation and success. For example, beginning archers tend to shoot high because they want to look at the point of their arrows. By placing the bottom of the targets on the ground at 10 yards, rather than at the traditional 48-inch level at 25 yards, fewer arrows miss the target. This means more class time can be spent on shooting and less on looking for arrows.

Before handing out equipment, check each archer’s eye dominance, page 66. Also, look for loose objects on the archers such as pins, pencils, loose sweaters, and watches that could get in the way of shooting.

For the best learning experience, give each Cub Scout a bow, an arm guard, a finger tab, a quiver, and six arrows. If it is not possible for each to have a bow, one bow might be shared by two or more archers.

Caution the class to hold the items but to not shoot until you give exact instructions to do so. Bows should already be strung at the first session. Stringing and unstringing bows may be taught later.

For beginning instruction, have left-handed archers grouped at the right end of the shooting line to allow them a better view of the Rangemaster as they demonstrate.

Instruction takes place at the shooting line. Explain the use of whistles, page 66.

### **Teaching Tips**

The coach-pupil method is effective for all types of skill training and is particularly effective in range and target activities. To put this method into practice:

1. Put the bow in the archer's hand as soon as possible so they can understand the tool while the basics are explained.
2. Group archers into pairs (Scout and parent/guardian would be ideal.) Check for loose items on the bow side of the archer that could interfere with their shooting.
3. The instructor demonstrates the activity or action to be followed before the whole group. When demonstrating techniques, be sure to do them correctly. The instructor then circulates among the pairs, giving a word of advice or assistance, recognizing good work, correcting errors, and determining how well the archers understand the method.
4. Check the archer's finger tab closely before they shoot. Watch for four fingers on the string. Look for cramped fingers on the bowstring. Watch the thumb on the drawing hand. If an archer masters the draw and anchor quite readily, stand behind them and check that when the string is released it will not hit the arm or chest of the archer when they shoot.
5. The archer practices while their partner coaches. Let archers shoot the first arrow as soon as possible, even if the bow hand, anchor, draw, etc., are not perfect.
6. At a predetermined signal, the positions are reversed if using coach/pupil.
7. Progressively, archers are learning by observing, by doing, and by coaching.
8. Use a positive approach. Use praise sincerely. Before making a correction, figure out the fault to find the cause. Never correct a student after spotting a fault on one arrow shot.

9. Avoid long discussions on learning the parts of equipment used. Teach just enough so archers will know how to safely use the equipment.
10. Allow each archer to feel the satisfaction of hitting the target as quickly as possible.

## **Cub Scout Archery Training—Youth**

### **Section I (20 minutes)**

- A. Safety Guidelines, page 66
- B. Equipment, page 69
  1. Review bows, bowstrings, arrows, arm guards, finger tabs, quivers, points of aim, target butts, target faces, and backstops.
  2. Review how to maintain, store, and care for equipment.
  3. Review how to string and unstring a bow. (*Optional*)

### **Section II (40 minutes)**

- A. Archery Shooting Basics, page 66
  1. Eye Dominance, page 66
  2. Stance, page 66
  3. Nock the Arrow, page 67
  4. Establish the Bow Hold, page 67
  5. Draw, page 67
  6. Aim, page 67
  7. Anchor, page 67
  8. Release or Loose, page 67
  9. Follow-Through, page 67
  10. Retrieve Arrows, page 67
- B. Practice, practice, practice

### **Section III (60 minutes) (*optional activities*)**

- A. The difference between an End and a Round, page 68
- B. Archery Games & Activities, page 68
- C. Cub Scout Awards Archery Elective Adventures (Visit [www.scouting.org/outdoorprograms](http://www.scouting.org/outdoorprograms))

## **Lion and Tiger Cubs and Archery**

Lion and Tiger Cubs and their adult partners may participate in archery activities. The adult partners must be included in all archery activities. Each Lion and Tiger Cub must be paired with their adult partner before being allowed to shoot.

Keep in mind that youth of this age have very short attention spans (20 to 30 minutes maximum), and tire easily. They probably have little previous experience working as a group and may require more time to understand how the range operates. Lion and Tiger Cubs have a wide range of ability and experience levels, so be ready for anything!

## Safety Guidelines

Lion and Tiger Cubs with their adult partners, Wolf Cub Scouts, Bear Cub Scouts, Webelos Scouts, and Arrow of Light Scouts should learn these simple safety rules. When training archers to shoot, be sure to have the proper equipment, secure and safe ranges, and clear safety instruction.

1. Observe all state and local laws on using a bow and arrow.
2. Shoot only with proper range supervision.
3. Always check your equipment before shooting. All defective equipment should immediately be removed from the range.
4. Be sure to include all of the safety guidelines and the proper whistle codes.
5. Bows and arrows should be used only in places set aside for their use.
6. Use only arrows that have been measured for your proper draw length. Arrows that are too short may cause personal injury or damage to the bow and arrow.
7. Always wear an arm guard and finger tab or glove.
8. Keep the arrows in the quiver until everyone is on or behind the shooting line and the Rangemaster has indicated that you may get in proper shooting position.
9. **Archers straddle the shooting line, with one foot on either side.**
10. Always keep your arrows pointed down or toward the target.
11. Only release an arrow when you can see its full clear path to the target.
12. Shoot only at the target in front of you.
13. Stop shooting immediately upon signal from the Rangemaster or if anyone crosses in front of the shooting line or in front of or behind the targets.
14. Always walk, never run, when on the archery range or while carrying arrows.
15. Stay on marked paths. Travel the direction in which the targets are marked.
16. On a target range, leave the bow at the shooting line.
17. Always practice courtesy and good sportsmanship.

### *Know the Proper Whistle Codes*

**Two blasts.** Move up to the shooting line.

**One blast.** Fire the proper number of arrows.

**Three blasts.** Cease firing. Move to the target. Retrieve and score arrows.

**Five or more whistle blasts.** Cease firing. Stay where you are. This is an EMERGENCY. Officials will tell the archers what action to take either verbally or by whistle code.

Remember, there is only ONE command to shoot – ONE blast of the whistle.

For any command of more than one blast, STOP shooting. Watch and listen for further instructions.

## *Sun Safety on the Archery Range*

The American Academy of Dermatology advises the following protection tips against damaging rays:

- Limit exposure to sun between 10 a.m. and 4 p.m. when the sun's rays are the strongest.
- Generously apply sunscreen with a sun protection factor (SPF) of at least 15 and reapply it every two hours when outdoors, even on cloudy days.
- Wear protective, tightly woven clothing, such as a long-sleeved shirt and pants.
- Wear a hat with a wide, 4-inch brim and sunglasses with UV protective lenses.
- Stay in the shade whenever possible.
- Avoid reflective surfaces, which can reflect up to 85% of the sun's damaging rays.

## **Archery Shooting Basics**

The following instructions are written for right-handed archers. When training left-handed archers, reverse the instructions as necessary.

### *Eye Dominance*

Before shooting a bow, the archers should determine which eye is dominant. Just as people are either right- or left-handed, one eye is more dominant than the other. Discovering which eye an archer favors is important because it could determine on which side the bow should be held.

To find which eye is dominant, have archers extend both arms in front of them and form a small hole with their thumbs and index fingers. Instruct them to look at a distant object through the opening and then pull their hands back to their face. The eye that is in line with the object is dominant.

Assign archers, leaders, and parents in pairs to assist each other, then have them check with the Rangemaster.

***Archers should usually draw back the bowstring with their dominant hand, even if it does not match their dominant eye. If they are cross-dominant, you may suggest they close their dominant eye while shooting.***

### *Stance*

Stance is the correct foot position of the archer. The goal is to provide a solid foundation for the shot. An archer is most stable in an open stance.

1. Stand with feet **straddling** the shooting line.
2. Feet should be about shoulder-width apart.

3. Move the foot closest to the target back about 3 inches.
4. Turn the toes of both feet toward the target about 30 degrees.

### ***Nock The Arrow***

To nock the arrow is to securely place the arrow on the bowstring. When the arrow is securely placed on the bowstring the archer feels and/or hears the arrow “snap” into place.

1. Grasp the arrow below the nock.
2. Bring the arrow up and over the bow and place it on the arrow rest.
3. Spin the arrow so the index vane (usually a different color) points away from the riser (bow) and towards the archer’s body.
4. Push the nock into place on the bowstring directly below the nocking point.

### ***Hook and Grip***

Archers touch the bow in only two places: the bowstring where they “hook” it, and at the grip where they “grip” the bow. *Hook* is when an archer curls three fingers around the bowstring directly beneath the arrow. The *grip* on a bow is where the archer places their hand on the bow.

1. Curl the bowstring with the fingertips of the index, middle, and ring fingers under the arrow.
2. Pull the bowstring back enough to apply a small amount of tension.
3. Center the meaty part of the thumb on the back of the bow grip.
4. Point the thumb toward the target and angle your knuckles 45 degrees. Check to be sure the grip is relaxed.

### ***Raise the Bow***

This step gives the archer the opportunity to confirm that all previous steps have been completed before proceeding. Once that is done, do the following:

1. Turn the head toward the target.
2. Rotate the elbow of the bow arm away from the bowstring.
3. Lift both arms to shoulder height.
4. Extend the bow arm fully, keeping the bow vertical.

The archer raises the bow in preparation for drawing back the bowstring. This gives the archer a sense of direction by knowing where the bow is in relation to the target. While raising the bow, it is important to keep the rest of the body still.

### ***Draw***

Pull the bowstring back toward the face. The draw is seamless and smooth.

### ***Anchor***

The archer should pull the bowstring back to a consistent anchor point every time to maintain accuracy. For beginning archers, the corner of the mouth is the preferred anchor point.

1. Settle the index finger of the draw hand into the corner of the mouth.
2. Keep the draw hand relaxed and against the face.

### ***Hold***

Move the draw arm elbow slightly behind the arrow to brace the draw weight of the bow. The tension of holding the bow is not transferred from the shoulder and arm muscles to the back muscles

### ***Aim***

Aim is lining up the arrow to the target. Simply put, the arrow will go where it is pointed. The goal is to focus equally on the target and the arrow point.

1. Place the point of the arrow on the intended target area.
2. The eye focus is equally on the arrow point and the target.

### ***Release/Follow-Through***

Release occurs when the archer relaxes the tips of the fingers that are hooking the bowstring, allowing the bowstring to push the fingers out of the way. Follow-through is the finish position.

1. Relax the fingertips to allow the bowstring to push the fingers out of the way.
2. Keep the bow arm up.
3. Finish the shot by allowing the draw hand to fall between the ear and the shoulder.

### ***Retrieve Arrows***

After all archers have shot their allotment of arrows (usually around five, if time permits), demonstrate and explain the proper methods to retrieve arrows from the target and ground.

First, before any archer goes to retrieve arrows, permission must be granted by the range officer. The range officer will observe the archers and indicate when all archers have completed shooting and it is safe to retrieve arrows.

1. Follow the proper commands to move to the target line. (*Three whistle blasts.*) Archers should walk slowly to the target line and watch for arrows on the ground.



2. Remove arrows by standing to the side of the target and brace it with the side of the body. Place one hand on the target at the base of the arrow. **(If two people are shooting at the same target, only one should remove their arrows at a time. The other archer should stand back at the target line.)**
3. Grasp the arrow near the target and pull firmly and slowly straight back toward the shooting line.
4. Place the arrow on the ground.
5. Remove the others in the same manner and place them on the ground.
6. After all the arrows have been removed, pick up the arrows from the ground. Cover the points with one hand and grasp the arrows near the fletchings (vanes) with the other hand. If an arrow is buried under the grass, it should be withdrawn by pulling it forward without lifting until it is clear of the grass.
7. Walk back to the shooting line carrying the arrows parallel to the ground with both hands in front of the body. Place the arrows into the quiver, point down.
8. Move off the range, or prepare to resume shooting as commanded.

### Archery Games and Activities

A variety of games or activities can be done using archery skills. Different ranges could be set up to play a particular game, or courses could be set up where archers go from station to station. Archery games and alternate activities work well, especially when archers are in camp for more than one day or if a council sponsors a special archery camp for Cub Scouts.

**Remember, any place there is an archery range and there is archery shooting, even when playing a game or activity, a qualified archery Rangemaster must be present.**

Shooting games are designed to improve shooting skills. Remember, safety is a must.

The following activities and opportunities would be appropriate for Lion and Tiger Cub Scouts with their adult partners, Wolf Cub Scouts, Bear Cub Scouts, Webelos Scouts, and Arrow of Light Scouts.

#### *Shooting a Competitive Round*

When shooting a competitive round, an “end” is shooting six arrows at a target. A “round” is the total number of ends to complete the round.

**For example:** An **American round**, in archery, a target-shooting event consisting of **five ends** (six arrows each), shot from distances of 60, 50, and 40 yards

### *Tic Tac Toe*

Place a Tic-Tac-Toe grid on a target back (You can use flip-chart paper to make the grid or put up nine separate sheets of paper in a 3x3 grid pattern.) Divide the group into two lines, and have them stand in a single file 20 feet from the target. Each team will alternate their archers. Each archer will shoot one arrow and step back. The second and each succeeding archer will shoot one at a time. The first team to get complete a horizontal, vertical, or diagonal row wins.

### *Wand Shooting*

Place a strip of 1-inch masking tape over the target face from top to bottom. A point is scored when an arrow hits the tape anywhere on the target. Divide the group into two lines, and have them stand in a single file 20 feet from the target. At the signal to shoot, each archer will shoot one arrow and step back. The second and each succeeding archer will shoot one at a time. The first team to get two points is the winning team.

### *Balloon Bust*

Place a variety of balloons on a target mat. (They may be different sizes and colors.) Divide the group into two lines and have them stand in a single file 20 feet from the target. At the signal to shoot, each archer will shoot one arrow and step back. The second and each succeeding archer will shoot one at a time. The first team to break a set number of balloons is the winning team.

### *Archery Practice Fun*

Any station set up for participants to practice skills can be fun for Cub Scouts. The archers have limited times to shoot arrows, so the opportunity to practice at a council camp or event is a great experience for them.

### *Range Layout*

**A sample outdoor archery range layout is posted online at <https://www.scouting.org/outdoor-programs/properties/resources/design-guidelines>.** Safety is a primary concern when operating an archery range, and the safety rules must be followed.

If at all possible, the range should be laid out so shooting is done in a northerly direction so archers are never facing the sun. To protect arrows, all outcropping rocks should be reduced to ground level. Grass should be planted so a good sod is developed. Keep grass cut close and raked clear. Sandy soils need no ground cover.

Important! Arrange facilities so there is no possibility of non-participants inadvertently walking behind the targets while shooting is in progress!

**Inflatable Ranges** Only commercially manufactured equipment is allowed to be used. *(This activity must be supervised by a Scouting America certified Archery*

Rangemaster or USA Archery Level 1 or higher instructor.)

If an inflatable range is utilized, appropriate side and rear boundaries must be in place. (Minimum 10 ft. on the side, 15 ft. behind the target zone and 15 feet behind the shooting line.) There must also be a distinct gated entrance to access the shooting line. (*Manufacturers guidelines must always be followed if they are more stringent, and you may only use manufacturers recommended equipment.*)

### Range Operation Rules

1. Never operate a range without adult supervision.
2. Be sure all safety rules are understood and followed.
3. Range flags must be flown while the range is in use.
4. Check all equipment before using to be sure bows, bowstrings, and arrows are in safe condition.
5. All spectators and archers waiting to shoot must remain behind the waiting line at least 3 yards behind the shooting line.
6. Archers must wear shoes on the range at all times.
7. Archers may not allow anyone to hold a target for them.
8. Archers must not talk or disturb shooters on either side when they are shooting.
9. Archers stay on the shooting line until their target partners have shot their last arrows, and then both step back together.
10. Use the proper whistle codes.
11. Use the proper scoring techniques.
12. Always walk on the range.

### Sample Range Rules Poster



## ARCHERY RANGE RULES AND COMMANDS

#### ARCHERY RANGE RULES

1. Always walk on the range.
2. Keep your arrows in your quiver until you are told to shoot.
3. Only release the bow string when an arrow is nocked and safely pointed toward the target.
4. Leave dropped arrows on the ground until instructed to retrieve them.

If there is an emergency on the range, immediately tell the instructor.

#### WHISTLE COMMANDS

- 2 WHISTLE BLASTS = Go to the line.  
 1 WHISTLE BLAST = Shoot.  
 3 WHISTLE BLASTS = Retrieve arrows.  
 5 OR MORE WHISTLE BLASTS = Emergency. Immediately stop shooting, return bows to the rack, and go behind the waiting line.

(From USAA Archery Certification Course – Level 1 manual. Used with permission.)

This poster can be found in the Appendix of this guide.

### Equipment

When not in use, archery equipment must be kept in locked storage to protect it from weather, rodents, and theft.

### Bows

The two most common bows used by Cub Scouts are:

**Recurve:** Recurve bows are the traditional bows for learners. It allows the archer to better learn the proper finger tension. Modern recurve bows are made entirely either of fiberglass, or a composite of wood and fiberglass. Both options are satisfactory for beginning instruction.

**Compound:** Compound bows are generally harder to master, but they will produce more consistent results. The pulley system provides a mechanical advantage to assist where strength or stamina is an issue.



## TYPES OF ARCHERY BOWS

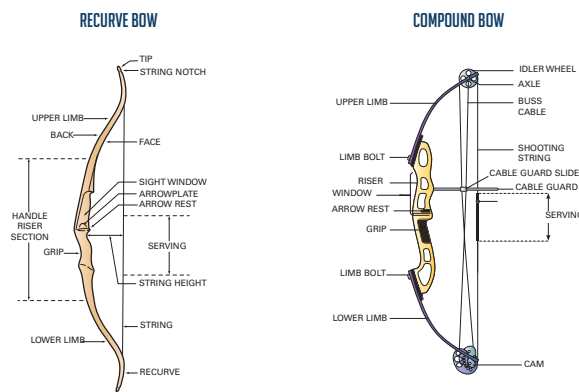

This poster can be found in the Appendix of this guide.

### Care of Bows

Some basics to follow in the care of your bows whether they be wood, metal or fiberglass:

- Never lay a bow on the ground.
- Never stand a bow on end.
- Store bows by laying them on pegs that support the bow in the handle riser section.
- Although finishes are waterproof, it is best to dry the bow if it gets wet. Bow wax will help preserve the finish on the bow.
- Carry a bow unbraced (unstrung) in a bow case to protect it from scratches and possible damage.
- Never leave a bow in an automobile as the heat from the sun may cause damage. Store bows unstrung and, if possible, in a cool place with moderate humidity.

### Bowstrings

Keep the bowstring well waxed with either a commercial bowstring wax or one you make yourself using one part resin to three parts beeswax.

Inspect the string carefully before and after each day's shooting. If any of the strings are broken, discard the string. Check the serving and repair or replace it if it is loose or worn.

Replacement bowstrings should be ordered according to the length and weight of the bow. If a bow is marked 56 inches, 20 pounds, order a 56"-20# string. Do not order by the actual measured length of the string.

### ***Bow Stringer***

Always use a bow stringer to string a recurve bow. The step-through and push-pull methods can cause permanent damage to bows by twisting their limbs. A bow-stringer is a piece of string about 5 feet long that has a leather cap at each end. The larger cap attaches over the bottom bow notch and the smaller cap goes over the upper bow notch. The top cap is small enough for the bowstring to be slipped into the bow notch.

To string a bow, position the bottom end of the bowstring in the bottom notch and slip the caps of the bow-stringer over the ends of the bow. Holding the bow by the grip, allow the stringer to rest on the ground. Step on the center of the bow stringer and smoothly pull upward on the bow grip to tension the bow. Using the thumb and index finger, slide the top loop of the bow-stringer into the upper bow notch.

Check the bow to make sure the bowstring is properly in place. To unstring a bow, tension it and guide the top loop down. Bows that are not in use should be unstrung before being stored.

### ***Arrows***

A shaft made of carbon, aluminum, wood, fiberglass, or composite materials with a point on one end and a nock on the other end. Fletching, which can be either feathers or plastic vanes, are located on the arrow near the nock end.

One way to determine if an arrow is long enough for an archer is to place the nock of the arrow in the center of the chest and hold the shaft with both hands extended in front of them. The point of the arrow should extend at least one inch further than where their hands come together.

**Field point:** Similar to a target point and has a distinct shoulder, so that missed outdoor shots are easier to remove from obstacles such as tree stumps.

**Fletching:** The stabilizing feathers or vanes of an arrow.

**Index fletch or vane:** A different-colored fletch or vane used to indicate proper arrow positioning in relation to the bowstring or bow.

**Nock:** The plastic attachment or grooved notch at the end of an arrow used to attach the arrow to the bowstring.

**Shaft:** The main structural element of an arrow.

**Target point:** Attached to the front end of the arrow and penetrates the target.

### ***Care of Arrows***

Feathers on arrows should be kept dry. If the feathers become wet, wipe them dry and clean before storing. Separate the arrows until they are dry to allow the feathers to expand and regain their original shape. If the feathers are matted down, they can be steamed to return them to their original shape.

Discard any fiberglass or wooden arrows that have splinters or cracks in the shaft.

The arrows can be kept in the quivers during the season, but if they are not going to be used for several months, it is best to store them in the boxes in which they were received. These boxes have individual holes for each arrow. This will preserve the feathers and help prevent wooden arrows from warping.

### ***Arm Guards***

The arm guard is either leather or plastic with at least two elastic straps. It is slipped over the forearm that holds the bow and provides protection from the slap of the bowstring after the arrow is released.

### ***Care of Arm Guards***

Arm guards should have laces or elastic replaced when needed. Arm guards should be kept in labeled boxes. All leather goods will last longer if stored in a cool, dry place and occasionally cleaned with saddle soap.

### ***Finger Tabs***

Finger tabs are preferable to gloves for group instruction because they present fewer fitting problems. Made of smooth leather, finger tabs absorb the friction of the bowstring across the fingertips. Without them, painful blisters can develop. Many designs are available, but for beginners the simplest and most inexpensive type is satisfactory.

***Every Cub Scout archer must use an arm guard and finger tabs.***

### ***Quivers***

For novice shooters, having a quiver to use when returning arrows from the target to the shooting line will improve safety procedures.



## Targets and Scoring

### Target Butts

Targets for beginners should be about 48 inches in diameter and made of straw or Ethafoam. The target butts are placed on soft-pine tripods, about 6 inches off the ground. (Ethafoam is the proper material for a target butt. Plastic foam is messy and does not last long.) Keep the targets close to the ground so missed arrows will not go far and so younger archers can reach the highest arrows easily.

Three to five bales of straw may be stacked to serve as target butts. Make sure the bales are tied back to a post so they will not fall forward on someone pulling arrows. Care should be taken in stacking the bales to be sure they are very close together. Keep the bales off the ground by stacking them on old tires.

### Target Faces

The 48-inch standard target face is recommended for use on outdoor ranges. These are printed on several types of material, including heavy paper, canvas, and oil cloth. If you use paper targets, paste them to light cardboard or they will not last long. Smaller targets are made to be shot at from shorter distances.

The target is made up of five concentric color zones. Each zone is divided by a thin line into two scoring zones of equal width. Each circle represents the following point values:

- Inner gold = 10 points
- Outer gold = 9 points
- Inner red = 8 points
- Outer red = 7 points
- Inner blue = 6 points
- Outer blue = 5 points
- Inner black = 4 points
- Outer black = 3 points
- Inner white = 2 points
- Outer white = 1 point

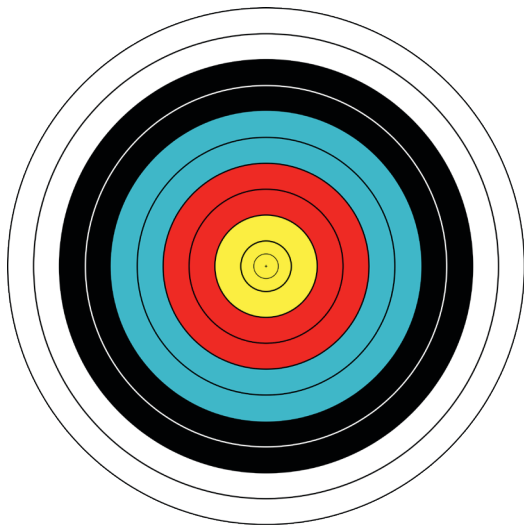

### Care of Target Faces

Target faces should be removed from mats when the mats are being moistened. Masking tape applied to the back of a target face that is tearing from much use will help it last longer. Center patches that cover the gold and part of the red scoring areas on the target face will double the life of the target faces. The patches must be carefully aligned so the lines marking the scoring areas line up exactly.

### Backstops

Baled straw stacked behind the target will catch wild shots. Also, several layers of burlap, old canvas, or rugs hanging loosely over a horizontal pole or plank 1 or 2 inches wide will stop arrows that miss the target. These materials will last much longer if they can be rolled up and stored between seasons.

### Cub Scout Archery Elective Adventures

All Cub Scouts can earn the archery elective adventure for their rank. Information on these electives can be found at [www.scouting.org/outdoorprograms](http://www.scouting.org/outdoorprograms).

## How To Set Up Outdoor Target Archery Range

Utilize the Cub Scout archery range design layout #315 which can be downloaded at <https://www.scouting.org/outdoor-programs/properties/resources/design-guide-lines>. Set up for wide-open, cleared space.

### 1. Select the Orientation of the Range

- Avoid shooting into the sun by facing North.
- The ground should be flat and free of obstacles.
- Look for a natural backstop such as a berm to stop arrows. (If there is no berm, provide a minimum of 150 feet of open area behind the targets.)
- The safety zone on the side should be 30-50 feet.

### 2. Place Range and Safety Lines

- Rope, eco-friendly spray paint or chalk are ways to lay down the range lines outdoors. Follow the guidelines illustrated on the following page.
- Target Line – The purpose of the Target Line is to provide archers a safe place to stand when waiting for their turn to pull arrows from the target.
- Shooting Line – The shooting line is placed close enough to the Target Line to ensure success for the archers to hit the target. This line can be moved back to greater distances as archers become more advanced. The Shooting Line is placed 15-30 feet from the Target Line.
- Waiting Line – Archers stand behind the Waiting Line before and after shooting their arrows. It is meant to act as a safety area between the class and the Shooting Line. The Waiting Line is placed 15 feet behind the Shooting Line.
- OPTIONAL: Controlled Access/Spectator Line – Anyone who wants to watch archers shoot can gather behind this line. This line needs to be placed far enough behind the Waiting Line to prevent distraction from the spectators (at minimum 15 feet)

### 3. Set Up Targets

- Place targets in front of the natural berm. If a natural berm is not available, place targets in a wide-open space with a minimum safety zone of 150 feet behind the targets.
- Evenly space targets in front of the berm. It is best to place the targets five feet, or two arrow lengths, from target-center to target-center. Evenly spaced targets allow for multiple people to shoot at the same target safely.

### 4. Place the Equipment

- Bows – The bow rack is placed between the Waiting Line and the Shooting Line. The bows are placed in the bow rack.
- Ground Quivers – Ground quivers are evenly spaced apart on the Shooting Line. Two quivers per target are suggested.
- Arrows – Place arrows in a central location near the bow rack. Once the instructor is comfortable with an archer's skill level, arrows may be placed in each individual archer's ground quiver.



## SECTION VI

### **OTHER RANGE AND TARGET ACTIVITIES FOR ALL PROGRAM LEVELS**

The information in Section VI explains additional range and target activities and their related safety concerns. These activities are appropriate for all program levels, from Cub Scouting through Sea Scouting. An extensive resources chapter provides useful information on advancement and recognition and for conducting these activities.



## CHAPTER 10: OTHER RANGE AND TARGET ACTIVITIES FOR ALL PROGRAM LEVELS

Many council programs have range and target activities that include slingshots, catapults, balloon launchers, rockets, and some other creative devices. These items are fun and, in most cases, seem harmless. However, any type of range and target activity can be dangerous, and if safety precautions are not taken, accidents can happen easily. Great care should be taken that safety is the key factor for any activity where items are shot through the air.

Before starting any range and target activity adults are expected to follow the SAFE checklist and all activities must fit within the age appropriate guidelines of Scouting America.

- Airsoft is not an approved shooting activity for Cub Scouts. It is approved for Scouts BSA, Venturers and Sea Scouts.
- Chalkball/Paintball markers are not approved for Cub Scouts. Scouts BSA, Venturers, and Sea Scouts may only use chalkball/paintball markers to shoot at approved targets—never at another person as part of an approved chalkball program.
- Marshmallow shooters or blowguns or any device where breath is used to expel the projectile, as well as devices that require a straw or similar device in the mouth are not approved.
- All range and target activities must be approved by the council range and target activities committee or a National Camping School certified range activities director.
- The use of catapults or other shooting devices must be approved by the council range and target activities chair or a National Camping School certified range activities director and must use appropriate projectiles. (Pumpkins and projectiles larger than a tennis ball are not authorized).
- A safe range must be provided for any activity, such as catapults, that involves shooting objects or water into the air.
- Proper supervision as described in earlier chapters is required for each of these activities.
- See Appendix for a list of additional unauthorized range and target activities.

### Safe Ranges

A safe range must have three things:

1. A safe area
  2. A safe distance
  3. A safe backstop as appropriate for discipline
1. Safe area. Whether inside or outside, be sure the range is set up so no one can accidentally walk in front of the firing line.
  2. Safe distance. Maintain at least 15 feet between the participant and the target.

3. Safe backstop. A backstop designed to keep projectiles from leaving the range. Do not shoot at a hard surface that could cause a ricochet.

### Pellet Rifles

**The use of pellet rifles by Webelos and Arrow of Light Scouts is restricted to a long-term camp setting and only qualifies when in compliance with the following requirements. Lions, Tigers, and Cub Scouts are not permitted to shoot pellet rifles.**

- The pellet rifle range meets or exceeds Scouting America and National Rifle Association recommendations, including nearby latrine facilities, drinking water, first-aid kit, and emergency communications. See Outdoor Programs/Properties design standards on the Web at [www.scouting.org/properties](http://www.scouting.org/properties).
- Pellet rifles in good repair are provided and must be appropriately sized for participants.
- If any trigger mechanism fails, the air rifle is immediately removed from service. Documentation of the tests is maintained.
- For Webelos and Arrow of Light Scouts all pellet rifles (CO<sub>2</sub>, pump, break barrel, etc.) are limited to single-shot designated for target shooting, velocity of 500 to 540 feet per second, and every level not to exceed 7.5 joules.
- Safe, separate, and locked storage (can be the same building) is provided for pellet rifles, pellets, and CO<sub>2</sub> cylinders and bulk tanks.
- For supervision requirements and shooting experience see charts in Chapter 1.
- A handwashing station (with soap and cold water) is available for all participants to use upon leaving the firing line.
- **THERE IS NO EATING OR DRINKING ON THE FIRING LINE.**

### Slingshots and Wrist Braced Slingshots

Using slingshots is an affordable, fun activity in camps and many Scouts have not had previous experience with them. Although exciting and fun, slingshots are not toys. Scouts must understand that they must follow the rules when shooting or they will not be allowed to participate.

Shooting items from slingshots and wrist braced slingshots can be dangerous. For these activities, follow the same safety guidelines and rules as used for BB gun shooting. Always shoot at an approved range following the design guidelines for either an archery or BB gun shooting range.

## **Slingshot and Wrist braced slingshot Guidelines**

(Instructions are for right eye dominant participants. Reverse instructions for left eye dominant participants where applicable.)

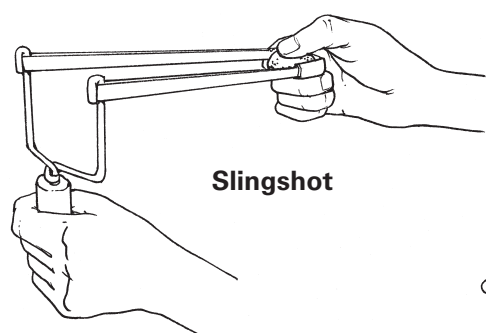

**Slingshot**

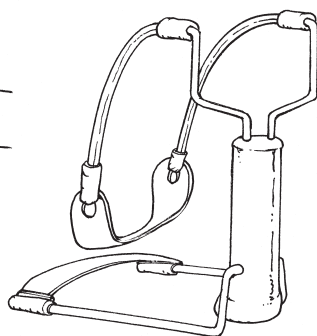

**Wrist braced slingshot**

### **Equipment**

Slingshots are usually fork-shaped (Y) and made from very strong and durable wood or aluminum. Broom wood, which is both strong and lightweight and lends itself to carving, is also good for slingshots.

Wrist braced slingshots are a type of slingshot. They are designed to brace against the wrist and therefore seem to be steadier.

Many companies sell excellent slingshots and wrist braced slingshots. Companies that sell BB guns or archery equipment would be good resources for these items. Less expensive slingshots are available in many retail locations. When choosing the slingshot for your camp or activity, consider the experience level of your participants and make sure to obtain devices that are appropriately sized and of good quality.

### **Targets**

Targets for slingshots can be made from a variety of materials, including paper, cans, plastic bottles, and balloons. Paper targets can be homemade or purchased. Cans are excellent as they make a great sound when hit. Cans, plastic bottles, and balloons can be hung from strings or attached to netting. A sample target is shown on page 88. Practice with the slingshot or wrist braced slingshot on a bull's-eye about 2 inches in diameter and with the target 10 feet away, then move the target out to 25 feet.

### **Slingshot ammunition**

\*Do not use glass, steel, marbles, rocks or any other hard objects that may ricochet.

\*Paintball/chalkball or clay balls are acceptable (must be approved for the range in use.)

\*Use of small food items while not prohibited may be suitable for younger Scouts but may attract unwanted wildlife.

1. A certified BB Rangemaster must be present on the range and oversee the program.
2. A 1-to-1 adult-to-participant ratio must be used for Cub Scout level shooting and a 1:4 adult to participant ratio must be used for all other levels in Scouting.
3. Use a safe shooting range such as a BB gun range or archery range.
4. Properly sized protective eyeglasses or goggles must be worn by participants, adult helpers and rangemaster.
5. Participants must only pick up devices when instructed to do so.
6. Participants must only shoot when instructed and have a clear view of the target and what is beyond it.
7. If a slingshot becomes damaged during use or appears to be worn, this slingshot must be taken off the line and repaired or replaced.
8. Slingshots must only be aimed downrange in a safe direction and not into the air.
9. Participants must stay behind the firing line while shooting is taking place.
10. Participants should point their left foot and shoulder directly at the target with the body turned to the right and turn their head directly toward the target.
11. Center the ammo in the middle of the pouch. Hold the handle firmly in the left hand and pinch the ends of the pouch together with the thumb and index finger of the right hand, encompassing the ammo.
12. Hold the left arm out straight and firm. Draw the right hand back level with right cheek—NEVER TO THE EYE—while holding the pouch securely between the thumb and index finger of the right hand.
13. Aim and release the ammo pouch to shoot.
14. Always practice courtesy and good sportsmanship!

## Catapults and Other Shooting Devices

Catapult activities table top size used for STEM or den activities or pioneering projects less than 5 feet in height are the only approved apparatus. NOTE: contests where the object is to shoot a projectile for great distance are not approved. The potential energy for the catapult should be restricted as appropriate.

Catapults using hydraulic, gas, springs, counterweights, or any other gravity propelled device to provide the propulsion are prohibited. Care should also be taken when determining the number or use of rubber band or bungee cords.

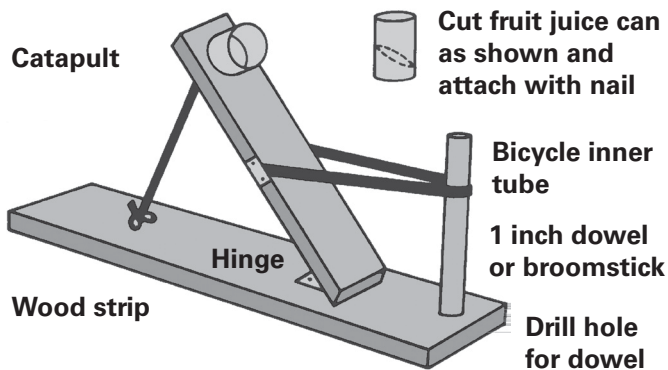

**Table top example above (den meetings/STEM activity)**

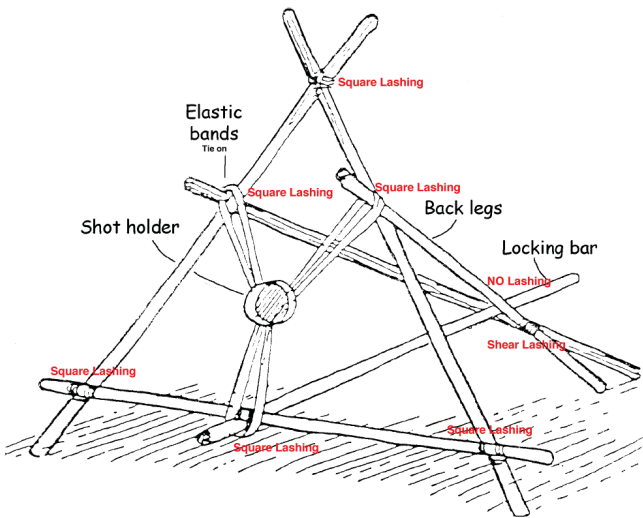

**Catapult shown above made with Scout hiking staff.**

### Ammunition

Water balloons - use small, biodegradable balloons, and fill them no larger than a ping pong ball. Note: When using balloons be sensitive to latex allergies that may be present.

Soft objects - no larger than the opening of a small juice can.

Only soft objects are approved.

The use of any projectile larger than a tennis ball is not approved.

Although specific rules have not been written about each type of shooting activity, these general guidelines apply:

1. Have fun and be responsible!
2. Always wear eye protection.
3. Do not aim any shooting device at a person. Never shoot any projectile, even if it is soft or seems to be harmless, at or near people, animals, or personal property. This includes water balloons.
4. A balloon launcher is not a toy and is made for the sole purpose of launching water balloons. Never launch water balloons at eye level.
5. Do not use any projectiles such as rocks, pebbles, or ball bearings that are hard or that could cause harm.
6. Never use a launcher if there are signs of wear. Check before each use.
7. When using a slingshot or balloon launcher, never put your finger or hand between the tubing connection and the handle.
8. Targets may be made similar to those for archery and BB gun shooting. Creative targets may also be made that relate to the camp theme.
9. The catapults must be launched on range which meets the criteria of a safe range: safe area, safe distance, and safe backstop as appropriate for the size.
10. The range must be established. This can be a temporary area appropriately sized for the activity. Make certain that no one will wander into the landing zone of the projectiles.

### Flash Ball

Flash Ball is a shooting sport for shotgun shooting based on clay pigeon shooting and offers a whole new experience. The throwers used can be easily adjusted to fire a number of varied trajectories. Adding a wider range of targets by using more than one machine makes this already addictive game even more challenging. Targets are filled with white non-toxic powder. When the player hits the target, it flashes, producing the same effect as the flash clays used at the Olympics and other major shooting events.

These programs are approved for use by Scouts BSA, Venturers, and Sea Scouts. Supervision for this activity must follow the guidelines for shotgun shooting.

### Sporting Arrows

These programs are only approved to be conducted at the council or district level camp and must follow the program outline in the appendix. They require a range layout that is larger in size than a standard archery range, as well as an initial financial investment to secure the needed equipment. The traps are stand-alone machines, and the targets are reusable.



To conduct these programs, the council needs to apply via the NCAP annual intent to operate process. The range layouts, standard operating procedures, and qualified supervision requirements are available at <https://www.scouting.org/outdoor-programs/properties/resources/design-guidelines/>.

## Tomahawk Throwing

This is a program for Scouts BSA, Venturers, and Sea Scouts. This program is not approved for Cub Scouts of any rank.

### Overview

The purpose of this document is to give an overview of the sport of tomahawk throwing and how it can be adapted to age-appropriate levels for Scouting.

**The Sport of Tomahawk Throwing.** Tomahawk throwing is increasing in popularity in America. Today, hand-forged tomahawks are made by craftsmen throughout the United States.

**Proper equipment selection and range setup.** A variety of styles and sizes of tomahawks are available today from several manufacturers. Most craftsmen say that heads will last over a decade when properly cared for, and most favor handles made of hickory. Popular tomahawk styles include:

- French or Blackhawk—With handles about 18 inches long, and heads weighing from 12 to 24 ounces, this style of tomahawk is appropriate for all ages.
- A kiddy 'hawk or junior Blackhawk—A good choice for young Scouts, this style measures about 10 to 14 inches long, and its head usually weighs about 8 to 12 ounces.



**Target Styles.** Targets can be made in a variety of styles and from many materials. Following are some suitable options.

- Hay bales—These targets are the cheapest to make and easiest to use. Stack three to make a wall, and attach a paper or painted target.
- Soft wood posts—Logs of pine or other soft wood or repurposed telephone poles make great targets. Dig a 24-inch deep hole, and bury the end so it is stable.
- A-frame stands—Stands can be made from 2 x 4s with ends cut at a 45-degree angle and attached like a tripod at the back. Attach a cross-brace to support the weight of the target. The best target rounds are made of palm trees, and are a minimum of 12 inches in diameter and cut 8 to 10 inches thick. Attach them to the back of the stand using heavy screws.
- H-frame stands or backboard stands—These 2 x 4 frame stands are made of plywood and hardtack to stand up to wear and tear. They can be stabilized or installed permanently by staking them to the ground.
- Target wall—Sink two 2 x 12 posts for each target, and install multiple targets or stations for group activities.



**Range setup.** All ranges must have adequate space and provide participants a clear line of sight. Each range must have a clearly marked perimeter with signage that alerts bystanders of potential danger. The range must have sufficient buffers all around, with 15 to 25 feet on each side and 25 to 50 feet at the rear of the range.

Access to the range should be restricted with a clearly marked gate. The range should have a staging area where safety information and instructions can be shared. Throwing and safety lines should be clearly marked and a minimum of 5 feet from each other. Safety stands or a stack of target rounds on the throwing line can help designate safe observation areas. Each lane should be 5 feet wide to accommodate sufficient throwing space. The distance from the target face to the throwing line is generally 15 feet, but it can be

reduced to 10 feet for younger Scouts. Care should be taken to placethrowers of similar height in lanes beside each other so that a minimum target distance can be achieved with one youth in their throwing lane is not in front of another.

Minimum 6 feet between the throwing line and safety line behind the thrower must be maintained.

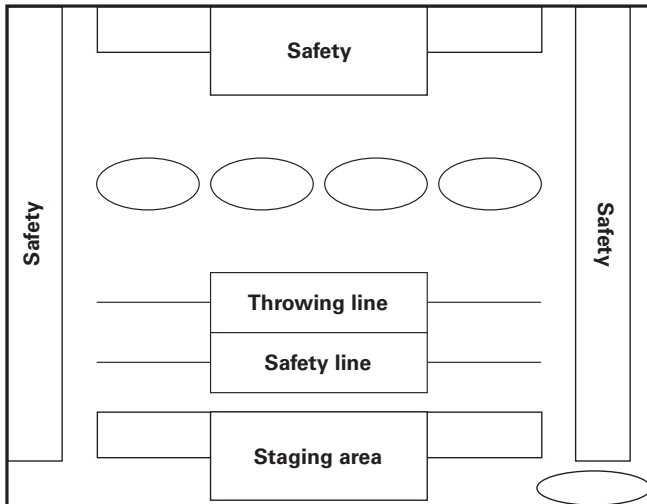

Another option is the multi-target range with the participants in the center facing out and targets set around the perimeter:

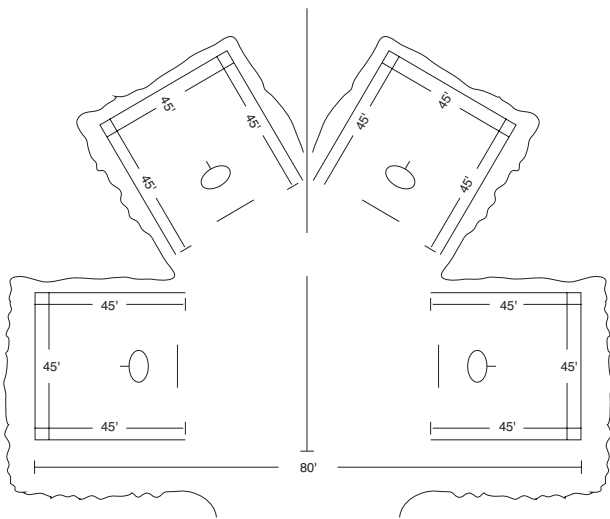

### Range Supervision: Operating the Tomahawk Range

#### Review Range Safety Rules

- Wear hard-toed shoes while on the rangewhenver possible.
- Move to the throwing line when directed to.
- Participants should check the backstop prior to throwing
- Begin throwing when given the command by the range supervisor.
- Only move forward to retrieve hawks when given the command from the range supervisor.

### Sample range commands

#### Range commands

Range commands are to be spoken clearly, loudly, and in the direction of the participants. All participants are to be given a review of the range commands to be used before any throwing can begin.

The following are the basic range commands.

#### 1. Commence Throwing

Gives permission to the group to start throwing

#### 2. Cease Throwing

Tells all participants to stop throwing immediately

#### 3. Range Open

Declares that the range is considered safe to proceed to throwing stage, but does not give permission to throw.

#### 4. Range Closed

Declares the range is closed for throwing. All throwing must cease. This command may be given with or without a preceding or following Cease Throwing command. It is recommended that Cease Throwing command be given in conjunction with the Range Closed command whenever possible.

#### 5. Retrieve your tomahawks

Tells all participants that they may retrieve their tomahawks from the target area. This command must be coordinated with adjacent ranges to ensure that one group is not throwing while another is retrieving.

#### 6. Exit Range

Tells all participants to exit the range

**Stances.** (Described for right-handed throwers; reverse for lefties.)

- Side-by-side stance ( 2 handed throwing - This stance is the safest.)
  - Feet evenly squared with the target
  - Left hand on bottom of handle
  - Right hand on top of left with thumb facing up (helps with rotation)
- Sideways (One handed throwing. This stance is optional; ensure that the draw goes directly overhead and not to the side, which causes the tomahawk to turn.)
  - Body and feet 90 degrees from the target on dominant side
  - Right hand on bottom of handle with thumb facing up
  - Aiming. Site the target with arm extended and tip of 'hawk pointed to desired spot.

## **Throwing**

- Keep elbows and wrists locked.
- Draw tomahawk back over top of head.
- Bring it forward until initial aiming point is reached.
- Release the tomahawk.
- Repeat this process for each ‘hawk in the round.

## **Retrieval.**

- Only when the Range Safety Officer allows, walk to the target—do not run.
- Proper technique to remove tomahawks:
  - Place one hand on the target above the handle, and with the other, firmly grasp the handle of the tomahawk.
  - Push down on the handle, and then pull up on the handle.
  - The tomahawk will release from the target.
- General safety during ‘hawk removal:
  - Always remove the ‘hawk above your head first, and drop it to the ground.
  - If you should stick more than one ‘hawk, keep one hand on each during removal from target.
- Once all ‘hawks have been removed, pick them up, and grasp the head of the ‘hawk in the palm of the hand with blades facing away from the body. (similar to carrying a hand axe)
- Return the ‘hawks to the throwing line with the blades facing downrange.

## **Sticking the Tomahawk**

The key to sticking is consistency, which is most easily attained with a tomahawk of sufficient size and weight. Throw the heaviest tomahawk possible without causing strain. For most people, a head weight of about 16 ounces works well.

Common throwing adjustments that can be made.

A “good stick” is when the handle is about 45 degrees in relation to the surface of the block target. This would appear like the upper corner of the blade forming an acute angle with the top of the head. When this takes place the tomahawk will penetrate deeper and is less likely to fall out.

If the ‘hawk is over rotating or under rotating when thrown the handle will make contact with the target with the ‘hawk handle above or below the ‘hawk head. To correct when this happens the thrower could take a small step forward or back before throwing.

## **Equipment Repair: Replacing Handles and Heads**

If you throw tomahawks, eventually you break handles. As skill improves, breakage occurs less often. Tomahawk replacement handles should meet the manufacturer guidelines of your ‘hawk and must be the correct size and shape for the ‘hawk you are using. For

information about replacement handles see your owner information for your ‘hawk.

Sharpening your tomahawk should be done with a file; using a sharpening stone is advisable but optional. Refer to your owner’s information or the Scouts BSA Handbook as the process is similar to sharpening an ax.

## **Sample Tomahawk Competition Rules**

From the International Knife Throwers Hall of Fame (IKTHOF)

### **For a four-round competition**

#### **Youth ages 16 and over**

Throwers compete in four rounds of three tomahawks from each of five distances, for a total of 60 tomahawks.

Each round consists of 15 tomahawks, three thrown from each distance:

- Three at one spin at a minimum distance of 10 feet
- Three at one and a half spins from a minimum distance of 13 feet
- Three at two spins from a minimum distance of 19.5 feet
- Three at two and a half spins from a minimum distance of 23 feet
- Three at three spins from a minimum distance of 29.5 feet

Maximum 300 points

#### **Youth ages 11–15**

Youth follow the same throwing progressions as adults, but with no minimum distance.

Maximum 300 points

## **Knife Throwing**

This program is for Scouts BSA members, Venturers, and Sea Scouts. This program is not approved for Cub Scouts of any rank.

## **Overview**

The purpose of this document is to give an overview of the sport of knife throwing and how it can be adapted to age-appropriate levels of Scouting.

The following information will help you comply with the standards:

- Proper equipment selection and range setup
- Standard operational procedures (age-appropriate instruction and training)

## ***Proper equipment selection and range setup***

### **Getting the right knife**

Whichever knife you choose, it needs to have certain qualities. Keep the following factors in mind:

- A sharp point (The knife's blade should be dull for safety.)
- Standard thick enough so it will not bend when it lands
- A solid blade to ensure it doesn't break
- Rounded corners
- Handles without excessive ornamentation
- At least 8 inches to a foot in length
- Only knives manufactured for the purpose of throwing are authorized.

**Target Styles.** Targets can be made in a variety of styles and from many materials. Following are some suitable options:

- A-frame stands – Stands can be made from 2x4s with ends cut at 45 degree angle and attached like a tripod to the back. Attach a cross-brace to support the weight of the target.
- H-frame stands or backboard stands – These stands are made of plywood or other similar material to stand up to wear and tear. They can be stabilized or installed permanently by stacking them to the ground.
- Target wall – Sink two 2x12 posts for each target.
- Targets can be a thick piece of pine or other soft wood attached to the frame. The wood should be mounted so the grain is going in a vertical direction. This makes it easier for the knife to stick in the wood.
- Another option for the target is to cut a 18"x18" board and attach layers of cardboard to it with tuck tape. As the target is cut up, you can place additional layers of cardboard over the original.
- **DO NOT TARGET TREES**

**Range setup.** Follow the same setup as listed for tomahawk throwing.

### ***Range supervisor: Running the Knife Throwing***

#### ***Review Range Safety Rules***

- Wear hard-toed shoes while on the range whenever possible.
- Move to the throwing line when directed to.
- Participants should check the backstop prior to throwing.
- Begin throwing when given the command by the range supervisor.
- Only move forward to retrieve knives when given the command from the range supervisor.

## **How to throw a knife**

***Stance (Described for right-handed throwers; reverse for left handed throwers.)***

- Stand up straight and stay relaxed.
- Keep your right foot forward with the left foot slightly behind it.

### ***Grip***

- Grip knives from the handle end.
- **Hammer Grip (1)** – is best for beginners
- **Pinch Grip (2)** – (Commonly used with lighter knives.) Pinch the handle between the thumb and index finger. (*An option is to use two or three fingers opposite the thumb.*)

### ***Throw***

- Grasp the knife.
- Bend your elbow at a 90 degree angle and hold your arm in front of you.
- Move your hand back and up, keeping your eyes on your target.
- When you are comfortable, quickly swing your arm forward and release the knife directly at the target.

### ***Retrieval***

- Only when the range supervisor allows, walk to the target – do not run.
- Place one hand on the target, and with the other, firmly grasp the handle of the knife
- Push down on the handle and lift up. The knife should release from the target.

## ***Sample range commands***

### ***Range commands***

Range commands are to be spoken clearly, loudly, and in the direction of the participants. All participants are to be given a review of the range commands to be used before any throwing can begin.

The following are the basic range commands.

#### **1. Commence Throwing**

Gives permission to the group to start throwing

#### **2. Cease Throwing**

Tells all participants to stop throwing immediately

#### **3. Range Open**

Declares that the range is considered safe to proceed to throwing stage, but does not give permission to throw.

#### **4. Range Closed**

Declares the range is closed for throwing. All throwing must cease. This command may be given with or without a preceding or following Cease

Throwing command. It is recommended that Cease Throwing command be given in conjunction with the Range Closed command whenever possible.

**5. Retrieve your knives**

Tells all participants that they may retrieve their knives from the target area. This command must be coordinated with adjacent ranges to ensure that one group is not throwing while another is retrieving.

**6. Exit Range**

Tells all participants to exit the range



## CHAPTER II: RESOURCES, CERTIFICATES, AND PATCHES

### Resources

Archery Trade Association  
P.O. Box 70  
New Ulm, MN 56073  
866-266-2776  
[www.archerytrade.org](http://www.archerytrade.org)

National Field Archery Association (NFAA)  
800 Archery Lane  
Yankton, SD 57078  
605-260-9279  
[www.nfaa-archery.org](http://www.nfaa-archery.org)

USA Archery  
210 USA Cycling Point, Suite 130  
Colorado Springs, CO 80919  
719-866-4576  
[www.USArchery.org](http://www.USArchery.org)

Daisy Manufacturing Company  
P.O. Box 220  
Rogers, AR 72757-0220  
479-636-1200  
[www.daisy.com](http://www.daisy.com)

Marksman Products  
10652 Bloomfield Ave.  
Santa Fe Springs, CA 90670  
800-822-8005  
[www.marksman.com](http://www.marksman.com)

Crosman Corporation  
7629 Routes 5 and 20  
Bloomfield, NY 14469  
800-724-7486  
[www.crosman.com](http://www.crosman.com)

National Rifle Association (NRA)  
11250 Waples Mill Road  
Fairfax, VA 22030  
800-672-3888  
[www.nra.org](http://www.nra.org)

Tread Lightly!  
800-966-9900  
[www.respectedaccess.org](http://www.respectedaccess.org)





### Sample Archery Scorecard

These cards may be reproduced for campers in the archery program to keep their score as they strive to improve their shooting skill.

Arrow Score			Hits	End Score	Running Score
Total					

Signature

Arrow Score			Hits	End Score	Running Score
Total					

Signature

Arrow Score			Hits	End Score	Running Score
Total					

Signature

Arrow Score			Hits	End Score	Running Score
Total					

Signature

Sample Targets

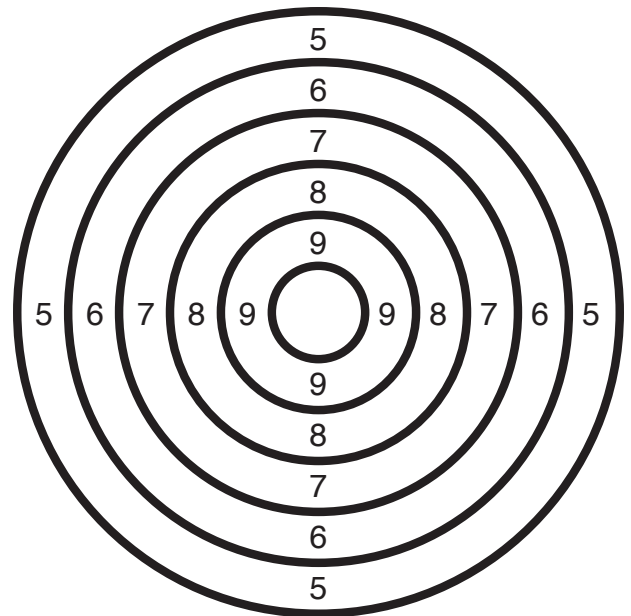
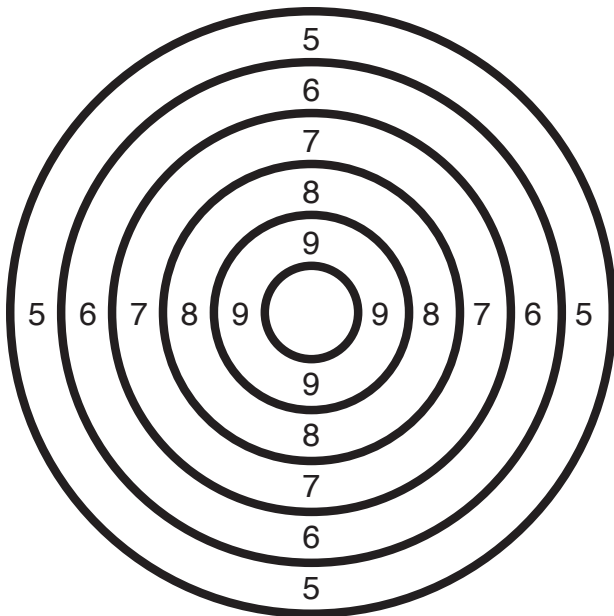
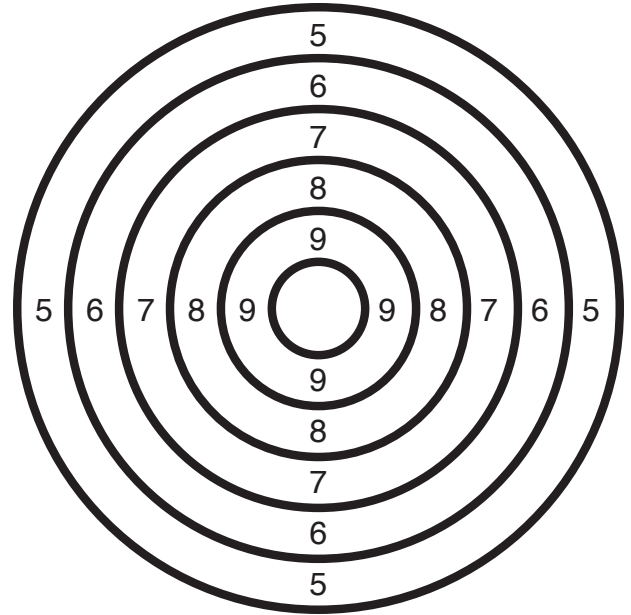
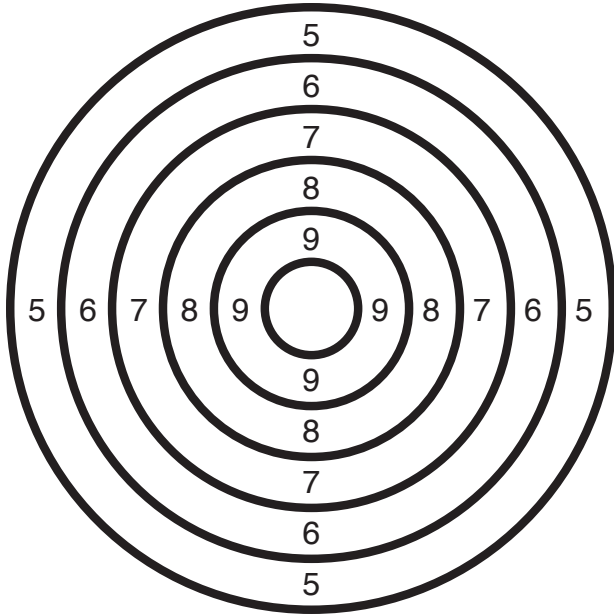

## Crossword Puzzle: Air Gun Shooting

So you think you know a lot about air gunning? Here's a crossword puzzle to test your knowledge of air guns, ammunition, and common shooting terms.

If you find yourself stumped, you can check the answers below.

1. You shoot at this.
2. Your point total.
3. The diameter of a bore determines this.
4. An air gun has none. Kick.
5. Soft lead air gun projectile.
6. Olympic participants strive for this.
7. The inside of the barrel.
8. You catch pellets, BBs, and mice in one of these.

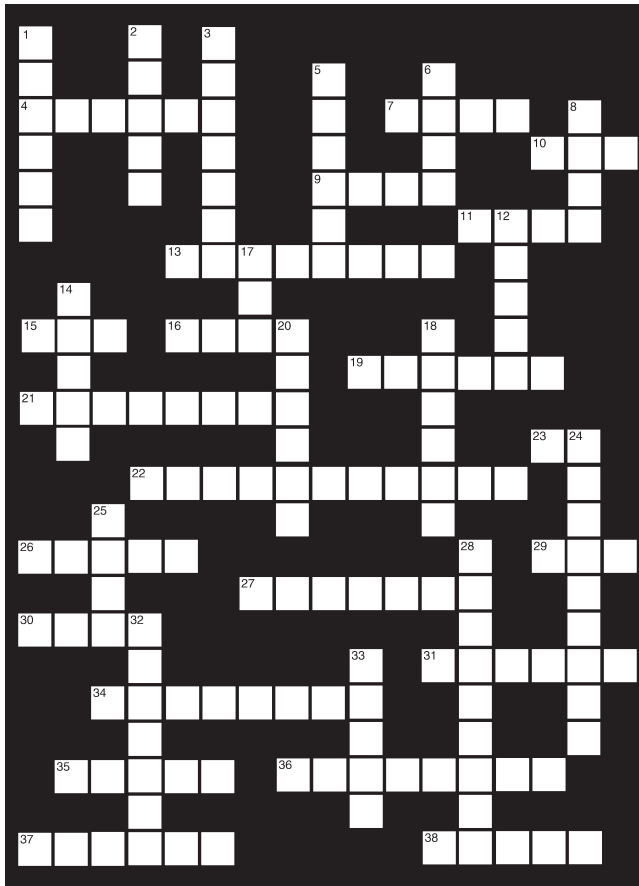

9. You do this when you put pellets or BBs in an air gun's receiver.
10. National Rifle Association.
11. The part by which you hold a pistol.
12. The place where you shoot.
13. Lots of this will make you a better shooter.
14. You hold this type of air gun against your shoulder.
15. The opposite of a miss.
16. A pneumatic air gun requires you to do this to increase air pressure.
17. You do this when you line up the sights on a target.
18. Every shooter's primary responsibility.
19. Handle every gun as if it were this.
20. A hand-held air gun.
21. The highest level of international air gun competition. It takes place every four years.
22. The metal targets that are profiles of rams, turkeys, pigs, and chickens. Use only pellets to shoot them.
23. A perfectly round, copper-covered steel ball fired from some air guns.
24. A new sport that combines the challenges of air gunning and off-road bicycling.
25. This opens a rifle's action.
26. The position air gunners take lying down.
27. The world leader in air gun technology.  
A bikathlon sponsor.
28. This type of air gun is powered by a pump system similar to a bicycle pump.
29. The largest silhouette target.
30. This part of the rifle goes against your shoulder.
31. Always point this in a safe direction. The end of a barrel.
32. Squeeze this to make an air gun fire.
33. The grip, comb, and butt are on this part of a rifle.
34. Never shoot BBs at metallic silhouette targets because they might do this.
35. The aiming device on an air gun.
36. The most important component of an air gun range.
37. The projectile travels from the receiver to the muzzle through this.
38. A telescopic sight.

### Crossword Puzzle Answers

- |            |              |                 |               |              |
|------------|--------------|-----------------|---------------|--------------|
| 1. Target  | 9. Load      | 17. Aim         | 25. Bolt      | 33. Stock    |
| 2. Score   | 10. NRA      | 18. Safety      | 26. Prone     | 34. Ricochet |
| 3. Caliber | 11. Grip     | 19. Loaded      | 27. Crosman   | 35. Sight    |
| 4. Recoil  | 12. Range    | 20. Pistol      | 28. Pneumatic | 36. Backstop |
| 5. Pellet  | 13. Practice | 21. Olympics    | 29. Ram       | 37. Barrel   |
| 6. Gold    | 14. Rifle    | 22. Silhouettes | 30. Butt      | 38. Scope    |
| 7. Bore    | 15. Hit      | 23. BB          | 31. Muzzle    |              |
| 8. Trap    | 16. Pump     | 24. Bikathlon   | 32. Trigger   |              |

# Quiver and Bow Rack

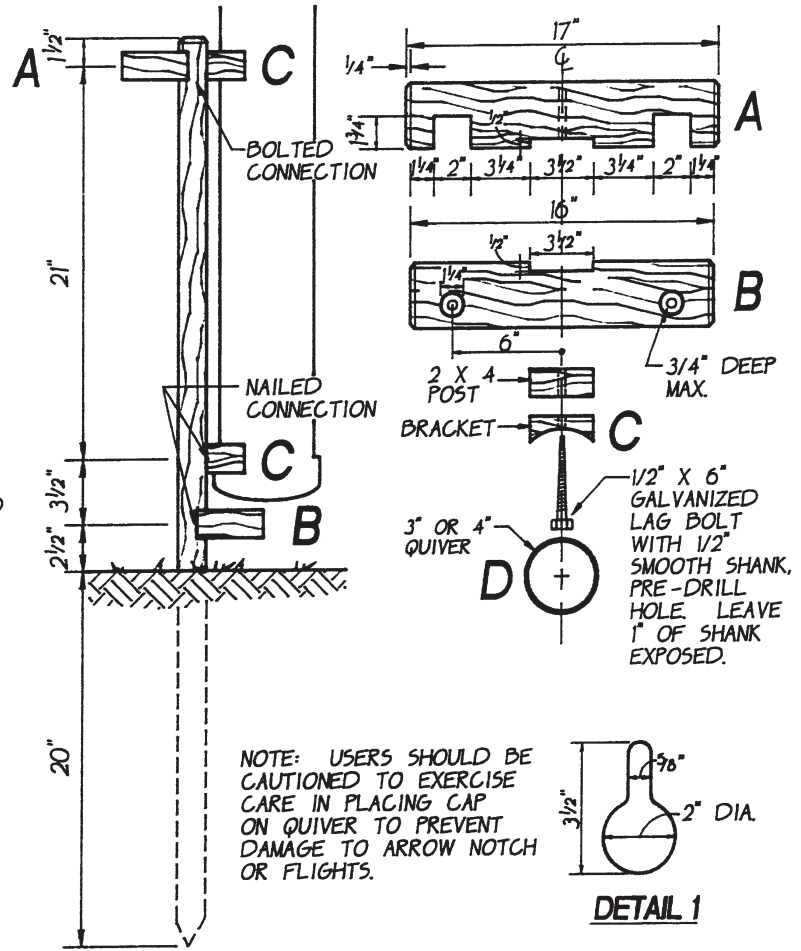
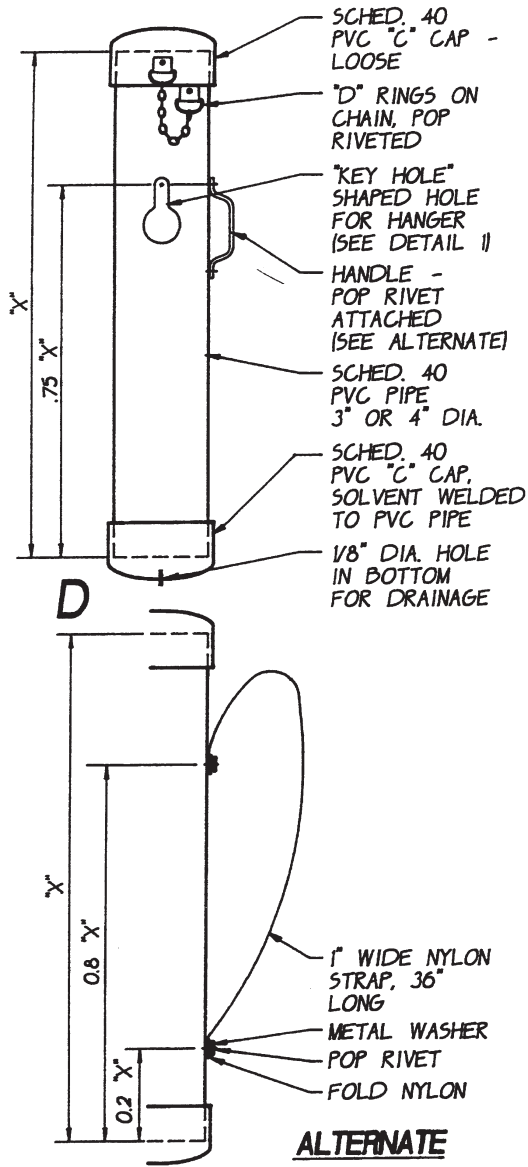

NOTE:  
 $X' = 27"$  FOR 26" LONG ARROW  
 $X' = 29"$  FOR 28" LONG ARROW

Archery Storage Locker

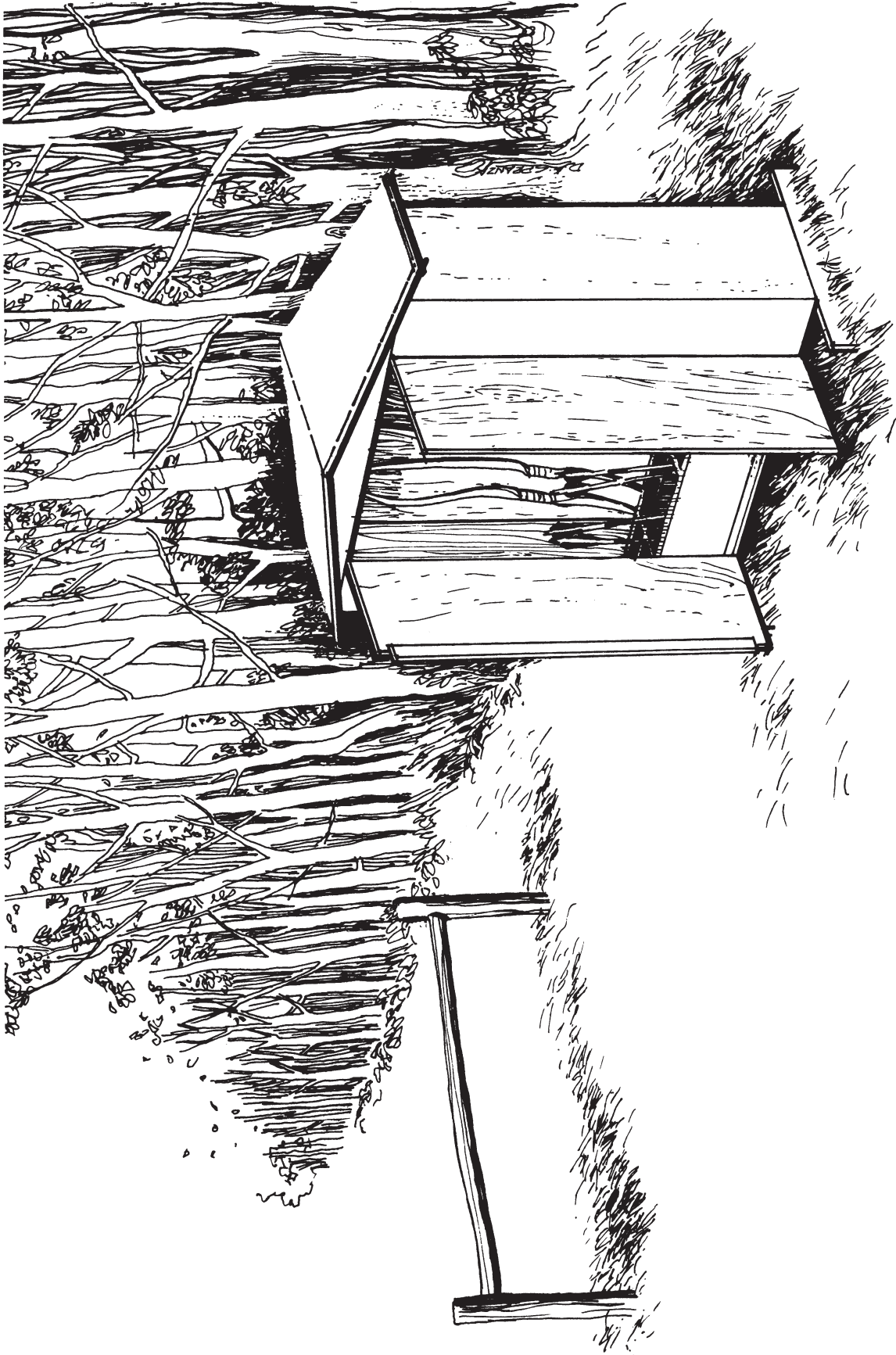

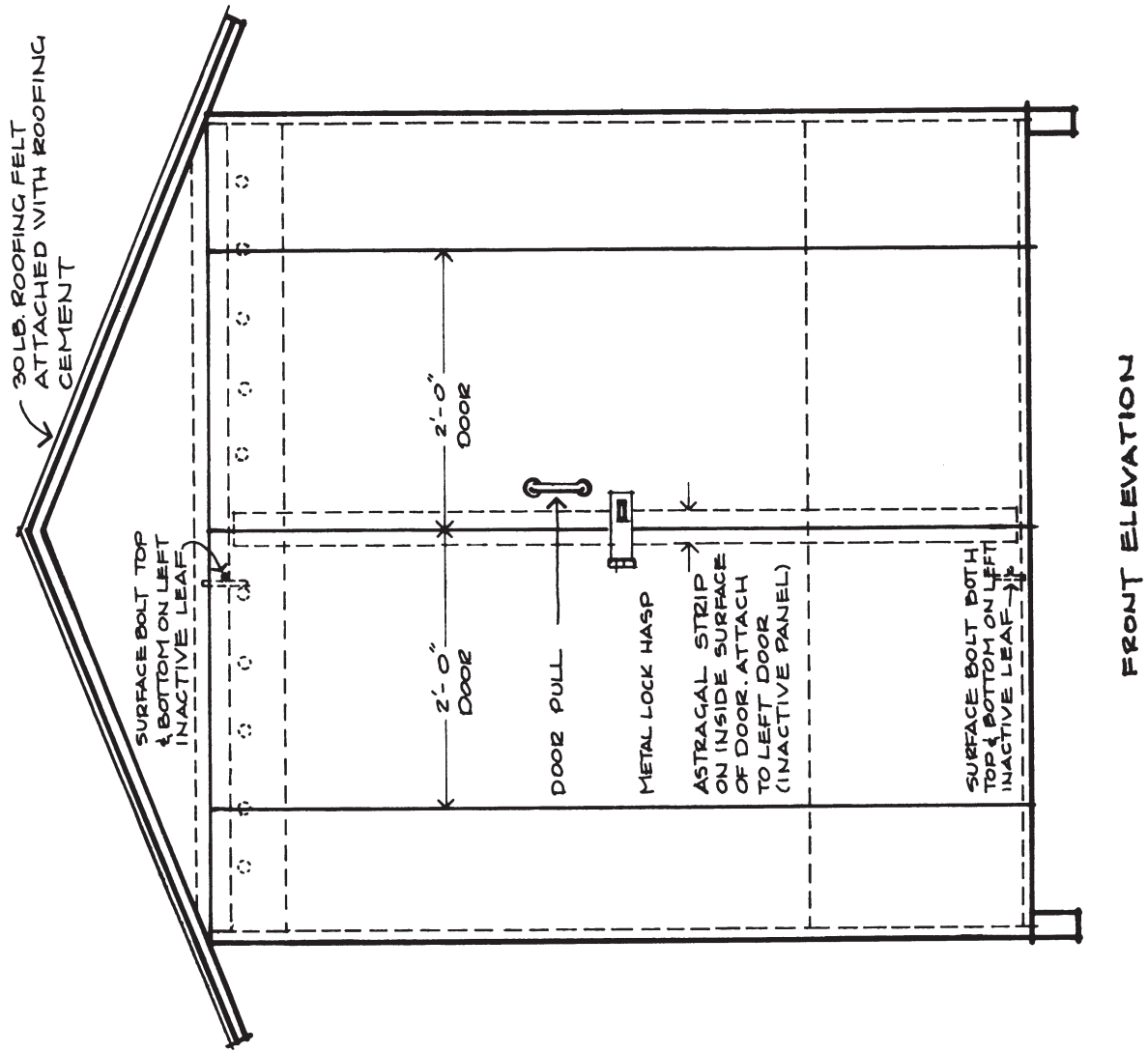
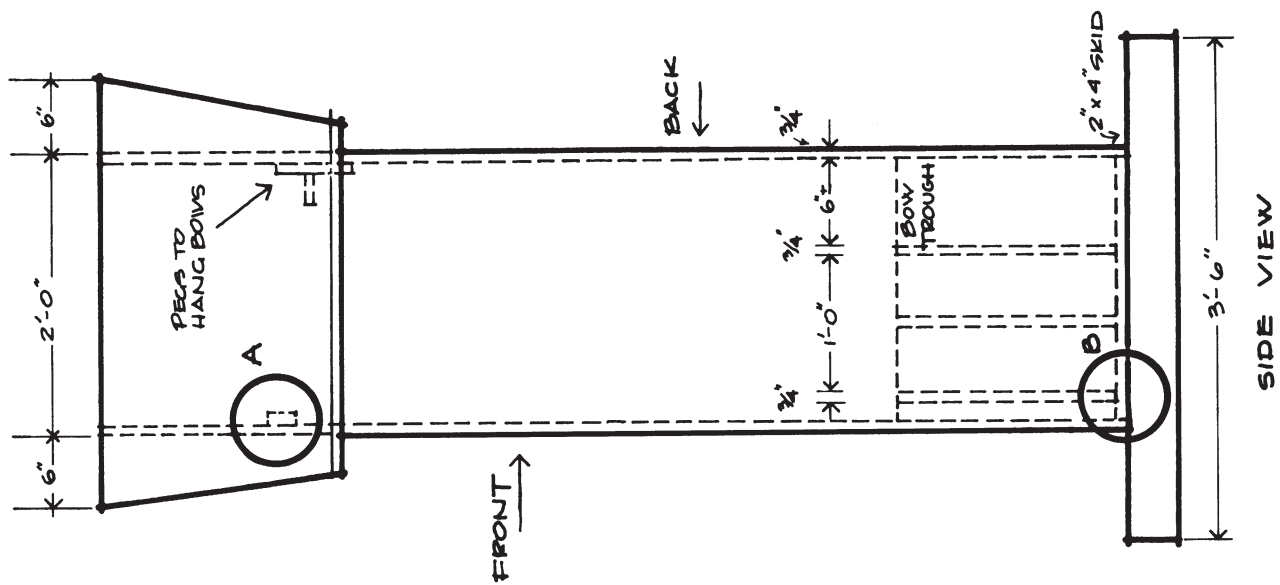



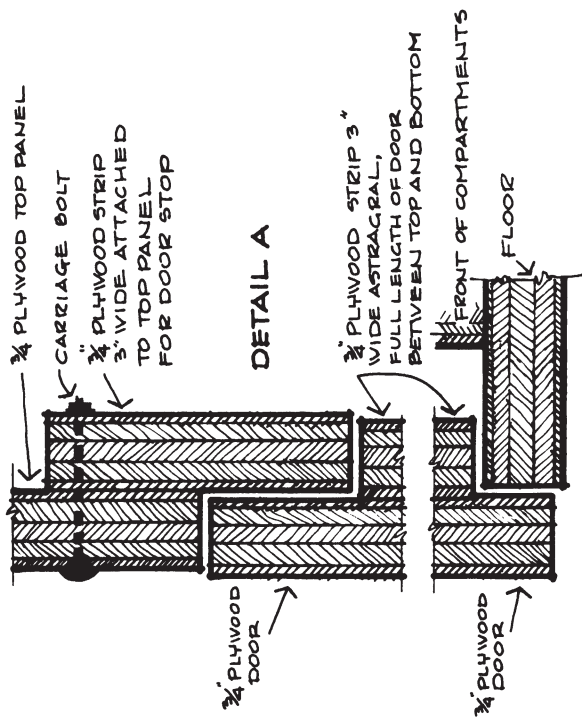

**DETAIL B**

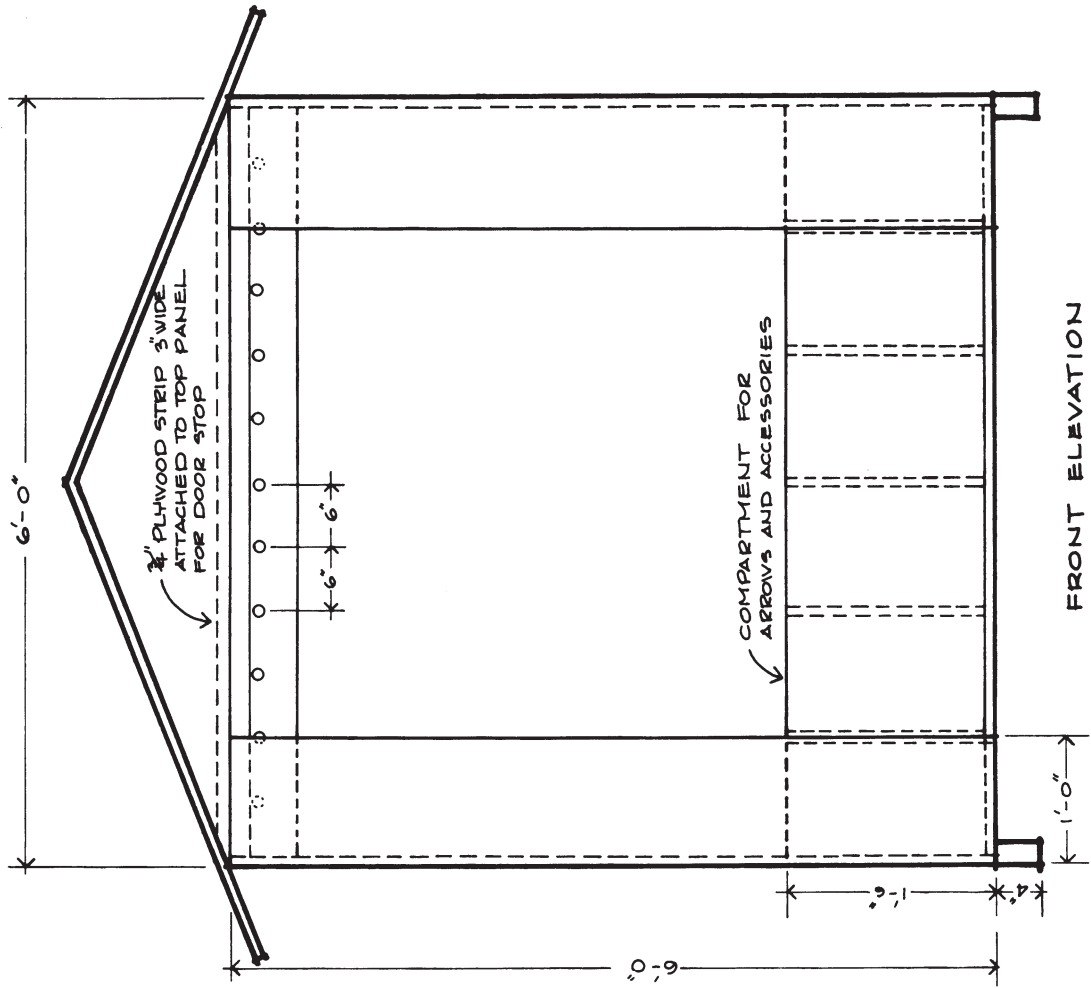
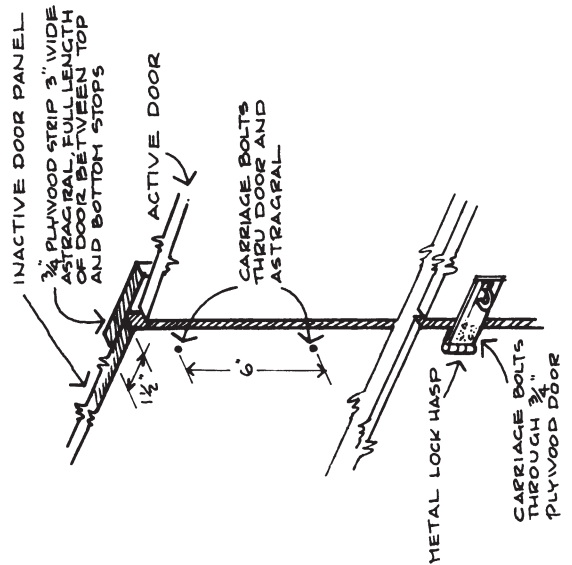

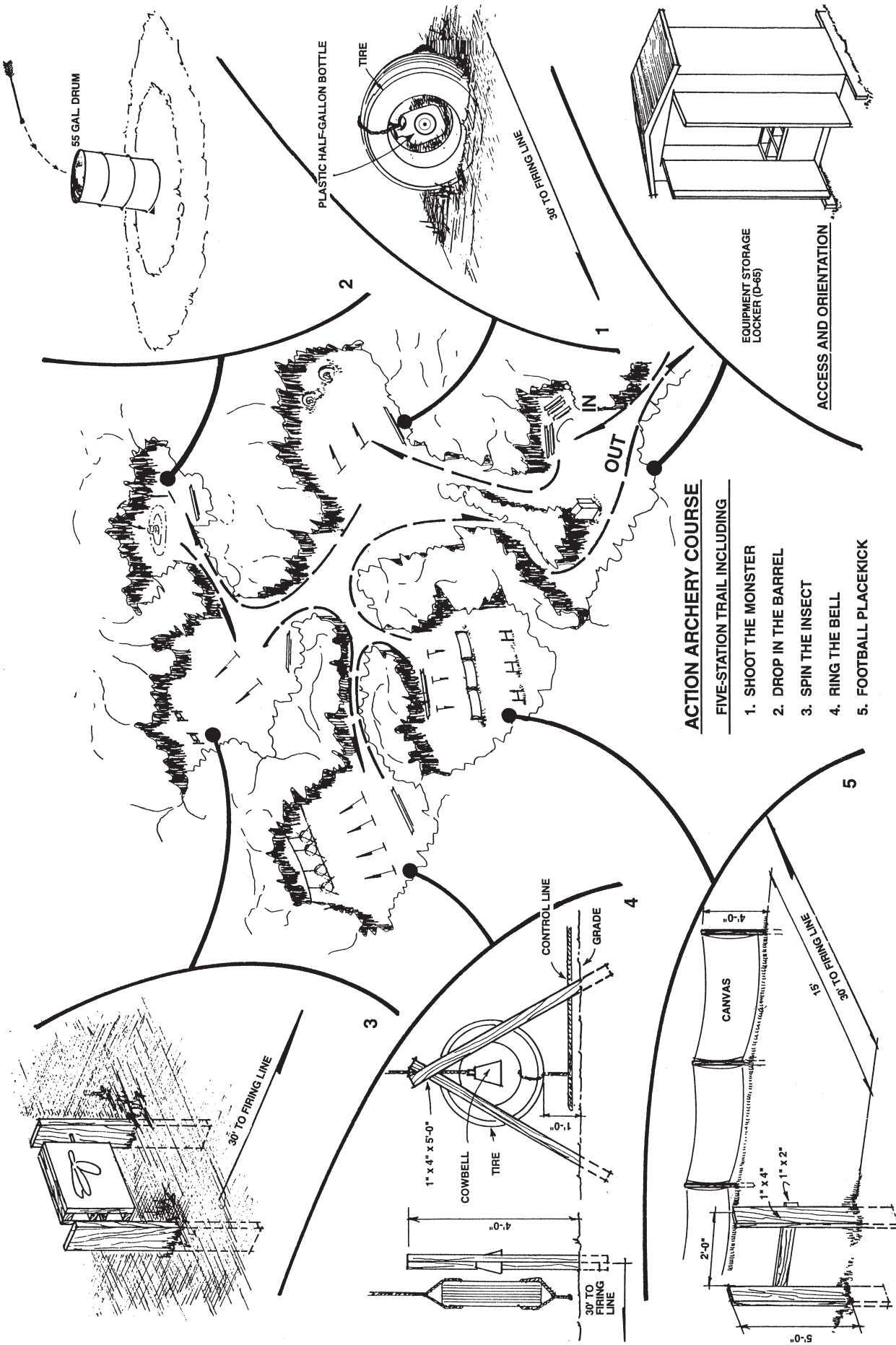

**ACTION ARCHERY COURSE**

**FIVE-STATION TRAIL INCLUDING**

1. SHOOT THE MONSTER
2. DROP IN THE BARREL
3. SPIN THE INSECT
4. RING THE BELL
5. FOOTBALL PLACEKICK

**ACCESS AND ORIENTATION**

EQUIPMENT STORAGE  
LOCKER (D-65)

## Glossary

**action.** A group of moving parts used to cock, compress air (in some models), load, fire, and unload an air gun.

**anchor point.** The particular spot on the archer's face to which the index finger comes on the draw to give consistency to shooting.

**arm guard.** A piece of leather or plastic that is worn on the inside of the forearm to protect the arm from the bowstring.

**arrow plate.** A substance on the side of the bow to give point contact with the arrow.

**arrow rest.** An extraneous device on the bow to provide point contact; also a resting point.

**back.** The side of the bow that is away from the shooter.

**BB.** The term BB is used to describe spherical steel pellets that are .177 inch (4.5 mm) in diameter. However, steel BBs actually have a maximum diameter of .175 inch. BB projectiles for air guns should not be confused with the .181-inch-diameter BB pellets used in shotgun shells.

**blunt.** A blunt-tipped arrow, often used for small game.

**bolt.** A hard, metal projectile with a sharp, pointed nose and plastic fins inserted in the rear portion of the projectile.

**bore.** The inside of the barrel of a gun.

**bow arm.** The arm that holds the bow (not the string).

**bow sight.** A device attached to the bow that allows the shooter to sight directly on the target (which cannot be done with the arrow tip except at point-blank range).

**bowstring.** The string of a bow, usually made of Dacron.

**broadhead.** An arrow with a sharpened metal tip for hunting live game.

**butt.** A backstop for holding arrows shot at a target. The shoulder end of a rifle stock.

**caliber.** The diameter of a projectile, the distance between the lands in a rifled barrel, or the bore diameter in a smoothbore barrel.

**cant.** The act of holding the bow tilted or slightly turned while shooting.

**cast.** The distance a bow can shoot an arrow.

**CO<sub>2</sub> cylinder or tank.** A metal cylinder tank that contains carbon dioxide gas (CO<sub>2</sub>). Available in small disposable cylinders for insertion in some models of CO<sub>2</sub> pneumatic air guns; also available in large tanks that are used to charge refillable cylinders and internal gas reservoirs in other models.

**cocking lever.** The part of a spring-piston air gun used to cock a spring-loaded piston that compresses air at the instant of firing.

**compressed CO<sub>2</sub> /air pneumatic gun.** A type of air gun using carbon dioxide gas (CO<sub>2</sub>) or air that has been compressed and stored in a metal cylinder, or air that is compressed by an external air pump. This type of air gun allows the firing of multiple shots without recharging.

**creeping.** Letting the string hand edge forward before release.

**crest.** Paint or decoration on the arrow shaft near the feathers.

**cylindrical pellets.** A cylindrically shaped air gun pellet that usually has a raised band encircling its base to act as an air seal.

**dart.** A hard metal projectile with a sharp pointed nose and organic or artificial hair or feathers inserted in the rear portion of the projectile.

**dieseling.** The ignition and detonation of low-flash point lubricants due to the high temperature generated during the rapid compression of air in a spring-piston air gun.

**draw.** The acting of pulling the bowstring back into the anchor position.

**drawing arm.** The arm that draws back the bowstring.

**drift.** Natural deflection of an arrow from its normal path due to outside factors, such as wind.

**end.** A specified number of arrows shot at one time (or from one position) before retrieving.

**end loop.** The part of the string that fits over the bow nock.

**face.** The part of the bow facing the shooter; also a target face.

**fast.** An expression used to warn people of arrows being shot.

**field archery.** A competitive round shot at various distances and laid out like a golf course.

**field arrow.** An arrow with a field point; used outdoors for field archery, stump shooting, roving, and small game.

**finger tab.** A tab worn on the drawing hand to protect the fingers and give a smooth release of the bowstring.

**fletching.** The feathers of the arrow that give guidance to the arrow's flight.

**flight.** A competitive round of shooting for distance; also, the path of an arrow.

**forearm.** The part of the arm between the elbow and the wrist.

**free style.** Shooting with the aid of a bow sight.

**front sight.** The sight on the muzzle of a gun.

**glove.** A covering worn to protect the fingers from the string.

**grooves.** The shallow, spiral cuts in a bore that, together with the lands, make up the rifling in the bore of a barrel.

**handle riser.** The center part of the bow.

**head.** The tip or point of the arrow.

**hold.** The act of gripping the bow; hesitating at full draw.

**index.** The raised piece of plastic on the nock of an arrow that is in line with the cock feather.

**index vain.** The arrow feather at right angles to the nock; often of a different color than the other feathers.

**instinctive shooting.** Aiming and shooting arrows instinctively rather than using the pre-gap or point-of-aim methods or a bow sight.

**jerking.** Letting the drawing hand jerk too far back as the arrow is released.

**kick.** The recoil of the bowstring and bow after the arrow is released.

**laminated.** A composite bow, usually of wood and fiberglass.

**lands.** The ridges of metal between the grooves in a rifled barrel.

**limbs.** The two ends of a bow, from the handle riser out.

**longbow.** A bow with no recurve.

**multi-pump pneumatic air gun.** A type of pneumatic air gun that uses several strokes of a lever to compress and store enough air in a reservoir or chamber for one shot.

**muzzle.** The front end of the barrel from which a projectile exits.

**NRA.** National Rifle Association.

**nock.** The groove in the end of the arrow in which the bowstring fits; also, the groove at each end of the bow which holds the bowstring in place.

**nock locator.** The material on the bowstring used to indicate the exact nocking point for the arrow.

**nocking point.** The marked place on the bowstring where the arrow nock is placed before drawing and releasing.

**over-bowed.** Using a bow that is too heavy for the individual.

**overdraw.** Drawing the arrow back too far so that the tip passes the face of the bow. This is a dangerous practice.

**pellet rifle.** A gun that propels a projectile through its barrel by use of compressed air or carbon dioxide gas (CO<sub>2</sub>). Gunpowder is not used in this type of gun.

**plinking.** Informal shooting at a variety of targets.

**pneumatic air gun.** A type of air gun that uses stored compressed air. Divided into two subcategories: single-stroke or multi-pump pneumatics and air pneumatics.

**point.** The tip on the end of the arrow.

**point-blank range.** The only distance from the target at which the point-of-aim is right on the target center.

**point-of-aim.** A method of aiming using a point, usually in front of the target, with which the point of the arrow is aligned; allows for trajectory of the arrow.

**pre-gap (pre-draw gap).** A method of aiming.

**projectile.** A body projected forward such as a bullet from a gun.

**quiver.** A container to hold arrows; can be ground, back, side, or pocket type.

**range officer.** A trained, certified, on-site adult who directs the operation of a range program in a shooting sport.

**rear sight.** The sight nearest the breech of a gun.

**recurve.** A bow that is curved on the ends.

**reflexed bow.** A bow with limb ends curving toward the back rather than toward the face of the bow.

**release.** The act of letting the bowstring slip off the fingertips.

**rifling.** Spiral grooves and lands in the barrel bore that provide a stabilizing spin to a projectile so that it will be more accurate in flight.

**roving.** An outdoor game played by two or more in which natural targets such as stumps, trees, or bushes are selected for accuracy competition.

**self arrow.** An arrow made entirely of one piece of wood.

**self bow.** A bow made entirely of one piece of wood, as opposed to other types of bows such as laminated.

**servicing.** The thread wrapped about the bowstring to prevent fraying of the string.

**shaft.** The middle of an arrow; an unfletched arrow.

**shelf.** The place on the bow where the arrow rests.

**shooting sports director.** The person who has overall responsibility for the operation of the shooting program for council camps and activities.

**sight alignment.** The relationship between the front and rear sights, where the shooter sees that the post bead, disc, or front sight device is aligned properly with the rear sight.

**sights.** Mechanical, optical, or electronic devices used to align the axis of the barrel on the target.

**sinking.** The gradual loss of a bow's power.

**single-stroke pneumatic air gun.** A type of pneumatic air gun that uses one stroke of a lever to compress and store enough air in a reservoir or chamber for one shot.

**small of stock.** The narrow part of a rifle stock.

**smoothbore.** An informal name for a gun that has a smoothbore barrel.

**smoothbore barrel.** A barrel that does not contain rifling.

**solid bow.** A common reference to a bow that is made entirely of fiberglass or plastics.

**spring-piston air gun.** A type of air gun that uses a manually operated lever or other device to cock a spring-loaded piston, which compresses air at the instant of firing. The air that propels the projectile is not stored in a reservoir prior to firing.

**stance.** A standing position assumed when shooting an arrow.

**stock.** The wooden or metal piece to which the barrel or mechanism of a rifle are attached.

**string.** Preparing a bow for shooting; also, the bowstring.

**string fingers.** The three fingers used to draw back the bowstring.

**string height.** The distance between the bow and the bowstring at the handle.

**strung bow.** A bow that is ready to shoot.

**target archery.** A competitive round shot at affixed distances in an open area.

**target arrow.** A lightweight arrow with a target point.

**throwing.** Moving the bow hand to the left upon release.

**understrung.** A bow with a bowstring that is too long.

**vane.** A plastic fletching on an arrow.

**weight.** The amount of effort (in pounds) required to draw the bow a given length (normally measured at 28 inches).

**weight in hand.** The actual weight of the bow.

**windage.** The amount of drift in the flight of an arrow caused by wind.

**wobble.** The erratic motion of a flying arrow.







## APPENDICES

1. NRA FIRST Steps Scouts BSA Shotgun Shooting Merit Badge Teaching Guide
2. NRA FIRST Steps Scouts BSA Rifle Shooting Merit Badge Teaching Guide
3. Sample Standard Operating Procedures Manual
4. Range and Target Activities Decision Tree
5. Cub Scout BB Gun Range and Target Activities
  - Training Archery Rangemasters
  - Training BB Gun Rangemasters
6. Prohibited Activities
7. Open Shooting Archery Experience
8. Instructional Archery Experience
9. Pistol Shooting
10. Multigun Airsoft Experience
11. Chalk Ball Program Guide
12. Cowboy Action Program Guide
13. Instructional Rifle Experience
14. Open Rifle Experience
15. Instructional Shotgun Experience
16. Open Shotgun Experience
17. Sporting Arrows
18. Cub Scout Range and Target Activities Guide
19. Resources



## APPENDIX I

# **NRA FIRST STEPS SHOTGUN INSTRUCTOR'S LESSON PLANS**

## **SCOUTING AMERICA SHOTGUN SHOOTING MERIT BADGE TEACHING GUIDE**

NRA FIRST Steps Firearm Instruction, Responsibility, and Safety Training Program First Edition  
©2017 The National Rifle Association of America

All rights reserved. Printed in the United States of America. This material may not be reproduced in whole or in part, by photocopying, image scanning or by any other means without express written permission. For information, write:  
Training Department, National Rifle Association, 11250 Waples Mill Road, Fairfax, VA 22030



# CONTENTS

Scouting America Introduction .....	94
How to Use This Syllabus.....	94
Consideration for your Merit Badge Class .....	95
NRA <i>FIRST Steps</i> Introduction.....	95
Orientation Outline .....	98
Required NRA Materials.....	98
Lesson 1 Introduction to Shotgun Safety, Parts, and Operation .....	99
Lesson 2 Introduction to Ammunition and the Fundamentals of Shotgun Shooting.....	106
Lesson 3 Introduction to Shotgun Shooting at Straightaway Targets .....	113
Lesson 4 Introduction to Shotgun Cleaning, Storage, and Training Opportunities .....	119

## SCOUTING AMERICA INTRODUCTION

Welcome to the combined NRA Shotgun *FIRST Steps* Instructor syllabus and Scouts BSA Merit Badge Instructor Lesson Plans for the Shotgun Merit Badge. **This teaching plan is to be used by registered adult leaders who are currently certified NRA Shotgun Instructors.**

The purpose of this document is to use a proven standard of instructional curriculum to teach the Shotgun Merit Badge. We have combined the NRA *FIRST Steps* Shotgun Instructor Syllabus with the additions from the requirements necessary to teach the Shotgun Merit Badge into one document and both Scouting America and the NRA have approved this document.

The advantage to using this document is that our youth will receive a consistently safe and proven instructional training no matter where they are trained in any council within the Scouting America family.

By using this syllabus, the registered adult leader or parent who is trained as a NRA Shotgun Instructor is accomplishing two important items.

First and most important, they are delivering a consistent program of responsibility and safe gun handling to our youth. Second, and equally important, they are using the NRA *FIRST Steps* syllabus contained in this document to satisfy the requirements of the NRA to teach a NRA *FIRST Steps* course. By using this syllabus and then registering their merit badge course on the NRA Instructors.org portal, as an NRA *FIRST Steps* course they get credit with the NRA towards accomplishing the goal of qualifying to become a NRA Training Counselor.

The goal of both Scouting America and the NRA is to have at least 2 NRA Training Counselors in every council in the U.S. By doing this we can conduct NRA instructor courses at a cost that most volunteers can afford, thus allowing more leaders the opportunity to become NRA Shotgun Instructors. These instructors will not only be able to conduct merit badge classes, but equally important, they can help provide more year-round shooting sports programs for the unit, district and council.

Thank you for all you do and we look forward to serving you in the future.

## HOW TO USE THIS SYLLABUS

This syllabus contains the NRA *FIRST Steps* program and has been modified by adding a third column to the contents outline along with some Scouting America notes in various places within the document.

If you have never used the NRA *FIRST Steps* Instructor syllabus, the first column tells you what you are going to do, the second column tells you how to do it

or what to say and now the third column tells you what page to turn your merit badge students to and what requirements they will have completed once you do that particular assignment. When teaching the Shotgun Merit Badge use this syllabus as written. Instead of using the NRA Guide: Basic of Shotgun Shooting handbook you will use the Merit Badge book. Each student should have a merit badge book to follow along with the instructional component. When the syllabus says **Ask**, please ask the question, when it says **Explain**, then please explain and when it says **Demonstrate**, please demonstrate. These teaching methods have proven successful with many beginning shooters and your cooperation in following the syllabus will help you in providing a great program to our youth.

The lessons are broken up into 4 days of 1.5 hrs. minimum class time per day. This is the minimum it will take to teach this course properly. Making alterations to the class due to a 1 hr. class 4 or 5 days a week does not accomplish the goals as outlined. This book may not be used if that's the time period you have in your summer camp. Using the 1.5 to 2 hour classes usually provides students ample opportunity for them to complete their required targets during the normal merit badge sessions.

Free time in long term camp was designed for Scouts to have fun and for those not in the merit badge class to have the opportunity to shoot at targets and get a taste of shotgun shooting. Perhaps they may wish to pursue the shotgun merit badge the next time it is available.

The Shotgun Merit Badge may be conducted in an off-season weekend using this syllabus. You just start at the beginning and go all the way thru the syllabus in as little as a full 6 to 8 hr. day.

For more information on how to create successful shotgun programs such as the NRA marksmanship program, please contact your local council range and target activities committee.

The NRA *FIRST Steps* introduction page 9 gives you an idea of what the NRA *FIRST Steps* program delivers to the general public and how it should be used when teaching a non- Scouting America Shotgun Merit Badge student. The Scouting America Course Orientation begins on page 13 and outlines the syllabus by camping days and lesson objectives for each day.

Once again, thank you for all you do for our future shooters.



## CONSIDERATIONS FOR YOUR MERIT BADGE CLASS

### Number of students

- In order to satisfy the Scouts BSA requirements for 50 shots per student in the merit badge class (per merit Badge Requirements) the suggested maximum number of students in class should be **8 Scouts**. This will allow enough time for all students to be successful if you use a 5-day merit badge session with a 1.5 to 2 hr. time block. If you need additional time, then you will need to have students shoot their qualifications during free time on the range.

### Number of traps.

- Location and number of traps is based on student ratio and your range layout.
- Have the trap in the center and far enough in front of the shooting line for safety reasons.

### Number of guns per student

- Number of guns on the line would depend on the guns available and range layout.

### Number of instructors per student

- Consideration should be given to ratios on the range. Scouting America requires a one to one NRA Instructor to student ratio WHILE LOADING AND FIRING.

### Definition of “One to One” while Loading and Firing a Shotgun

- There are four ways to accomplish one to one while loading and firing:
  - Have the NRA Instructor load the gun for the shooter
  - Have the NRA Instructor hand the coach the shell and then the coach can load the shooter’s gun
  - Have the NRA Instructor hand the coach the shell and then the coach can hand the shell to the shooter and the shooter can load the gun himself
  - Have the NRA Instructor hand a shell to the shooter and let the shooter load their own gun
  - There is no policy in Scouting America that requires only the NRA Instructor to load the gun

### NRA Instructor location

- This depends on the range layout

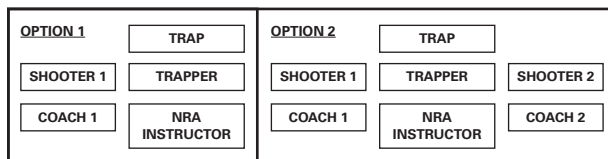

**Option 1** the shooter stands behind and to the left of the trap. The NRA Instructor stands behind the trapper. If you don’t wish to use a trapper to launch the target, then then NRA Instructor may stand behind the trap and next to the shooter.

**Option 2** gives the NRA Instructor the ability to be one on one to shooter one and then rotate to be one on one with shooter two. Again, if you don’t use a trapper then the NRA Instructor would stand behind the trap and in between the two shooters.

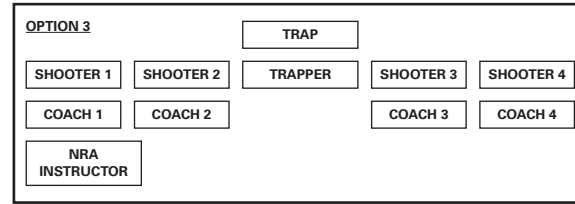

**Option 3** starts the NRA Instructor behind coach one and shooter one. The NRA instructor may only move to shooter two **AFTER SHOOTER ONE FIRES**. Then the NRA Instructor does the same routine with shooter two thru four, always behind whoever has the loaded gun. Remember the NRA Instructor may only have one student at a time loading and firing before the NRA Instructor moves to the next student.

As the shooter who is firing calls for the target the other shooters should either be tracking the target with their finger or, if possible, with an empty shotgun.

## NRA FIRST Steps INTRODUCTION

*FIRST Steps — Firearm Instruction, Responsibility, and Safety Training* — is the National Rifle Association’s response to the American public’s need for a firearm orientation program for new purchasers. New Firearm owners are encouraged to take the “first step” of obtaining training, and the NRA FIRST Steps Program is designed to provide a hands-on introduction to the safe handling and proper orientation of *one specific firearm model*. There are three orientations in the program: one for rifle, one for pistol, and one for shotgun.

Since *FIRST Steps* orientations are model-specific, and teach only the most basic shooting skills, they are not complete “courses” in the traditional sense of the word. They do provide a thorough introduction to firearm safety, handling, and shooting skills. These skills require regular practice. Initially, this practice should take place under the supervision of a qualified individual — like an NRA Certified Instructor or NRA Shooting Coach. For this reason, the orientation encourages participants to obtain additional training in an NRA Basic Firearm Training Course, and then to take the “next step” by participating in other local activities designed to help individuals maintain and develop their shooting skills.

### Total Participant Involvement

The *FIRST Steps* Orientation Program was the first NRA program designed for the new shooter that used the *Total Participant Involvement (TPI)* training methodology. Minimizing the use of lecture, TPI takes an experiential approach that stresses active training

and learning by doing. Instructors guide participants to develop the specified knowledge, skills, and attitude through the use of hands-on exercises and practical applications. Keeping participants involved at every step of the training process engages their energy, holds their interest, and makes learning *fun*! At the same time, the performance-based training approach enables Instructors to evaluate the participants' progress and provide appropriate feedback.

Like the lesson plans for NRA Basic Firearm Training Courses, the *FIRST Steps* lesson plans used a double column format of *content* and *instructional notes*: what to teach and how to teach it. The *FIRST Steps* lesson plans contain far more detail on *how to teach*, and uses **bold print** to indicate directions to the Instructor. Involving participants is stressed throughout the orientation.

One example of involving participants is the NRA policy on how Instructors handle firearms. Each time they pick up a gun, they set the example by practicing the three rules of safe gun handling: making sure the gun is pointed in a safe direction, the finger is off the trigger, and the gun is unloaded. Instructors then involve the participants by having one of them verify that the gun is unloaded.

Another way to involve participants is through the use of the *coach-pupil method*, which has one Instructor, one firearm, and two participants at a shooting station on the range. While one participant (the "pupil") shoots, the Instructor involves the other participant (the "coach") in the learning process by guiding him or her to provide feedback under the Instructor's direction. The Instructor then has the participants reverse roles and repeat the shooting exercise.

The *FIRST Steps* Program is designed for a low participant-to-instructor ratio. The three-hour orientation length is based on a ratio of one-to-one. The length of course lessons will need to be increased proportionately to allow multiple participants to complete all activities specified in the lesson plans. For example, in Lesson I, *each* participant must name the indicated firearm parts, describe their functions, and explain and demonstrate the loading and unloading procedures.

**A single instructor may conduct a *FIRST Steps* orientation for a maximum of four participants at a time in Lessons I, II, and IV, and two participants at a time in Lesson III.**

Instructors may combine students using different shotgun models in the same *FIRST Steps* class, provided that all rifles are of the same action type (all bolt actions, all semi-automatics, etc.). Individual students in such classes are still trained on only their specific model rifle.

As in the case in NRA Basic Firearm Training Courses, Instructors should provide participants with a 10-minute break after every 50 minutes of instruction during a *FIRST Steps* orientation.

These *FIRST Steps* lesson plans should be placed in your *lesson plan* binder and used in conjunction with the *Basics of Shotgun Shooting* handbook.

### **Policy Notes**

*FIRST Steps* orientations can be conducted by NRA Certified Instructors holding credentials in the discipline. They must follow these lesson plans as they pertain to learning objectives, training materials, equipment, orientation content, instructional methodology, and other specified details. Additional policies governing the conduct of the *FIRST Steps* Program will be periodically announced in the *NRA blog and email blasts*, which is sent to all NRA Instructors.

Since the *FIRST Steps* orientations are among the activities that NRA Certified Instructors are authorized to conduct, they will be entered into an instructor's activity record. To ensure that they receive proper credit, instructors must file a completed NRA Firearm Training Course Report Form within ten days of course completion. A separate form must be submitted for each *FIRST Steps* Orientation or Basic Firearm Training Course.

In conducting an NRA *FIRST Steps* orientation, instructors must provide each participant with the items in the *FIRST Steps* Shotgun Participant Packet, and the other items indicated on the "Required NRA Materials" list. The number of participants on an instructor's course report must not exceed the number of participant packets purchased by the Instructor. (Instructors are encouraged to charge a reasonable fee sufficient to recover the costs of materials and other training-related expenses.)

NRA *FIRST Steps* Orientation Completion Certificates are available only as part of the participant packet. The Instructor must indicate on the certificate the model of firearm that was used by the student in the orientation.

The owner's manual for the participant's shotgun should be consulted prior to the orientation to see whether the manufacturer has any particular guidelines for its operation, dry firing recommendations, approved ammunition, and cleaning procedures. Instructors should not conduct the orientation unless they are thoroughly familiar with the correct operation of the participant's shotgun model as recommended by the manufacturer. Instructors who have any questions concerning whether or not the participant's shotgun is safe to shoot should have it checked by a reputable gunsmith before using it in the orientation.

The *FIRST Steps* Program is designed to provide training with one particular firearm model preferably the participant's. However, individuals who do not yet own a firearm may attend a *FIRST Steps* orientation using a firearm provided by the instructor. If an instructor's firearm is used, however, participants should be advised that the operational and handling characteristics will not be the same on a different firearm. They should be

encouraged to attend a new *FIRST Steps* orientation if they later purchase a different gun.

**No live ammunition is permitted in the classroom under any circumstances, or on the range during Lessons I, and IV if these lessons are conducted on a range. Dummy ammunition must be visually distinguishable from live ammunition to ensure that a live round is not brought to class, or to the range except during Lesson III.**

NRA Instructors may refer to guns as “firearms,” “guns,” “shotguns,” etc. but not as “weapons.” “Weapon” has a negative connotation.

Establish emergency procedures to be followed in the event of an accident. All course staff must be aware of these procedures and maintain a list of emergency telephone numbers.

### **Good Luck!**

Remember, the *FIRST Steps* Program was designed with both the instructor and the participant in mind. These lesson plans will prepare you to conduct a successful orientation, and provide your participants with an exciting and informative introduction to the world of shooting.

We thank you for your commitment to firearm education and your participation in the training programs of the National Rifle Association. Your expertise and dedication will train a new generation of American shooters to exercise their firearm freedoms safely and responsibly. If you have any questions about *FIRST Steps* or the NRA Basic Firearm Training Program, please contact the NRA Training Department, 11250 Waples Mill Road, Fairfax, VA 22030, (703) 267-1500.

NRA Training Department  
Education & Training Division  
October 2017

### **Special Thanks**

This program was made possible, in part, thanks to a grant from The NRA Foundation and its generous donors.

The NRA Foundation 11250 Waples Mill Road Fairfax,  
VA 22030 1-800-423-6894

[www.nrafoundation.org](http://www.nrafoundation.org)  
[nraf@nrahq.org](mailto:nraf@nrahq.org)

## ORIENTATION OUTLINE

### NRA *FIRST Steps* Shotgun Orientation

**Orientation Goal:** To provide beginning shooters with an introduction to the knowledge, skills, and attitude necessary to own and use a specific shotgun model safely.

**Length of Orientation:** 3 hours. (All times listed are minimums. Additional time may be needed to meet the specified learning objectives using the methodology of Total Participant Involvement.)

**Note:** Use the Merit Badge Book instead of the NRA Guide: *Basics of Shotgun Shooting* handbook. Lesson times are noted.

Lesson time must be increased proportionately to allow multiple participants to complete all specified activities.)

**Participant Text:** NRA Guide: *Basics of Shotgun Shooting* handbook.

#### Orientation Lessons:

Lesson I: Introduction to Shotgun Safety, Parts, and Operation (45 minutes)

Lesson II: Introduction to Ammunition and the Fundamentals of Shotgun Shooting (45 minutes)

Lesson III: Introduction to Shotgun Shooting at Straightaway Targets (60 minutes)

Lesson IV: Introduction to Shotgun Cleaning, Storage, and Training Opportunities (30 minutes)

**SCOUTS BSA:** Your attached lesson plans will be taught for a minimum of 1.5 hrs. each day for 4 to 5 days for a total of 6 to 8 hrs. Teaching 1 hr. classes will not fit this syllabus. Please see the time adjustments below for covering the Scouting America Merit Badge.

#### Orientation Lessons:

Lesson I: Introduction to Shotgun Safety, Parts, and Operation  
**Note: Teach this lesson on Day 1 for 1.5 hrs. (See syllabus)**

Lesson II: Introduction to Ammunition and the Fundamentals of Shotgun Shooting  
**Note: Teach this lesson on Day 2 for 1.5 hrs. (See syllabus)**

Lesson III: Introduction to Shotgun Shooting at Straightaway Targets  
**Note: Teach this lesson on Day 3 for 1.5 hrs. (See syllabus)**

Lesson IV: Introduction to Shotgun Cleaning, Storage, and Training Opportunities  
**Note: Teach this lesson on Day 4 for 1.5 hrs. (See syllabus)**

## REQUIRED NRA MATERIALS

### NRA *FIRST Steps* Shotgun Orientation

(See current <https://materials.nrahq.org> for item numbers and prices)

**Note:** This list does not apply to Scouting America merit badge classes. You only need this list if you are doing a regular NRA *FIRST Steps* class.

#### One per participant:

- NRA *FIRST Steps* Shotgun Participant Packet - contains the following items:
- NRA Guide: *Basics of Shotgun Shooting* handbook
- NRA Gun Safety Rules card
- NRA *FIRST Steps* Shotgun Orientation Completion Certificate
- NRA Basic Training Program brochure
- NRA Marksmanship Qualification Program booklet

**Note:** Anytime you see the NRA Guide: *Basics of Shotgun Shooting* handbook as the reference use the Shotgun Merit Badge Book instead

#### For reference:

NRA Guide: *Basics of Shotgun Shooting* handbook

## OTHER REQUIRED EQUIPMENT

Shotgun

Shotgun owner's manual

Dummy ammunition (must be visually distinguishable from live ammunition)

Empty shotshell box for shotgun model used

Fired shotshell case for model used

Flashlight

Quality factory ammunition (for use during live fire exercises on range only)

Hearing protection

Eye protection

Trap

Targets

Shotgun cleaning equipment

Lockable shotgun case

## LESSON I. Introduction to Shotgun Safety, Parts, and Operation

**Note:** Lesson I is taught on Day 1 each week of camp

**LEARNING OBJECTIVES:** As a result of their participation in this training session, participants will be able to:

1. State the goal of the NRA *FIRST Steps* Shotgun Orientation.
2. Name the three fundamental NRA rules of safe gun handling and demonstrate them with a specific shotgun model.
3. Name the three major components of a shotgun and describe their functions.
4. Safely demonstrate the loading and unloading procedures for a specific shotgun model with dummy ammunition.

**LENGTH:** 45 minutes

**FACILITY:** Classroom or Range

- **TRAINING AIDS:** Shotgun, shotgun owner's manual, dummy ammunition, one per participant of the following: NRA Training Course Student Registration Card, NRA Guide: *Basics of Shotgun Shooting* handbook, *NRA Gun Safety Rules card*

**(Note: No live ammunition is to be used during this lesson. Dummy ammunition must be visually distinguishable from live ammunition.)**

**REFERENCES:** NRA Guide: *Basics of Shotgun Shooting* handbook.

**Note:** Anytime you see the NRA Guide: *Basics of Shotgun Shooting* handbook as the reference use the Shotgun Merit Badge Book instead

<b>Content</b>	<b>INSTRUCTIONAL NOTES</b> <b>Lesson Time: 10 min. max</b>	
<b>A. Orientation</b>		
1. Registration	1. <b>Instruct</b> participants to fill out an NRA Training Course Student Registration Card	<b>Note:</b> Have Scouts fill out their merit badge card
2. Welcome	2. <b>Introduce</b> self and welcome participants to the orientation	
3. Orientation goal	3. <b>Review</b> the orientation goal with participants: <i>To provide beginning shooters with an introduction to the knowledge, skills, and attitude necessary to own and use a specific shotgun model safely.</i>	
4. Orientation schedule	4. <b>Review</b> the orientation content, and the times and locations of the different lessons of the orientation.	Items 1-10 in column 1 should only take 5 minutes to do
5. Special considerations	5. <b>Review</b> any special considerations that are unique to the orientation, e.g., transportation arrangements to range facility.	
6. Facilities	6. <b>Point out</b> location of rest rooms, drinking fountain, telephone, first aid kit, fire exits, alarm, extinguishers, etc.	Explain the merit badge schedule for the week
7. Firearms	7. <b>Check</b> immediately any firearms to be used during the orientation to insure they are unloaded, and <b>have a participant verify</b> this.	



<p>8. No live ammunition in classroom</p> <p>9. Gun fit</p> <p>10. Basic handbooks</p>	<p>8. <b>Note</b> that no live ammunition is permitted in the classroom, and that <u>only</u> dummy ammunition will be used during the first two lessons of the orientation. <b>Check</b> with participants to be sure they have not brought any live ammunition into the classroom.</p> <p>9. <b>Check</b> the fit of the shotgun to be used during this orientation relative to the size and strength of the participants. The participant should be able to hold the shotgun securely and comfortably, mount it correctly, and reach and operate the appropriate parts safely and properly.</p> <p>10. <b>Distribute</b> the NRA Guide: <i>Basics of Shotgun Shooting</i> handbooks to participants. <b>Note</b> that the handbook will be used during the orientation, and may be used afterwards as a reference to review the material covered in class.</p> <p style="text-align: center;"><b>Lesson Time: 5 min. max</b></p>	<p>Distribute the merit badge books to Scouts</p>
<p><b>B. Introduce Lesson</b></p>	<p><b>State</b> learning objectives for this lesson.(just state 4 objectives from lesson 1 page 1) Do not go into any detail on this)</p> <p style="text-align: center;"><b>Lesson Time: 20 min. max</b></p>	
<p><b>C. Shotgun Safety</b></p> <p>1. The importance of safety</p> <p>2. The major causes of gun accidents</p> <p>3. The fundamental NRA rules for safe gun handling</p> <p>a) <u>ALWAYS</u> keep the gun pointed in a safe direction.</p>	<p>1. <b>Ask</b> participants: What do you think is our primary concern when handling firearms? <b>Discuss</b> responses briefly. State that <u>safety</u> is always the primary concern when handling firearms, whether the guns are located in the home, at the range or in the field.</p> <p>2. <b>Ask</b> participants: What do you think are the major causes of gun accidents? <b>Discuss</b> responses briefly. <b>State</b> that <u>ignorance</u> and <u>carelessness</u> are the primary causes: a lack of knowledge of firearm safety or operation (ignorance), or the failure to apply one’s knowledge when handling guns (carelessness).</p> <p>3. <b>Distribute</b> the <i>NRA Gun Safety Rules</i> card to participants. <b>Explain</b> that the NRA has developed three basic rules which should always be applied simultaneously when handling or using a gun.</p> <p>a) <b>Turn</b> with participants to the three rules in the brochure. <b>Have participants read</b> the first rule aloud. <b>Ask:</b> What do you think is meant by a “safe direction”? <b>Discuss</b> responses briefly. <b>Explain</b> that this rule means that a gun must always be pointed so that even if it were to discharge, it would not cause injury or damage. <b>Note</b> that controlling the gun’s <u>muzzle</u> is the key, and that common sense will dictate the safest direction. <b>Indicate</b> the safe direction(s) in the facility you are using.</p>	<p><b>Note:</b> Refer Scouts to pg. 23-24 in MB Book</p> <p>Step 3 qualifies for teaching req. 2b</p>



<p>b) <u>ALWAYS</u> keep your finger off the trigger until ready to shoot.</p> <p><b>C. Shotgun Safety</b></p> <p>1. The importance of safety</p> <p>2. The major causes of gun accidents</p> <p>3. The fundamental NRA rules for safe gun handling</p> <p>a) <u>ALWAYS</u> keep the gun pointed in a safe direction.</p>	<p><b>Demonstrate</b> this rule by <b>picking up</b> a shotgun, <b>identifying</b> the muzzle, and <b>noting</b> that you have it pointed in a safe direction.</p> <p>b. <b>Have participants read</b> the second rule aloud. <b>Ask:</b> If your finger is kept off the trigger, where should it be? <b>Discuss</b> responses briefly. <b>Explain</b> that the finger should rest outside the <u>trigger guard</u> or along the side of the gun.</p> <p><b>Demonstrate</b> this rule by <b>identifying</b> the trigger and trigger guard on the shotgun you are holding, and <b>noting</b> that you are holding the gun with your finger off the trigger, while keeping the gun pointed in a safe direction.</p> <p style="text-align: center;"><b>Lesson Time: 20 min. max</b></p> <p>1. <b>Ask</b> participants: What do you think is our primary concern when handling firearms? <b>Discuss</b> responses briefly. State that <u>safety</u> is always the primary concern when handling firearms, whether the guns are located in the home, at the range or in the field.</p> <p>2. <b>Ask</b> participants: What do you think are the major causes of gun accidents? <b>Discuss</b> responses briefly. <b>State</b> that <u>ignorance</u> and <u>carelessness</u> are the primary causes: a lack of knowledge of firearm safety or operation (ignorance), or the failure to apply one's knowledge when handling guns (carelessness).</p> <p>3. <b>Distribute</b> the <i>NRA Gun Safety Rules</i> card to participants. <b>Explain</b> that the NRA has developed three basic rules which should always be applied simultaneously when handling or using a gun.</p> <p>a) <b>Turn</b> with participants to the three rules in the brochure. <b>Have participants read</b> the first rule aloud. <b>Ask:</b> What do you think is meant by a "safe direction"? <b>Discuss</b> responses briefly. <b>Explain</b> that this rule means that a gun must always be pointed so that even if it were to discharge, it would not cause injury or damage. <b>Note</b> that controlling the gun's <u>muzzle</u> is the key, and that common sense will dictate the safest direction. <b>Indicate</b> the safe direction(s) in the facility you are using.</p> <p><b>Demonstrate</b> this rule by <b>picking up</b> a shotgun, <b>identifying</b> the muzzle, and <b>noting</b> that you have it pointed in a safe direction.</p>	<p><b>Note:</b> Refer Scouts to pg. 23-24 in MB Book</p> <p>Step 3 qualifies for teaching req. 2b</p>
---	--	---

<p>b) <u>ALWAYS</u> keep your finger off the trigger until ready to shoot.</p> <p>c) <u>ALWAYS</u> keep the gun unloaded until ready to use.</p>	<p>b. <b>Have participants read</b> the second rule aloud. <b>Ask:</b> If your finger is kept off the trigger, where should it be? <b>Discuss</b> responses briefly. <b>Explain</b> that the finger should rest outside the <u>trigger guard</u> or along the side of the gun.</p> <p><b>Demonstrate</b> this rule by <b>identifying</b> the trigger and trigger guard on the shotgun you are holding, and <b>noting</b> that you are holding the gun with your finger off the trigger, while keeping the gun pointed in a safe direction.</p> <p>c. <b>Have participants read</b> the third rule aloud. <b>Ask:</b> How do you know whether or not a gun is unloaded? <b>Discuss</b> responses briefly. <b>Explain</b> that you check whether a gun is unloaded by opening the <u>action</u>, and visually inspecting the <u>chamber(s)</u>.</p> <p><b>Demonstrate</b> this rule by <b>identifying</b> the action, and chamber(s) on the shotgun you are holding, and <b>noting</b> that the action open, and the chamber(s) empty. <b>Have a participant verify</b> that the gun is unloaded.</p>	
--	---	--

**Note:** The requirements listed below are not found in the *FIRST Steps Shotgun Lesson Plan*.

Teach these requirements prior to continuing with the *FIRST Steps Shotgun Lesson Plan* to Paragraph D *Safe Shotgun Handling Practical Exercise* listed below.

**Scouting requirement 1a**

Explain why BB and pellet air guns must always be treated with the same respect as firearms. Refer Scouts to *Shotgun Shooting Merit Badge Book* page 25, “BB and Pellet Air Guns.”

**Scouting requirement 2Aj**

Selecting a shotgun. Refer Scouts to *Shotgun Shooting Merit Badge Book* page 46-49

<p><b>Content</b></p> <p><b>D. Safe Shotgun Handling Practical Exercise</b></p>	<p style="text-align: center;"><b>INSTRUCTIONAL NOTES</b></p> <p style="text-align: center;"><b>Lesson Time: 15 min. max</b></p> <p><b>D. Note</b> that, when handing a firearm to another person, the three rules of gun safety must be observed simultaneously, i.e., gun pointed in a safe direction, finger off the trigger, magazine out, action open, and empty chamber(s) visible.</p> <p><b>Note</b> also that a gun should not be accepted from another person unless its magazine is out, its action open, and its empty chamber(s) visible.</p> <p><b>Hand</b> the shotgun you are using in this orientation to one participant at a time.</p> <p><b>Have participants demonstrate</b> the three safety rules while handling the shotgun.</p> <p><b>Have participants describe</b> each action they perform, i.e., that they are keeping the gun pointed in a safe direction, etc. The shotgun’s action must remain open during this exercise, and must not be manipulated by participants at this time.</p> <p><b>Have each participant hand</b> the shotgun back to you when they are done.</p> <p><b>Offer</b> guidance, direction, encouragement, and positive feedback as appropriate.</p>	<p><b>Note:</b> Refer Scouts to pg. 23 and 24 in MB Book</p> <p>Step D qualifies for teaching req. 2b</p>
---	--	---

<p><b>E. Shotgun Parts: Major Components</b></p> <p>1. Stock</p> <p>2. Barrel</p> <p>3. Action</p>	<p style="text-align: center;"><b>Lesson Time: 5 min. max</b></p> <p><b>E. Note</b> that all shotguns consist of three major components: the <u>stock</u>, the <u>barrel</u>, and the <u>action</u>.</p> <p>1. <b>Turn</b> with participants to the definition of the <u>stock</u> in the NRA Guide: <i>Basics of Shotgun Shooting</i> handbook. <b>Have participants read</b> the definition aloud. <b>Point out</b> the stock on the shotgun you are using.</p> <p>2. <b>Turn</b> with participants to the definition of the <u>barrel</u> in the NRA Guide: <i>Basics of Shotgun Shooting</i> handbook. <b>Have participants read</b> the definition aloud. <b>Point out</b> the barrel on the shotgun you are using.</p> <p>3. <b>Turn</b> with participants to the definition of the <u>action</u> in the NRA Guide: <i>Basics of Shotgun Shooting</i> handbook. <b>Have participants read</b> the definition aloud. <b>Point out</b> the action on the shotgun you are using.</p>	<p>Refer Scouts to pg. 23-24 in MB Book</p> <p>Step E qualifies for teaching req. 2a</p> <p>Refer Scouts to pg. 14-16 in MB Book</p> <p>Fills MB Req. 2Aa</p>
<p><b>F. Shotgun Parts:</b></p> <p>1. Stock</p> <p>a. Butt — the rear portion of the stock which is designed to fit against the shoulder.</p> <p>b. Comb — the top portion of the stock, on which the shooter rests the cheek.</p> <p>c. Grip — the area where the hand grasps the stock when firing the shotgun</p> <p>d. Fore-end (or forearm) — the part of the stock that extends underneath the barrel. This is where the non-shooting hand holds the shotgun to support it. When separate from the rest of the stock, it is called the forearm.</p> <p>2. Barrel</p> <p>a. Bore — the inside of the barrel. The diameter of the bore is designated by the term <u>gauge</u>. The smaller the gauge number, the larger the bore diameter.</p>	<p style="text-align: center;"><b>Lesson Time: 10 min. max</b></p> <p>1. <b>Review</b> with participants the definition of the <u>stock</u> by asking them to define it.</p> <p><b>Name</b> the shotgun parts listed at left, <b>point out</b> their location on the <u>stock</u> of the shotgun you are using, and <b>describe</b> briefly the function of each part.</p> <p><b>Review</b> the parts of the <u>stock</u>. <b>Point</b> to each part, <b>have participants name</b> each one, and <b>have participants describe</b> briefly the function of each part.</p> <p>2. <b>Review</b> with participants the definition of the <u>barrel</u> by asking them to define it.</p> <p><b>Name</b> the shotgun parts listed at left, <b>point out</b> their location on the <u>barrel</u> of the shotgun you are using and describe briefly the function of each part.</p>	<p>Refer Scouts to pg. 10-14 in MB Book</p>

<p>b. Breech — the rear of the barrel.</p> <p>c. Chamber — the part of the barrel, located at the breech end, which holds the shotshell at the instant of firing.</p> <p>d. Muzzle — the front end of the barrel where the shot pellets exit.</p> <p>e. Choke — a constriction in the bore near the muzzle. The choke influences how the shot pellets will spread after leaving the barrel.</p> <p>f. Bead (s) — mechanism used to help the shooter mount and point the shotgun</p> <p>3. Action</p> <p>a. Receiver — the backbone to which all other parts are attached.</p> <p>b. Bolt/breech block — closes over the chamber to hold the Shotshell in place for firing.</p> <p>c. Trigger — when squeezed, activates the firing mechanism to fire the rifle.</p> <p>d. Trigger guard — designed to protect the trigger in order to reduce the possibility of an unintentional firing.</p> <p>e. Magazine — holds cartridges ready for feeding into the chamber.</p> <p>f. Safety — a mechanical device designed to reduce the chance of an unintentional discharge. Since a safety is a mechanical device that can <u>fail</u>, it must be used as a supplement to safe gun handling practices, <u>never</u> as a substitute.</p>	<p><b>Review</b> the parts of the <u>barrel</u>. <b>Point</b> to each part, <b>have participants name</b> each one, and have <b>participants describe</b> briefly the function of each part.</p> <p>3. <b>Review</b> with participants the definition of the <u>action</u> by asking them to define it.</p> <p><b>Name</b> the shotgun parts listed at left, <b>point out</b> their location on the <u>action</u> of the shotgun you are using, and <b>describe</b> briefly the function of each part.</p>	
--	--	--

<p>g. Action release (if applicable) — allows a closed action to be opened</p> <p><b>G. Shotgun Parts: Review</b></p> <p><b>H. Shotgun Operation</b></p> <p>1. Loading</p> <p>2. Unloading</p>	<p><b>Review</b> the parts of the <u>action</u>. <b>Point</b> to each part, <b>have participants name</b> each one, and <b>have participants describe</b> briefly the function of each part</p> <p style="text-align: center;"><b>Skip G with Scouts</b></p> <p><b>G. Review</b> <u>all</u> the parts of the <u>stock</u>, <u>barrel</u>, and <u>action</u> listed above. <b>Point</b> to each part, <b>have participants name</b> each one, and <b>have participants describe</b> briefly the function of each part.</p> <p style="text-align: center;"><b>Lesson Time: 5 min. max</b></p> <p><b>H. Explain</b> that, in addition to firing (which will be discussed in Lesson II), there are two basic operations of most rifles: <u>loading</u> and <u>unloading</u>.</p> <p>You will be <u>explaining</u>, <u>demonstrating</u>, and <u>reviewing</u> the operations indicated. <b>Refer</b> to the general operational guidelines in the NRA Guide: <i>Basics of Shotgun Shooting</i> handbook for the type of shotgun you are using in this orientation. These guidelines discuss the indicated procedures in a clear, simple, step-by-step manner.</p> <p><b>Consult</b> the owner’s manual of your participant’s shotgun to see whether the manufacturer has any particular guidelines for its operation.</p> <p><b>Do not conduct</b> the orientation unless you are thoroughly familiar with the correct operation of the participant’s shotgun as recommended by the manufacturer.</p> <p><u>Use only dummy ammunition during this practical exercise. Dummy ammunition must be visually distinguishable from live ammunition.</u></p> <p><b>Be sure to observe, cite, and reinforce</b> the applicable NRA rules of safe gun handling throughout the exercise. <b>Note</b> that ammunition that falls to the ground must remain on the ground until it may be safely retrieved by someone who is not handling a firearm (the instructor or another participant under the instructor’s direction).</p> <p>1. <b>Explain, demonstrate, and discuss</b> the loading procedure of your participant’s shotgun in a clear, simple, step-by-step manner. Then <b>have participants repeat</b> the steps back to you as you repeat the demonstration.</p> <p>2. <b>Explain, demonstrate, and discuss</b> the unloading procedure for your participant’s shotgun in a clear, simple step-by-step manner. Then <b>have participants repeat</b> the steps back to you as you repeat the demonstration.</p>	
--	---	--

<p><b>I. Shotgun Operation Practical Exercise</b></p> <p><b>J. Conclude Lesson</b></p> <ol style="list-style-type: none"> <li>1. Summary</li> <li>2. Questions</li> <li>3. Preview</li> </ol>	<p style="text-align: center;"><b>Lesson Time: 15 min. max</b></p> <p><b>I. Review</b> with participants the three fundamental NRA rules for safe gun handling. Then <b>have participants explain and demonstrate</b> the correct loading and unloading procedures for the specific shotgun model used in this orientation.</p> <p>It is important that participants explain what they are doing during the demonstration. This will indicate to you whether or not they have learned the steps correctly, and help to reinforce the skills they are performing.</p> <p><b>Observe</b> participants closely. <b>Be sure</b> all applicable safety rules are followed. <b>Offer</b> guidance, direction, encouragement, and positive feedback as appropriate.</p> <p style="text-align: center;"><b>Lesson Time: 5 min. max</b></p> <ol style="list-style-type: none"> <li>1. <b>Ask</b> participants to:             <ol style="list-style-type: none"> <li>a. State the goal of the orientation</li> <li>b. Name the three NRA fundamental rules of safe gun handling.</li> <li>c. Name the three major components of a shotgun and describe their function.</li> <li>d. Describe the loading and unloading procedures for the specific shotgun model used in this orientation.</li> </ol> </li> <li>2. <b>Ask</b> participants what questions they have about this lesson. <b>Answer</b> questions.</li> <li>3. <b>Preview</b> next lesson briefly.</li> </ol>	
---	--	--

## Lesson II. Introduction to Ammunition and the Fundamentals of Shotgun Shooting

**Note:** Lesson II is taught on Day 2 each week of camp

**LEARNING OBJECTIVES:** As a result of their participation in this training session, participants will be able to:

1. Identify the three items they need to check to determine the proper ammunition for their shotgun.
2. Identify and define the three major types of ammunition malfunctions and explain how to respond safely when they occur.
3. Determine their dominant eye.
4. Explain and demonstrate the seven fundamentals of shotgun shooting

**LENGTH:** 45 minutes

**FACILITY:** Classroom or Range

**TRAINING AIDS:** Shotgun, shotgun owner's manual, Quality dummy ammunition, empty cartridge box for the shotgun being used, fired Shotgun case for the shotgun being used, flashlight, NRA Guide: *Basics of Shotgun Shooting* handbook, *NRA Gun Safety Rules card*





<p>a. Misfire</p> <p>b. Hangfire</p> <p>c. Squib load</p>	<p>a. A <u>misfire</u> is a failure of the shotshell to fire.</p> <p>b. A <u>hangfire</u> is a perceptible delay in the ignition of a shotshell.</p> <p>c. A <u>squib load</u> is the development of less than normal pressure or velocity after ignition of the shotshell.</p> <p><b>Explain</b> that, if a shotshell fails to fire immediately, it will not be known at first whether the problem is a <u>misfire</u> or a <u>hangfire</u>. Since the problem may be a hangfire, you should wait at least 30 seconds while keeping the gun pointed in a safe direction. After that time, the shotgun may be unloaded carefully.</p> <p><b>Explain</b> that, if anything unusual is noticed when a shot is fired, such as a difference in recoil or noise, a squib load may have been fired, and you should <u>stop firing immediately</u>. Squib loads can result in the wad (the component of the shotshell that holds the shot pellets) failing to exit the barrel. The firing of another shot could cause serious injury or damage.</p> <p><b>Explain</b> that, if a squib load is suspected, you must point the gun in a safe direction, unload it, and check the chamber to be sure that it is empty. Then, with the gun pointed in a safe direction and the action open, you must carefully run a cleaning rod through the barrel to be sure a wad is not stuck in the barrel. If the barrel is obstructed, <u>the gun must not be fired</u> until the barrel has been cleared.</p> <p><b>Review</b> the definitions of misfire, hangfire, and squib load with participants. <b>Have them explain</b> the correct actions to take if these malfunctions occur.</p> <p style="text-align: center;"><b>Lesson Time: 10 min. max</b></p>	<p>Refer Scouts to pg. 21 in MB Book</p> <p>Step B2 qualifies for teaching req. 2e</p>
<p><b>C. Determining the Dominant Eye</b></p>	<p><b>C. Explain</b> to participants that each individual has a <u>dominant eye</u>: the eye that determines the direction of vision. <b>Note</b> that the dominant eye is used to point the shotgun, so each participant must determine his or her dominant eye before learning the fundamentals of shotgun shooting.</p> <p><b>Have participants perform</b> the dominant eye exercise as described in the NRA Guide: <i>Basics of Shotgun Shooting</i> handbook. <b>Have participants note</b> which of their eyes is dominant.</p> <p><b>Note</b> that right-handed participants with a right dominant eye should shoulder the shotgun on the right side. Left-handed participants with a left dominant eye should shoulder the shotgun on the left.</p>	<p>Refer Scouts to pg. 34-35 in MB Book</p>

<p><b>D. The Fundamentals of Shotgun Shooting</b></p>	<p>If a participant is <u>cross-dominant</u> (i.e., is right-handed with a left dominant eye, or vice versa) <b>have the participant try</b> shouldering the shotgun on the same side as the dominant eye during the mounting exercise below. If the participant feels more comfortable using the shoulder opposite the dominant eye, he or she may do so. In this case, you may need to block the dominant eye with a piece of translucent tape on the inside of the non-shooting lens of the shooting glasses.</p> <p><b>Note:</b> The NRA FIRST Steps program does not have participants shooting until lesson three. The goal of the merit badge program is to have Scouts shoot on the second day of the merit badge. Therefore, this syllabus has Scouts shooting on the second day prior to lesson three. If you are doing the merit badge as part of the year-round program you should stick to the NRA lesson plan and have Scouts shoot as part of lesson three.</p> <p><b>Note:</b> Steps D1-D5 should take 8 scouts about 15 minutes. The remaining time should be used for live fire for Scouts to experience their first shot. No scoring just pull the trigger and get the first experience.</p> <p style="text-align: center;"><b>Lesson Time: 55 min. max</b></p> <p><b>D. Ask</b> participants: What does the word “fundamental” mean? What does it mean in the context of learning a skill? <b>Discuss</b> responses briefly. <b>Explain</b> that “fundamental” means “basic” or “essential.” “Fundamentals” are the essential elements of performing a skill — in the case of shooting, of firing a shot. They are important for beginners and experienced shooters alike because they must be performed each time a shot is fired.</p>	<p>Refer Scouts to pg. 36-40 in MB Book</p>
<p><b>Note:</b> Use the five step method for beginning shooters in the Merit Badge book rather than the seven step method listed here in Section D.</p>	<p><b>Name</b> the seven fundamentals of shotgun shooting. <b>Explain, demonstrate, and discuss</b> each of them as follows.</p>	<p>Step D qualifies for teaching req. 2e</p>
<p>1. Stance</p> <p>a) Stance aligned with target breaking area:</p> <p>b) Feet about shoulder width apart, with toes of lead foot turned slightly outward.</p>	<p>1. <b>Ask</b> participant(s): What do we mean by “stance”? <b>Discuss</b> responses briefly. <b>Explain</b> that <u>stance</u> refers to the position of the body while shooting, and its relationship to the target breaking area.</p> <p><b>Explain and demonstrate</b> the elements of a proper stance as described at left, and in the NRA Guide: <i>Basics of Shotgun Shooting</i> handbook.</p> <p><b>Have participant(s) practice</b> a proper stance without a shotgun. <b>Have participants describe</b> what they are doing as they assume the stance.</p>	<p>Follow steps a and b</p>

<p>c) Knee of the lead leg bent slightly; back leg straight.</p> <p>d) Approximately 60 percent of body weight on lead leg and 40 percent on back leg.</p> <p>e) Stance comfortable and balanced so that it may be maintained before, during, and after the shot.</p> <p>2. Hold point</p> <p>a) Since each shooting situation is different, each will have a different hold point.</p> <p>b) If we know where a target will first appear and in what direction it will be traveling, we can determine a good hold point for that target.</p> <p>c) The shotgun is pointed at the hold point, but the eyes are focused on the area where the target will first appear.</p> <p>3. Mount</p> <p>a) The butt of the shotgun is in the pocket of the shoulder.</p>	<p><b>Observe</b> participants closely. <b>Offer</b> guidance, direction, encouragement, and positive feedback as appropriate.</p> <p>2. <b>Ask</b> participant(s): When shooting a moving target, where should the gun be pointed <u>before</u> the target appears? <b>Discuss</b> responses briefly. <b>Explain</b> that “hold point” refers to a particular spot in the field of fire that allows for the least amount of correction when shooting a moving target.</p> <p>Discuss the elements of hold point as described at left, and in the NRA Guide: <i>Basics of Shotgun Shooting</i> handbook.</p> <p><b>Simulate</b> a straightway moving target using a flashlight beam on a wall. <b>Indicate</b> a good hold point for the target’s flight path: slightly ahead of the spot where the target will first appear. <b>Point</b> the index finger of your non-shooting hand at the hold point and <b>operate</b> the flashlight with your shooting hand. <b>Demonstrate</b> that having the gun pointed at that spot before the target appears permits the shooter to acquire the target with the least amount of correction.</p> <p><b>Have participant(s) practice</b> pointing at the hold point with their non-shooting hands and moving from the hold point to the moving flashlight beam.</p> <p><b>Observe</b> participant(s) closely. <b>Offer</b> guidance, direction, encouragement, and positive feedback as appropriate.</p> <p>3. <b>Ask</b> participant(s): What do we mean by “mount”? <b>Discuss</b> responses briefly. <b>Explain</b> that the mount is the act of bringing the shotgun into the proper position in preparation for firing the shot.</p> <p><b>Explain and demonstrate</b> the elements of proper shotgun position as described at left, and in the Shotgun Shooting handbook.</p>	
--	---	--

<p>b) The head is as far forward on the comb as possible without straining the neck.</p> <p>c) The cheek is pressed firmly against the stock.</p> <p>d) The head is erect and level.</p> <p>4. See the target</p> <p>a) Vision along the sighting plane (barrel, rib, and beads) must be directed forward so that the field of fire in which the target will appear is in focus.</p> <p>b) The target must be seen clearly at the earliest point possible so its direction of flight can be identified.</p>	<p><b>Have participant(s) practice</b> mounting an empty shotgun. <b>Have participant(s) describe</b> what they are doing as they mount the shotgun. Block the dominant eye if a cross-dominant participant feels more comfortable using the opposite shoulder.</p> <p><b>Observe</b> participant(s) closely. <b>Be sure</b> all applicable safety rules are followed.</p> <p><b>Offer</b> guidance, direction, encouragement, and positive feedback as appropriate.</p> <p>4. <b>Ask</b> participant(s): Where should the visual focus be when shooting a moving target? <b>Discuss</b> responses briefly.</p> <p><b>Explain</b> that it is vitally important that the target be in clear, sharp focus when shooting it. Note that the shooter’s entire concentration must be <u>on the target</u>.</p> <p><b>Discuss</b> the elements of seeing the target as described at left, and in the NRA Guide: <i>Basics of Shotgun Shooting</i> handbook.</p> <p><b>Have participant(s) practice</b> focusing on the flashlight beam as they track it with an empty shotgun. <b>Have participant(s) describe</b> where their focus is.</p> <p><b>Observe</b> participant(s) closely. <b>Be sure</b> all applicable safety rules are followed. <b>Offer</b> guidance, direction, encouragement, and positive feedback as appropriate.</p>	
<p>5. Swing</p> <p>a) The swing begins with the shotgun already mounted on the shoulder.</p> <p>b) The swing starts out with the muzzle of the shotgun brought from behind the target and accelerated to the target as the shot is delivered.</p>	<p>5. <b>Ask</b> participant(s): What do we mean by “swing”? <b>Discuss</b> responses briefly. <b>Explain</b> that swing refers to the manner in which the shotgun is moved relative to the target before, during, and after the shot.</p> <p><b>Note</b> that in this orientation, only a variation of the <u>pass through</u> swing with the shotgun already mounted will be taught. <b>Refer</b> participant(s) to the NRA Guide: <i>Basics of Shotgun Shooting</i> handbook for illustrations.</p> <p><b>Explain and demonstrate</b> this swing as described at left, and in the shotgun handbook.</p> <p><b>Have participant(s) practice</b> this swing using an empty gun while you simulate a straightaway target with a flashlight beam. <b>Have participant(s) describe</b> what they are doing as they swing the shotgun.</p>	

<p>6. Pull the trigger</p> <p>a) The trigger must be pulled the instant the sight picture is correct.</p> <p>b) The sight picture is the visual relationship of the shotgun muzzle to the target.</p> <p>c) When using the pass through swing, the sight picture is correct when the target appears directly above the muzzle of the shotgun.</p> <p>d) When acquiring the sight picture, the focus must be on the target.</p> <p>7. Follow-Through</p> <p>a) Follow-through means continuing to do everything that was being done at the time the shot was fired.</p>	<p><b>Observe</b> participant(s) closely. <b>Be sure</b> all applicable safety rules are followed. <b>Offer</b> guidance, direction, encouragement, and positive feedback as appropriate.</p> <p>6. <b>Ask</b> participant(s): At what point during the swing should the trigger be pulled? <b>Discuss</b> responses briefly. <b>Explain</b> that the trigger must be pulled at the instant the “sight picture” (the relationship of the muzzle to the target) is correct.</p> <p><b>Explain</b> the elements of pulling the trigger and acquiring proper sight picture as described at left, and in the NRA Guide: <i>Basics of Shotgun Shooting</i> handbook. <b>Note</b> that, when using the pass through swing, the sight picture is correct when the target appears directly above the muzzle of the shotgun.</p> <p><b>Have participant(s) repeat</b> the previous exercise and <b>have them practice</b> pulling the trigger the instant the sight picture is correct. <b>Have participant(s) describe</b> what they see when they pull the trigger.</p> <p><b>Observe</b> participant(s) closely. <b>Be sure</b> all applicable safety rules are followed. <b>Offer</b> guidance, direction, encouragement, and positive feedback as appropriate.</p> <p>7. <b>Ask</b> participant(s): How is <u>follow-through</u> used in sports such as tennis or golf? <b>Discuss</b> responses briefly. <b>Explain</b> that, in golf and tennis, it is the continuation of a motion after the golf club or tennis racket hits the ball. The same principle applies in shotgun shooting.</p> <p><b>Explain and demonstrate</b> the elements of follow-through as described at left, and in the NRA Guide: <i>Basics of Shotgun Shooting</i> handbook.</p>	
---	--	--

<p>b) The swing must continue if the shot pellets are to hit the target. The trigger is pulled while the shotgun is moving, and the gun must continue to move after the shot is fired.</p> <p><b>E. Conclude Lesson</b></p> <p>1. Summary</p> <p>2. Questions</p> <p>3. Preview</p>	<p><b>Have participant(s) repeat</b> the previous exercise and <b>have them practice</b> proper follow-through by continuing to track the flashlight beam after pulling the trigger. <b>Have participants describe</b> what they are doing after the trigger is pulled and why.</p> <p><b>Observe</b> participant(s) closely. <b>Be sure</b> all applicable safety rules are followed.</p> <p><b>Offer</b> guidance, direction, encouragement, and positive feedback as appropriate.</p> <p style="text-align: center;"><b>Lesson Time: 5 min. max</b></p> <p>1. Ask participants:</p> <ol style="list-style-type: none"> <li>a. What three items need to be checked to make sure you are using the correct ammunition for your gun? What two ammunition designations need to be checked?</li> <li>b. What are the three major types of cartridge malfunctions? What should you do if they occur?</li> <li>c. Which of your eyes is dominant? What is the dominant eye used for in shooting?</li> <li>d. What are the seven fundamentals of shotgun shooting? Where must the visual focus be at all times when shooting a moving target?</li> </ol> <p>2. Ask participants what questions they have about this lesson. Answer questions.</p> <p>3. Preview next lesson briefly.</p>	
---	---	--

### Lesson III. Introduction to Shotgun Shooting at Straightaway Targets

**Note:** Lesson III is taught on day 3 each week of camp

**LEARNING OBJECTIVES:** As a result of their participation in this training session, participants will be able to:

1. Explain the term “pull,” the loading and clearing procedures followed at a shooting station, the procedures to be followed if one has a problem with a firearm or drops ammunition, and any applicable range rules which apply to the facility being used.
2. Discuss and explain the eight NRA gun safety rules to be followed when shooting and storing a shotgun.
3. Safely shoot straightaway targets using the fundamentals of shotgun shooting.

**LENGTH:** 60 minutes

**FACILITY:** Range

**TRAINING AIDS:** Shotgun, shotgun owner’s manual, quality factory ammunition, hearing and eye protection, trap, targets, NRA Guide: *Basics of Shotgun Shooting* handbook, NRA *Gun Safety Rules* brochure.

**REFERENCES:** NRA Guide: *Basics of Shotgun Shooting* handbook.

Content	INSTRUCTIONAL NOTES	
<p><b>A. Introduce Lesson</b></p>	<p style="text-align: center;"><b>Lesson Time: 5 min. max</b></p> <p><b>A. Review</b> the previous lesson briefly. <b>State</b> learning objectives for the current lesson.</p>	
<p><b>B. Range Safety and Shooting Facility Orientation</b></p> <p>1. Range layout</p> <p>2. Range personnel</p> <p>3. Range procedures</p> <p style="padding-left: 20px;">a. “Loading and clearing”</p> <p style="padding-left: 20px;">b. “Pull”</p> <p style="padding-left: 20px;">c. “Range Commands”</p> <p style="padding-left: 20px;">d. Problem with firearm</p> <p style="padding-left: 20px;">e. Dropped ammunition</p>	<p style="text-align: center;"><b>Lesson Time: 10 min. max</b></p> <p>1. <b>Point out</b> to participants the layout of the range (e.g., shooting stations, preparation area, etc.) <b>Explain</b> the activities that are permitted in each area.</p> <p>2. <b>Introduce</b> participants to the range personnel, e.g., the chief range safety officer, other range safety officers, etc., and describe their functions.</p> <p>3. <b>Explain</b> the procedures to be used on the shotgun range:</p> <p style="padding-left: 20px;">a. <b>Explain</b> that participant(s) may load their shotguns only upon direction of the instructor. Emphasize that once the shotgun is loaded, the participant should not turn from or leave the shooting station until after the gun has been fired or unloaded, the finger removed from the trigger, and the action opened. The gun must be pointed in a safe direction at all times.</p> <p style="padding-left: 20px;">b. <b>Explain</b> the term, “Pull,” used by the shooter to call for the target.</p> <p style="padding-left: 20px;">c. <b>Explain</b> that all commands of the range officer must be followed immediately. Anyone observing an unsafe condition on the range should bring it to the immediate attention of the range officer and other shooters by calling out “cease fire.”</p> <p style="padding-left: 20px;">d. <b>Explain</b> that a shooter who has any type of problem with the shotgun must take the index finger off the trigger, keep the gun pointed in a safe direction, and raise his or her hand for assistance.</p> <p style="padding-left: 20px;">e. <b>Remind</b> participants that ammunition that falls to the ground must remain on the ground until it may be safely retrieved by someone who is not handling a firearm (the instructor or another participant under the instructor’s direction).</p>	



<p>4. Range rules</p> <p><b>C. Rules for Safe Shooting</b></p> <ol style="list-style-type: none"> <li>1. Review of the three fundamental NRA rules for safe gun handling.</li> <li>2. NRA rules for using and storing a gun. <ol style="list-style-type: none"> <li>a. Know your target and what is beyond.</li> <li>b. Know how to use the gun safely.</li> <li>c. Be sure the gun is safe to operate.</li> <li>d. Use only the correct ammunition for your gun.</li> <li>e. Wear hearing and eye protection as appropriate.</li> <li>f. Never use alcohol or drugs before or while shooting.</li> <li>g. Store guns so they are not accessible to unauthorized persons.</li> <li>h. Be aware that certain types of guns and many shooting situations require additional safety precautions.</li> </ol> </li> </ol> <p><b>D. Preparation for Shooting Exercises</b></p>	<p><b>Review</b> by asking participant(s): When does one load the shotgun? What does “Pull” mean? What should you do if you observe an unsafe situation on the range? What procedure should be followed by a shooter who is experiencing a problem with a shotgun? What should you do if you accidentally drop ammunition?</p> <p>4. Explain and discuss the range rules for the range you are using.</p> <p style="text-align: center;"><b>Lesson Time: 10 min. max</b></p> <ol style="list-style-type: none"> <li>1. Review the three fundamental NRA rules for safe gun handling by asking participants to name them.</li> <li>2. Turn with participants to the rules for using and storing guns in the NRA Gun Safety Rules card. Have participants read the first rule aloud, and then have the participants read the rest of the accompanying paragraph to themselves. Ask participants to explain the importance of the first rule. Repeat this procedure for each of the remaining rules.</li> </ol> <p style="text-align: center;"><b>Lesson Time: 10 min. max</b></p> <p><b>D.</b> Prior to the range session, <b>inspect</b> the participant’s shotgun for overall appearance, fit of parts, function, and operation. If it is a new-in-the-box shotgun, it should be cleaned before shooting. If there is any question concerning whether or not the shotgun is safe to shoot, <b>have it checked</b> by a reputable gunsmith before using it in the orientation.</p>	
--	---	--

<p><b>Note to merit badge counselor:</b></p> <p>The paragraph to the right is if you were doing a NRA First Steps class.</p> <p>When doing a Merit Badge class, please refer to the diagrams and notes that are listed under “Consideration for your Merit Badge class” on page 8 of this manual.</p> <p>For live-fire we use the Scouting America standard of one instructor to one student while loading and firing.</p> <p><b>E. Shooting Straightaway Targets</b></p> <p>1. Watch straightaway targets</p>	<p><b>Inspect</b> the ammunition to be used during the shooting exercises to be sure it is clean, free of obvious defects, and compatible with the gun. <b>Keep</b> the ammunition under your control. If there is any question concerning whether or not the ammunition is safe to use in the participant’s shotgun, <b>check</b> with a reputable gunsmith before using it in the orientation.</p> <p><b>Be sure</b> that you and all participant(s) are wearing hearing and eye protection before entering the range. <b>Prepare</b> the shooting range with the necessary equipment: a trap, targets, and the shotgun. <b>Use</b> light target loads with small shot to minimize recoil and maximize the amount of shot in the air. <b>Have</b> a copy of the NRA Guide: <i>Basics of Shotgun Shooting</i> handbook and the owner’s manual for your participant’s shotgun handy for reference.</p> <p>Set the trap to throw straightaway targets. On a trap range, have shooter stand directly behind trap house. On a skeet range, have shooter stand at station seven.</p> <p>In the case of multiple participants, there should be one NRA instructor at the shooting station, one shotgun at the shooting station, and no more than two participants at the shooting station.</p> <p><b>Be sure</b> to increase range time proportionately if you are instructing two participants</p> <p><b>Use</b> the “coach/pupil” method with multiple participants: while one participant (the “pupil”) shoots, <b>involve</b> the other participant (the “coach”) in the learning process by guiding him or her to watch the “pupil” and offer feedback under your direction.</p> <p style="text-align: center;"><b>Lesson Time: 45 min. max</b></p> <p><b>E. Instruct</b> participants using the NRA six-step method for teaching beginning shotgun shooters.</p> <p>At each step, <b>observe</b> participant closely. <b>Be sure</b> all applicable safety rules are followed. <b>Offer</b> guidance, direction, and positive feedback as appropriate.</p> <p>1. <b>Have participant(s) handle</b> a target. <b>Show</b> them how easily it breaks. <b>Have participant(s) watch</b> several targets in flight so they can get a feel for their direction and speed.</p>	<p>Refer Scouts to pg. 41-44</p> <p>Step E qualifies for teaching req. 2g</p>
--	---	---

<p>2. Point finger at target</p>	<p>2. <b>Have participant(s) assume</b> the proper stance, with the index finger of the non-shooting hand pointing to the hold point you designate. <b>Have them focus</b> their eyes on the hold point, and call, “Pull.” Upon seeing the target, participants should point at the target with the index finger and keep the finger pointed at it until it reaches the ground.</p> <p><b>Observe</b> participant(s) only. <b>Offer</b> guidance, direction, encouragement, and positive feedback as appropriate.</p>	
<p>3. Point finger and say “bang” on touching target</p>	<p>3. <b>Have participant(s) continue</b> the pointing exercise, and have them say “Bang” as soon as the sight picture is correct, to stimulate firing the shotgun. Participants should keep the finger pointed at the target until it reaches the ground as before.</p> <p><b>Observe</b> and <b>offer</b> feedback as before.</p>	
<p>4. Dry point shotgun using the fundamentals of shotgun shooting</p> <ul style="list-style-type: none"> <li>a. Stance</li> <li>b. Hold Point</li> <li>c. Mount</li> <li>d. See target</li> <li>e. Swing</li> <li>f. Pull trigger</li> <li>g. Follow thru</li> </ul>	<p>4. Direct one participant to practice the fundamentals of shotgun shooting (without pulling the trigger) on straightaway moving targets using an empty shotgun with the action open. (Hinge actions may be closed.)</p> <p><b>Review</b> the fundamentals. <b>Emphasize</b> that the entire focus should be on the target.</p> <p><b>Observe</b> participant closely. <b>Be sure</b> all applicable safety rules are followed.</p> <p><b>Offer</b> guidance, direction, encouragement, and positive feedback as appropriate.</p> <p><b>Involve</b> the other participant (the “coach”) in the learning process by guiding him or her to watch the “pupil” and offer feedback under your direction.</p>	
<p>5. Dry fire shotgun at target</p>	<p>5. <b>Have participant continue</b> the dry pointing exercise with any empty shotgun with the action closed. <b>Have participant pull</b> the trigger as soon as the sight picture is correct. <b>Have participant follow-through</b>, and <b>instruct</b> him or her to open the action after dry firing.</p> <p>(<b>Consult</b> the shotgun’s owner’s manual to see whether dry firing is approved by the manufacturer. If it is not, <b>use</b> dummy ammunition or “snap caps” to protect the shotgun from damage.)</p>	

<p>6. Shoot at target with live ammunition</p> <p><b>F. Review of Shooting Practice</b></p>	<p><b>Observe, offer</b> feedback, and <b>involve</b> the other participant as before.</p> <p>After the participant has demonstrated reasonable skill and confidence in dry firing the shotgun, move on to the next step.</p> <p>6. <b>Supply</b> participant with one round of ammunition at a time. <b>Direct</b> participant to load. When the participant is ready, <b>direct</b> him or her to call for the target and shoot. Then <b>instruct</b> participant to open the action of the shotgun. <b>Have participant fire</b> several shots.</p> <p><b>Observe</b> participant closely. <b>Watch</b> the gun, the shooter, and the result of the shot. Be sure all applicable safety rules are followed. Offer guidance, direction, and positive feedback as appropriate. Involve the other participant (the “coach”) in the learning process by guiding him or her to watch the “pupil” and offer feedback under your direction.</p> <p><b>Have participant fire</b> additional shots as time permits. <b>Use</b> the ball-and-dummy technique if necessary to help participant concentrate on technique.</p> <p><b>Have participant(s) reverse</b> roles and <b>repeat</b> the dry point, dry fire, and live fire exercises.</p> <p style="text-align: center;"><b>Lesson Time: 5 min. max</b></p> <p><b>F. Ask</b> participants what they learned from the day’s shooting practice.</p> <p><b>Discuss</b> responses briefly. <b>Supplement</b> their comments with positive feedback as appropriate.</p>	
---	---	--

**Note:** The list below uses the Shotgun Merit Badge Book page 5 to cover requirements 2k. These requirements are not found in the NRA *FIRST Steps* Lesson Plans.

**Requirement 2k.**

Shooting score required-Hit at least 12 out of 25 targets (48 percent) in two 25 target groups. The two groups need not be shot in consecutive order. **Shooters must shoot a minimum of 50 shots. This is a merit badge requirement.**

<p><b>G. Conclude Lesson</b></p> <p>1. Summary</p> <p>2. Questions</p> <p>3. Preview</p>	<p style="text-align: center;"><b>Lesson Time: 5 min. max</b></p> <p>1. Ask participants:</p> <ul style="list-style-type: none"> <li>a. What are the three basic range commands? What do they mean?</li> <li>b. What are the eight NRA safety rules for using and storing a gun?</li> <li>c. What have you learned from your practice of the fundamentals of shotgun shooting?</li> </ul> <p>2. Ask participants what questions they have about this lesson. Answer questions.</p> <p>3. Preview next lesson briefly.</p>	
--	---	--

## Lesson IV. Introduction to Shotgun Cleaning, Storage, and Training Opportunities

**Note:** Lesson IV is taught on day 4 each week of camp

**LEARNING OBJECTIVES:** As a result of their participation in this training session, participants will be able to:

1. Identify the materials needed to clean a shotgun.
2. Outline the three safety guidelines to be followed when cleaning a shotgun.
3. Explain and demonstrate how to clean a shotgun safely.
4. Name the NRA rule for safe firearm storage, and discuss options for applying this rule when storing a shotgun.
5. Discuss the three hygienic guidelines following exposure to airborne particulate lead and cleaning solvent residue.
6. Discuss the benefits of receiving additional shotgun training through the NRA Basic Firearm Training Program.

**LENGTH:** 30 minutes

**FACILITY:** Classroom or Range

**TRAINING AIDS:** Shotgun, shotgun owner’s manual, shotgun cleaning equipment, lockable shotgun case, NRA Guide: *Basics of Shotgun Shooting* handbook, *NRA Gun Safety Rules* card, one per participant of the following: *NRA Basic Firearm Training Program* brochure, and *NRA Marksmanship Qualification Program* booklet.

**REFERENCES:** NRA Guide: *Basics of Shotgun Shooting* handbook.

Content	INSTRUCTIONAL NOTES	
<p><b>A. Introduce Lesson</b></p>	<p><b>Lesson Time: 5 min. max</b></p> <p><b>A. Review</b> the previous lesson briefly. <b>State</b> learning objectives for the current lesson.</p>	
<p><b>B. Cleaning a Shotgun</b></p> <p>1. Importance of cleaning</p> <p>2. Materials</p> <p style="margin-left: 20px;">a. Cleaning rod and attachments (tips and bore brush)</p> <p style="margin-left: 20px;">b. Cloth patches</p> <p style="margin-left: 20px;">c. Bore cleaning solvent</p> <p style="margin-left: 20px;">d. Gun oil</p> <p style="margin-left: 20px;">e. Clean cloth</p> <p style="margin-left: 20px;">f. Small brush</p>	<p style="text-align: center;"><b>Lesson Time: 30 min. max</b></p> <p>1. <b>Turn</b> with participants to the NRA Gun Safety Rules card. <b>Have participants review</b> the rule, “Be sure the gun is safe to operate” and the paragraph that follows. <b>Discuss</b> the importance of regular cleaning and proper storage as part of a gun’s general upkeep as stated in the brochure. <b>Note</b> that a gun should be cleaned after every shooting session.</p> <p>2. <b>Display</b> the materials necessary to clean a shotgun. <b>Identify</b> each of the items listed at left, and <b>explain</b> their use in cleaning a shotgun.</p> <p><b>Have participants note</b> manufacturers’ guidelines for the use of gun cleaning products.</p>	<p>Refer Scouts to pg. 28-31 in MB Book</p> <p>Step B qualifies for teaching req. 2i</p>

<p>3. Safety guidelines</p> <ol style="list-style-type: none"> <li>Ammunition must not be present in the area</li> <li>The gun must be unloaded</li> <li>The action must be open</li> </ol> <p>4. Practical exercise</p> <ol style="list-style-type: none"> <li>Attach brush to cleaning rod and apply bore cleaner to brush.</li> <li>Run patch or brush through bore 8-10 times.</li> <li>Run wet patch through bore.</li> <li>Run dry patch through bore.</li> <li>If dry patch dirty, repeat first four steps until dry patch comes out clean.</li> <li>Run lightly oiled patch through bore.</li> <li>Use small brush and solvent to clean other parts of gun.</li> <li>Wipe shotgun with lightly oiled cloth.</li> </ol> <p><b>C. Hygienic guidelines following exposure to airborne particulate lead or cleaning solvent residue</b></p> <ol style="list-style-type: none"> <li>Refrain from eating, drinking, smoking, applying makeup, or otherwise placing your hands and/or fingers in proximity to your mouth or nose while on the range or while cleaning a gun.</li> </ol>	<p>3. <b>Ask</b> participants: Based on our discussions of gun safety, what are some of the safety guidelines you think should be followed when cleaning a shotgun? <b>Discuss</b> responses briefly. <b>State</b> that, when cleaning a shotgun, the guidelines listed at left <u>must</u> be followed.</p> <p>4. <b>Conduct</b> a cleaning practical exercise by having participants clean the shotgun under your direction. <b>Be sure</b> no ammunition is present in the area during the cleaning exercise.</p> <p><b>Follow</b> the cleaning guidelines outlined in the NRA Guide: <i>Basics of Shotgun Shooting</i> handbook. (The guidelines are summarized briefly at left.) <b>Note</b> that the shotgun bore should be cleaned from the breech end whenever possible.</p> <p><b>Inform</b> participants that some shotguns need to be partially disassembled prior to cleaning. <b>Have participants consult</b> the shotgun's owner's manual for disassembly/reassembly directions and for any specific recommendations the manufacturer may have regarding cleaning.</p> <p style="text-align: center;"><b>Lesson Time: 15 min. max</b></p> <p><b>Ask</b> participants: What hygienic practices should be followed during and after a shooting or gun cleaning session? <b>Discuss</b> responses briefly.</p> <p><b>Explain</b> the three hygienic guidelines at left. <b>Note</b> that they should be practiced by individuals who were present or otherwise exposed at the range even if they did not participate in the shooting session.</p>	<p>Refer Scouts to pg. 32 in MB Book</p> <p>Step 4 qualifies for teaching req. 1h</p>
--	---	---

<p>2. After leaving the range or cleaning a gun, wash your hands and face thoroughly before eating, drinking, smoking, applying makeup, or otherwise placing your hands and/or fingers in proximity to your mouth or nose.</p> <p>3. Change and wash clothing after a shooting or gun cleaning session so that exposure to airborne particulate lead or solvent residue may be further minimized.</p>		
<p><b>D. Storing a Shotgun</b></p> <p>1. NRA rule for safe firearm storage</p> <p>2. Options for safe shotgun storage</p>	<p style="text-align: center;"><b>Lesson Time: 20 min. max</b></p> <p>1. <b>Turn</b> with participants to the <i>NRA Gun Safety Rules</i> card. <b>Have participants review</b> the rule, “Store guns so they are not accessible to unauthorized persons” and the paragraph that follows. <b>Note</b> that there is not a universally applicable method for applying this rule, and that storage options must take into account each individual’s particular situation.</p> <p>2. <b>Discuss</b> some of the options available for shotgun storage, such as gun cases, cabinets, safes, etc. <b>Show</b> participants a lockable shotgun case as an example of a storage device.</p> <p><b>Note</b> that ammunition should generally be stored separately from guns, and should likewise be stored so that it is inaccessible to unauthorized persons. <b>Note</b> also that there may be state or local laws governing the storage of guns and ammunition.</p>	<p>Refer Scouts to pg. 28 and pg. 32-33 in MB Book</p> <p>Step D-1 qualifies for teaching Req. 1B</p>
<p><b>E. The “Next Step”: Additional Shotgun Shooting Activities</b></p> <p>1. The NRA Basic Firearm Training Program</p>	<p style="text-align: center;"><b>Lesson Time: 15 min. max</b></p> <p>1. <b>Discuss</b> the advantages of receiving additional shotgun training in an NRA Basic Shotgun Shooting Course. <b>Provide</b> participants with a schedule of upcoming NRA Basic Course in the area, and <b>encourage</b> them to attend.</p>	



<p>2. Additional NRA training opportunities</p> <p>3. The National Rifle Association</p> <p>4. Other shooting activities - Discuss local activities in which participants may practice and develop their shooting skills after they receive additional training. Refer participants to your NRA-affiliated shooting clubs, and local shooting ranges.</p>	<p>2. <b>Inform</b> participants that the NRA has developed additional shotgun training opportunities, including advanced marksmanship clinics for competitive shooters. <b>Note</b> that the NRA also has special programs available for young shooters, such as the NRA National Junior Rifle Camp.</p> <p>3. <b>Distribute</b> copies of NRA membership applications. <b>Discuss</b> the advantages of NRA membership and review several programs available to the shooters from the NRA, and <b>invite</b> them to join.</p> <p>4. <b>Distribute</b> <i>NRA Marksmanship Qualification Program</i> booklets. Briefly <b>describe</b> rifle programs.</p>	
---	--	--

**Note:** Instead of teaching Lesson E above, teach merit badge requirements 1d thru 1f and 1g and 1i of the Shotgun Merit Badge Book.

**Time length to teach this section is 20 minutes max.**

**Requirement 1d**

Give the main points of the laws for owning and using guns in your community and state. Consult local and state law enforcement for this information.

**Requirement 1e**

Explain how hunting is related to the wise use of renewable wildlife resources. Reference Shotgun Shooting merit badge book pages 81-82, “Conservation, Recreation, and more”.

**Requirement 1f**

Successfully complete a state hunter education course, or obtain a copy of the hunting laws for your state then do the following:

1. Explain the main points of hunting laws in your state and give any special laws on the use of guns and ammunition. Reference Shotgun Shooting Merit Badge book pages 82-83.
2. List the kinds of wildlife that can be legally hunted in your state. Refer to your state’s hunting regulations handbook.

**Note:** If a youth chooses to participate in a hunter education course, this merit badge training will take longer than the six to seven hours as stated.

**Requirement 1g**

Identify and explain three shotgun sports. Identify places in your community where you could shoot these sports and explain how you can join or be a part of shooting sports activities.

Reference Shotgun Shooting merit badge book pages 51-59, “Clay Target Sports”.

**Requirement 1i**

Give your counselor a list of sources that you could contact for information on firearms and their uses. Reference Shotgun Shooting Merit Badge book pages 94-95, “Shotgun Shooting Resources”.

After teaching the requirements above you are done with DAY 4. ...

## **DAY 5- AS TIME ALLOWS**

Continue qualification shooting as needed for the merit badge. If a Scout has met their shooting qualifications for the merit badge, have them continue shooting to qualify for the Marksmanship Qualification program awards. You can download the awards book from the internet.

<p><b>F. Conclude Lesson</b></p> <p>1. Summary</p> <p>2. Questions</p> <p><b>G. Orientation Review</b></p> <p><b>H. Orientation Certificates</b></p> <div style="border: 1px solid black; padding: 5px; width: fit-content;"><p>Since this is a merit badge class you will not have NRA certificates. Skip H and do I</p></div> <p><b>I. Thank You</b></p>	<p>1. <b>Ask</b> participant(s):</p> <ul style="list-style-type: none"><li>a. What are the materials needed to clean a shotgun?</li><li>b. What three safety guidelines must be followed when cleaning a shotgun?</li><li>c. What did you learn from the shotgun cleaning practical exercise?</li><li>d. What three hygienic guidelines should be followed after exposure to airborne particulate lead or cleaning solvent residue?</li><li>e. What is the NRA rule for safe storage of a gun?</li><li>f. What additional shotgun training opportunities are available from the National Rifle Association?</li></ul> <p>2. <b>Ask</b> participant(s) what questions they have about this lesson. <b>Answer</b> questions.</p> <p>G. <b>Ask</b> participant(s) what questions they have about anything that was covered during the orientation. <b>Answer</b> questions.</p> <p>H. <b>Distribute</b> completed NRA <i>FIRST Steps</i> Shotgun Orientation Certificates to qualified participant(s). <b>Congratulate</b> them on their accomplishments, and <b>invite</b> them to attend your next NRA Basic Shooting Course.</p> <p>I. <b>Thank</b> participant(s) for their interest in firearm education and for their participation in the training programs of the National Rifle Association.</p>	
--	--	--



## APPENDIX 2

# NRA FIRST STEPS RIFLE ORIENTATION --- INSTRUCTOR'S LESSON PLANS

# SCOUTING AMERICA RIFLE SHOOTING MERIT BADGE TEACHING GUIDE

NRA FIRST Steps Firearm Instruction, Responsibility, and Safety Training Program First Edition  
©2017 The National Rifle Association of America

All rights reserved. Printed in the United States of America This material may not be reproduced in whole or in part, by photocopying, mimeograph or by any other means without written permission. For information, write:  
Training Department, National Rifle Association, 11250 Waples Mill Road, Fairfax, VA 22030



# CONTENTS

Scouting America Introduction .....	128
How to Use This Syllabus.....	128
NRA <i>FIRST Steps</i> Introduction.....	129
Orientation Outline .....	131
Required NRA Materials.....	131
Lesson 1 Introduction to Rifle Safety, Parts, and Operation.....	132
Lesson 2 Introduction to Ammunition and the Fundamentals of Rifle Shooting .....	139
Lesson 3 Introduction to Rifle Shooting from the Benchrest Position .....	147
Lesson 4 Introduction to Rifle Cleaning, Storage, and Training Opportunities .....	152

## SCOUTING AMERICA INTRODUCTION

Welcome to the combined NRA Rifle FIRST STEPS syllabus and Merit Badge Instructor Lesson Plans for the Rifle Merit Badge. **This book is to be used by registered adult leaders who are currently certified NRA Rifle Instructors.**

The purpose of this book is to use a proven standard of instructional curriculum to teach the Rifle Merit Badge. We have combined the NRA *FIRST Steps* Rifle Syllabus with the additions from the requirements necessary to teach the Rifle Merit Badge into one document and both the Scouting America and the NRA have approved this document.

The advantage to using this document is that our youth will receive a consistently safe and proven instructional training no matter where they are trained in any council within the Scouting family.

By using this syllabus, the registered adult leader or parent who is trained as a NRA Rifle Instructor is accomplishing two important items.

First and most important, they are delivering a consistent program of responsibility and safe gun handling to our youth. Secondly, and equally important, they are using the NRA *FIRST Steps* syllabus contained in this document to satisfy the requirements of the NRA to teach a NRA *FIRST Steps* course. By using this syllabus and then registering their merit Badge course on the NRA Instructors.org portal, as an NRA *FIRST Steps* course they get credit with the NRA towards accomplishing the goal of qualifying to become a NRA Training Counselor.

The goal of both the Scouting America and the NRA is to have at least 2 NRA Training Counselors in every council in the US. By doing this we can conduct NRA instructor courses at a cost that most volunteers can afford. Thus allowing more leaders the opportunity to become NRA Rifle Instructors. These instructors will not only be able to conduct merit badge classes, but equally important, they can help provide more year-round shooting sports programs for the unit, district and council.

Thank you for all you do and we look forward to serving you in the future.

## HOW TO USE THIS SYLLABUS

This syllabus contains the NRA *FIRST Steps* program and has been modified by adding a third column to the contents outline along with some Scouting-related notes in various places within the document.

If you have never been used the NRA *FIRST Steps* syllabus, the first column tells you what you are going to do, the second column tells you how to do it or what to say and now the third column tells you what page to turn your merit badge students to and what requirements they will have completed once you do that particular assignment. When teaching the Scouts BSA Rifle Merit Badge use this syllabus as written and instead of using the NRA student rifle handbook you will use the merit badge book. Each student should have a merit badge book to follow along with the instructional component. When the syllabus says **Ask**, please ask the question, when it says **Explain**, then please explain and when it says **Demonstrate**, please demonstrate. These teaching methods have proven successful with many beginning shooters and your cooperation in following the syllabus will help you in providing a great program to our youth.

The lessons are broken up into 4 days of 1.5 hrs. minimum class time per day. This is the minimum it will take to teach this course properly. Making alterations to the class due to a 1 hr. class 4 or 5 days a week does not accomplish the goals as outlined and this book may not be used if that's the time period you have in your summer camp. Using the 1.5 to 2 hour classes usually provides students ample opportunity for them to complete their required targets during the normal merit badge sessions.

Free time in long term camp was designed for Scouts to have fun and for those not in the merit badge class to be able to still shoot at targets and give them a taste of rifle shooting so that they may wish to pursue the rifle merit badge the next time it is available.

The Rifle Merit Badge may be conducted in an off season weekend using this syllabus as you would just start at the beginning and go all the way thru the syllabus in as little as a full 6 to 8 hr. day.

For more information on how to create successful rifle shooting sports programs such as the NRA marksmanship program please contact your local council range and target activities committee.

The introduction on the next few pages gives you an idea of what the NRA *FIRST Steps* program delivers to the general public and how it should be used when teaching a Rifle Merit Badge student. The Table of Contents begins after this introduction and outlines the syllabus by camping days and lesson objectives for each day.



## NRA *FIRST Steps* INTRODUCTION

*FIRST Steps — Firearm Instruction, Responsibility, and Safety Training* — is the National Rifle Association’s response to the American public’s need for a firearm orientation program for new purchasers. New Firearm owners are encouraged to take the “first step” of obtaining training, and the NRA *FIRST Steps* Program is designed to provide a hands-on introduction to the safe handling and proper orientation of *one specific firearm model*. There are three orientations in the program: one for rifle, one for pistol, and one for shotgun.

Since *FIRST Steps* orientations are model-specific, and teach only the most basic shooting skills, they are not complete “courses” in the traditional sense of the word. They do provide a thorough introduction to firearm safety, handling, and shooting skills. These skills require regular practice. Initially, this practice should take place under the supervision of a qualified individual — like an NRA Certified Instructor or NRA Shooting Coach. For this reason, the orientation encourages participants to obtain additional training in an NRA Basic Firearm Training Course, and then to take the “next step” by participating in other local activities designed to help individuals maintain and develop their shooting skills.

### **Total Participant Involvement**

The *FIRST Steps* Orientation Program was the first NRA program designed for the new shooter that used the *Total Participant Involvement (TPI)* training methodology. Minimizing the use of lecture, TPI takes an experiential approach that stresses active training and learning by doing. Instructors guide participants to develop the specified knowledge, skills, and attitude through the use of hands-on exercises and practical applications. Keeping participants involved at every step of the training process engages their energy, holds their interest, and makes learning *fun!* At the same time, the performance-based training approach enables Instructors to evaluate the participants’ progress and provide appropriate feedback.

Like the lesson plans for NRA Basic Firearm Training Courses, the *FIRST Steps* lesson plans used a double column format of *content* and *instructional notes*: what to teach and how to teach it. The *FIRST Steps* lesson plans contain far more detail on *how to teach*, and use **bold print** to indicate directions to the Instructor. Involving participants is stressed throughout the orientation.

One example of involving participants is the NRA policy on how Instructors handle firearms. Each time they pick up a gun, they set the example by practicing the three rules of safe gun handling: making sure the gun is pointed in a safe direction, the finger is off the trigger, and the gun is unloaded. Instructors then involve the participants by having one of them verify that the gun is unloaded.

Another way to involve participants is through the use of the *coach-pupil method*, which has one Instructor, one firearm, and two participants at a shooting station on the range. While one participant (the “pupil”) shoots, the Instructor involves the other participant (the “coach”) in the learning process by guiding him or her to provide feedback under the Instructor’s direction. The Instructor then has the participants reverse roles and repeat the shooting exercise.

The *FIRST Steps* Program is designed for a low participant-to-instructor ratio. The three-hour orientation length is based on a ratio of one-to-one. The length of course lessons will need to be increased proportionately to allow multiple participants to complete all activities specified in the lesson plans. For example, in Lesson I, *each* participant must name the indicated firearm parts, describe their functions, and explain and demonstrate the loading and unloading procedures.

**A single instructor may conduct a *FIRST Steps* orientation for a maximum of four participants at a time in Lessons I, II, and IV, and two participants at a time in Lesson III.**

Instructors may combine students using different rifle models in the same *FIRST Steps* class, provided that all rifles are of the same action type (all bolt actions, all semi-automatics, etc.). Individual students in such classes are still trained on only their specific model rifle.

As in the case in NRA Basic Firearm Training Courses, Instructors should provide participants with a 10-minute break after every 50 minutes of instruction during a *FIRST Steps* orientation.

These *FIRST Steps* lesson plans should be placed in your lesson plan binder and used in conjunction with the *Basics of Rifle Shooting* handbook.

### **Policy Notes**

*FIRST Steps* orientations can be conducted by NRA Certified Instructors holding credentials in the discipline. They should follow these lesson plans as they pertain to learning objectives, training materials, equipment, orientation content, instructional methodology, and other specified details. Additional policies governing the conduct of the *FIRST Steps* Program will be periodically announced in the *NRA blog and email blasts*, sent to all NRA Instructors.

Since the *FIRST Steps* orientations are among the activities that NRA Certified Instructors are authorized to conduct, they will be entered into an instructor’s activity record. To ensure that they receive proper credit, instructors must file a completed NRA Firearm Training Course Report Form within ten days of course completion. A separate form must be submitted for each NRA *FIRST Steps* Orientation or Basic Firearm Training Course.

In conducting an NRA *FIRST Steps* orientation, instructors must provide each participant with the items in the *FIRST Steps* Rifle Participant Packet, and the other items indicated on the “Required NRA Materials” list. The number of participants on an instructor’s course report should not exceed the number of participant packets purchased by the Instructor. (Instructors are encouraged to charge a reasonable fee sufficient to recover the costs of materials and other training- related expenses.)

NRA *FIRST Steps* Orientation Completion Certificates are available only as part of the participant packet. The Instructor must indicate on the certificate the model of firearm that was used by the student in the orientation.

The owner’s manual for the participant’s rifle should be consulted prior to the orientation to see whether the manufacturer has any particular guidelines for its operation, dry firing recommendations, approved ammunition, and cleaning procedures. Instructors should not conduct the orientation unless they are thoroughly familiar with the correct operation of the participant’s rifle model as recommended by the manufacturer.

Instructors who have any questions concerning whether or not the participant’s rifle is safe to shoot should have it checked by a reputable gunsmith before using it in the orientation.

The *FIRST Steps* Program is designed to provide training with one particular firearm model — preferably the participant’s. However, individuals who do not yet own a firearm may attend a *FIRST Steps* orientation using a firearm provided by the instructor. If an instructor’s firearm is used, however, participants should be advised that the operational and handling characteristics will not be the same on a different firearm. They should be encouraged to attend a new *FIRST Steps* orientation if they later purchase a different gun.

**No live ammunition is permitted in the classroom under any circumstances, or on the range during Lessons I, II and IV if these lessons are conducted on a range. Dummy ammunition must be visually distinguishable from live ammunition to ensure that a live round is not brought to class, or to the range except during Lesson III.**

NRA Instructors may refer to guns as “firearms,” “guns,” “rifles,” etc. but not as “weapons.” “Weapon” has a negative connotation.

Establish emergency procedures to be followed in the event of an accident. All course staff must be aware of these procedures and maintain a list of emergency telephone numbers.

### **Good Luck!**

Remember, the *FIRST Steps* Program was designed with both the instructor and the participant in mind. These lesson plans will prepare you to conduct a successful orientation, and provide your participants with an exciting and informative introduction to the world of shooting.

We thank you for your commitment to firearm education and your participation in the training programs of the National Rifle Association. Your expertise and dedication will train a new generation of American shooters to exercise their firearm freedoms safely and responsibly. If you have any questions about *FIRST Steps* or the NRA Basic Firearm Training Program, please contact the NRA Training Department, 11250 Waples Mill Road, Fairfax, VA 22030, (703) 267-1500.

NRA Training Department  
Education & Training Division  
October 2006

### **Special Thanks**

This program was made possible, in part, thanks to a grant from The NRA Foundation and its generous donors.

The NRA Foundation 11250 Waples Mill Road Fairfax, VA 22030 1-800-423-6894

[www.nrafoundation.org](http://www.nrafoundation.org)  
[nraf@nrahq.org](mailto:nraf@nrahq.org)

## ORIENTATION OUTLINE

### NRA *FIRST Steps* Rifle Orientation

**Orientation Goal:** To provide beginning shooters with an introduction to the knowledge, skills, and attitude necessary to own and use a specific rifle model safely.

**Length of Orientation:** 3 hours. (All times listed are minimums.) Additional time may be needed to meet the specified learning objectives using the methodology of Total Participant Involvement.

**Note:** Use the Merit Badge Book instead of the *NRA Basics of Rifle Shooting* Handbook. Lesson times still apply.

Lesson time must be increased proportionately to allow multiple participants to complete all specified activities.)

**Participant Text:** The *NRA Basics of Rifle Shooting* handbook.

#### Orientation Lessons:

Lesson I: Introduction to Rifle Safety, Parts, and Operation (45 minutes)

Lesson II: Introduction to Ammunition and the Fundamentals of Rifle Shooting (45 minutes)

Lesson III: Introduction to Rifle Shooting from the Benchrest Position (60 minutes)

Lesson IV: Introduction to Rifle Cleaning, Storage, and Training Opportunities (30 minutes)

**SCOUTING AMERICA:** Your attached lesson plans will be taught for 1.5 hrs. each day for 4 days for a total of 6 hrs. Teaching 1 hr. classes will not fit this syllabus. Please see the time adjustments below for covering the merit badge.

#### Orientation Lessons:

Lesson I: Introduction to Rifle Safety, Parts, and Operation (45 minutes)

**Note: Teach this lesson on Day 1 for 1.5 hrs. (See syllabus)**

Lesson II: Introduction to Ammunition and the Fundamentals of Rifle Shooting (45 minutes)

**Note: Teach this lesson on Day 2 for 1.5 hrs. (See syllabus)**

Lesson III: Introduction to Rifle Shooting from the Benchrest Position (60 minutes)

**Note: Teach this lesson on Day 3 for 1.5 hrs. (See syllabus)**

Lesson IV: Introduction to Rifle Cleaning, Storage, and Training Opportunities (30 minutes)

**Note: Teach this lesson on Day 4 for 1.5 hrs. (See syllabus)**

## REQUIRED NRA MATERIALS

### NRA *FIRST STEPS* Rifle Orientation

(See current <http://materials.nrahq.org> for item numbers and prices)

**Note:** This list does not apply to merit badge classes. You only need this list if you are doing a regular NRA *FIRST Steps* class.

#### One per participant:

NRA *FIRST Steps* Rifle Participant Packet — contains the following items:

- NRA Basics of Rifle Shooting handbook
- NRA *FIRST Steps* Rifle Orientation Completion Certificate
- NRA Gun Safety Rules card
- NRA Basic Training Program brochure
- NRA Marksmanship Qualification Program booklet

**Note:** Anytime you see the *NRA Basics of Rifle Shooting* handbook as the reference use the Rifle Merit Badge Book instead

#### For reference:

*NRA Basics of Rifle Shooting* handbook

## OTHER REQUIRED EQUIPMENT

Rifle

Rifle owner's manual

Dummy ammunition (must be visually distinguishable from live ammunition)

Empty cartridge box for rifle ammunition

Fired rifle cartridge case

Paige sighting device (if available)

Quality factory ammunition (for use during live fire exercises on range only)

Hearing protection

Eye protection Targets Sandbags

Benchrests (tables) Chairs

Small screwdriver (for sight adjustment)

Rifle cleaning equipment

Lockable rifle case

## LESSON I. Introduction to Rifle Safety, Parts, and Operation

**Note:** Lesson I is taught on Day 1 each week of camp

**LEARNING OBJECTIVES:** As a result of their participation in this training session, participants will be able to:

1. State the goal of the NRA *FIRST Steps* Rifle Orientation.
2. Name the three fundamental NRA rules of safe gun handling and demonstrate them with a specific rifle model.
3. Name the three major components of a rifle and describe their functions.
4. Safely demonstrate the loading and unloading procedures for a specific rifle model with dummy ammunition.

**LENGTH:** 45 minutes

**FACILITY:** Classroom or Range

**TRAINING AIDS:** Rifle, rifle owner's manual, dummy ammunition, one per participant of the following: NRA Training Course Student Registration Card, *The Basics of Rifle Shooting* handbook, *NRA Gun Safety Rules card*

**(Note: No live ammunition is to be used during this lesson. Dummy ammunition must be visually distinguishable from live ammunition.)**

**REFERENCES:** *The Basics of Rifle Shooting* handbook.

**Note:** Anytime you see the NRA *Basics of Rifle Shooting* handbook as the reference use the Rifle Merit Badge Book instead

Content	INSTRUCTIONAL NOTES	
	<div style="background-color: #cccccc; padding: 5px; display: inline-block;"><b>Lesson Time: 10 min. max</b></div>	
<b>A. Orientation</b>		
1. Registration	1. <b>Instruct</b> participants to fill out an NRA Training Course Student Registration Card	<p><b>Note:</b> Have Scouts fill out their merit badge card</p>       <p>Items 1-10 in column 1 should only take 5 minutes to do</p>       <p>Explain the merit badge schedule for the week</p>
2. Welcome	2. <b>Introduce</b> self and welcome participants to the orientation	
3. Orientation goal	3. <b>Review</b> the orientation goal with participants: <i>To provide beginning shooters with an introduction to the knowledge, skills, and attitude necessary to own and use a <u>specific rifle model</u> safely.</i>	
4. Orientation schedule	4. <b>Review</b> the orientation content, and the times and locations of the different lessons of the orientation.	
5. Special considerations	5. <b>Review</b> any special considerations that are unique to the orientation, e.g., transportation arrangements to range facility.	
6. Facilities	6. <b>Point out</b> location of rest rooms, drinking fountain, telephone, first aid kit, fire exits, alarm, extinguishers, etc.	
7. Firearms	7. <b>Check</b> immediately any firearms to be used during the orientation to insure they are unloaded, and <b>have a participant verify</b> this.	

<p>8. No live ammunition in classroom</p> <p>9. Gun fit</p> <p>10. Basic handbooks</p>	<p>8. <b>Note</b> that no live ammunition is permitted in the classroom, and that <u>only</u> dummy ammunition will be used during the first two lessons of the orientation. <b>Check</b> with participants to be sure they have not brought any live ammunition into the classroom.</p> <p>9. <b>Check</b> the fit of the rifle to be used during this orientation relative to the size and strength of the participants. The participant should be able to hold the rifle securely and comfortably, mount it correctly, and reach and operate the appropriate parts safely and properly.</p> <p>10. <b>Distribute</b> the <i>Basics of Rifle Shooting</i> handbooks to participants. <b>Note</b> that the handbook will be used during the orientation, and may be used afterwards as a reference to review the material covered in class.</p> <p style="text-align: center;"><b>Lesson Time: 5 min. max</b></p>	<p>Distribute the merit badge books to Scouts</p>
<p><b>B. Introduce Lesson</b></p>	<p><b>State</b> learning objectives for this lesson.</p>	
<p><b>C. Rifle Safety</b></p>	<p style="text-align: center;"><b>Lesson Time: 10 min. max</b></p>	
<p>1. The importance of safety</p> <p>2. The major causes of gun accidents</p> <p>3. The fundamental NRA rules for safe gun handling</p>	<p>1. <b>Ask</b> participants: What do you think is our primary concern when handling firearms? <b>Discuss</b> responses briefly. State that <u>safety</u> is always the primary concern when handling firearms, whether the guns are located in the home, at the range or in the field.</p> <p>2. <b>Ask</b> participants: What do you think are the major causes of gun accidents? <b>Discuss</b> responses briefly. <b>State</b> that <u>ignorance</u> and <u>carelessness</u> are the primary causes: a lack of knowledge of firearm safety or operation (ignorance), or the failure to apply one’s knowledge when handling guns (carelessness).</p> <p>3. <b>Distribute</b> the <i>NRA Gun Safety Rules</i> card to participants. <b>Explain</b> that the NRA has developed three basic rules which should always be applied simultaneously when handling or using a gun.</p>	<p><b>Note:</b> Refer Scouts to pg. 18 in MB Book</p>
<p>a) <u>ALWAYS</u> keep the gun pointed in a safe direction.</p>	<p>a) <b>Turn</b> with participants to the three rules in the brochure. <b>Have participants read</b> the first rule aloud. <b>Ask:</b> What do you think is meant by a “safe direction”? <b>Discuss</b> responses briefly. <b>Explain</b> that this rule means that a gun must always be pointed so that even if it were to discharge, it would not cause injury or damage. <b>Note</b> that controlling the gun’s <u>muzzle</u> is the key, and that common sense will dictate the safest direction. <b>Indicate</b> the safe direction(s) in the facility you are using.</p> <p><b>Demonstrate</b> this rule by <b>picking up</b> a rifle, <b>identifying</b> the muzzle, and <b>noting</b> that you have it pointed in a safe direction.</p>	<p>Step 3 qualifies for teaching req. 2b</p>

<p>b) <u>ALWAYS</u> keep your finger off the trigger until ready to shoot.</p> <p>c) <u>ALWAYS</u> keep the gun unloaded until ready to use.</p>	<p>b. <b>Have participants read</b> the second rule aloud. <b>Ask:</b> If your finger is kept off the trigger, where should it be? <b>Discuss</b> responses briefly. <b>Explain</b> that the finger should rest outside the <u>trigger guard</u> or along the side of the gun.</p> <p><b>Demonstrate</b> this rule by <b>identifying</b> the trigger and trigger guard on the rifle you are holding, and <b>noting</b> that you are holding the gun with your finger off the trigger, while keeping the gun pointed in a safe direction.</p> <p>c. <b>Have participants read</b> the third rule aloud. <b>Ask:</b> How do you know whether or not a gun is unloaded? <b>Discuss</b> responses briefly. <b>Explain</b> that you check whether a gun is unloaded by removing the <u>magazine</u> (if any), opening the <u>action</u>, and visually inspecting the <u>chamber(s)</u>.</p> <p><b>Demonstrate</b> this rule by <b>identifying</b> the magazine (if any), action, and chamber(s) on the rifle you are holding, and <b>noting</b> that the magazine is out, the action open, and the chamber(s) empty. <b>Have a participant verify</b> that the gun is unloaded.</p>	
--	--	--

**Note:** The requirements listed below are not found in the *FIRST Steps Rifle Lesson Plan*. Teach these requirements prior to continuing with the *FIRST Steps Rifle Lesson Plan* to Paragraph D *Safe Rifle Handling Practical Exercise* listed below.

**Requirement 1a**

Explain why BB and pellet rifles must always be treated with the same respect as firearms. Refer Scouts to *Rifle Shooting Merit Badge Book* page 27, “Air Rifles.”

**Requirement 1b**

Describe how you would react if a friend visiting your home asked to see you or your family’s firearm(s). Refer Scouts to *Rifle Shooting Merit Badge Book* page 19, “Store guns so they are not accessible to unauthorized persons.”



<p><b>D. Safe Rifle Handling Practical Exercise</b></p>	<p style="text-align: center;"><b>Lesson Time: 15 min. max</b></p> <p><b>D. Note</b> that, when handing a firearm to another person, the three rules of gun safety must be observed simultaneously, i.e., gun pointed in a safe direction, finger off the trigger, magazine out, action open, and empty chamber(s) visible.</p> <p><b>Note</b> also that a gun should not be accepted from another person unless its magazine is out, its action open, and its empty chamber(s) visible.</p> <p><b>Hand</b> the rifle you are using in this orientation to one participant at a time.</p> <p><b>Have participants demonstrate</b> the three safety rules while handling the shotgun.</p> <p><b>Have participants describe</b> each action they perform, i.e., that they are keeping the gun pointed in a safe direction, etc. The rifle's action must remain open during this exercise, and must not be manipulated by participants at this time.</p> <p><b>Have each participant hand</b> the rifle back to you when they are done.</p> <p><b>Offer</b> guidance, direction, encouragement, and positive feedback as appropriate.</p>	<p><b>Note:</b> Refer Scouts to pg. 18 in MB Book</p> <p>Step D qualifies for teaching req. 2b</p>
<p><b>E. Rifle Parts: Major Components</b></p> <p>1. Stock</p> <p>2. Barrel</p> <p>3. Action</p>	<p style="text-align: center;"><b>Lesson Time: 5 min. max</b></p> <p><b>E. Note</b> that all rifles consist of three major components: the <u>stock</u>, the <u>barrel</u>, and the <u>action</u>.</p> <p>1. <b>Turn</b> with participants to the definition of the <u>stock</u> in the <i>Basics of Rifle Shooting</i> handbook. <b>Have participants read</b> the definition aloud. <b>Point out</b> the stock on the rifle you are using.</p> <p>2. <b>Turn</b> with participants to the definition of the <u>barrel</u> in the <i>Basics of Rifle Shooting</i> handbook. <b>Have participants read</b> the definition aloud. <b>Point out</b> the barrel on the rifle you are using.</p> <p>3. <b>Turn</b> with participants to the definition of the <u>action</u> in the <i>Basics of Rifle Shooting</i> handbook. <b>Have participants read</b> the definition aloud. <b>Point out</b> the action on the rifle you are using.</p>	<p>Refer Scouts to pg. 8 in MB Book</p> <p>Step E qualifies for teaching req. 2a</p>



**F. Rifle Parts:**

1. Stock
  - a. Butt — the rear portion of the stock which is designed to fit against the shoulder.
  - b. Comb — the top portion of the stock, on which the shooter rests the cheek.
  - c. Grip — the area where the hand grasps the stock when firing the rifle
  - d. Fore-end (or forearm) — the part of the stock that extends underneath the barrel. This is where the non-shooting hand holds the rifle to support it. When separate from the rest of the stock, it is called the forearm.
2. Barrel
  - a. Bore — the inside of the barrel. The measurement of its diameter is called the caliber of the rifle.
  - b. Muzzle — the front end of the barrel where the bullet exits.
  - c. Breech — the rear of the barrel.
  - d. Chamber — the part of the barrel, located at the breech end, which holds the cartridge at the instant of firing.
  - e. Rifling — composed of spiral lands and grooves cut into the bore. The rifling makes the bullet spin to give it stability.

**F. Rifle Parts:**

1. **Review** with participants the definition of the stock by asking them to define it.

**Name** the rifle parts listed at left, **point out** their location on the stock of the rifle you are using, and **describe** briefly the function of each part.

**Review** the parts of the stock. **Point** to each part, **have participants name** each one, and **have participants describe** briefly the function of each part.

2. **Review** with participants the definition of the barrel by asking them to define it.

**Name** the rifle parts listed at left, **point out** their location on the barrel of the rifle you are using and describe briefly the function of each part.

e. **Have participants turn** to the *Basics of Rifle Shooting* handbook for an illustration of rifling.

Refer Scouts to pg. 8 in MB Book

<p>f. Sights — used to aim the rifle.</p> <p>3. Action</p> <p>a. Receiver — the backbone to which all other parts are attached.</p> <p>b. Bolt/breech block — closes over the chamber to hold the cartridge in place for firing.</p> <p>c. Trigger — when squeezed, activates the firing mechanism to fire the rifle.</p> <p>d. Trigger guard — designed to protect the trigger in order to reduce the possibility of an unintentional firing.</p> <p>e. Magazine — holds cartridges ready for feeding into the chamber.</p> <p>f. Safety — a mechanical device designed to reduce the chance of an unintentional discharge. Since a safety is a mechanical device that can <u>fail</u>, it must be used as a supplement to safe gun handling practices, <u>never</u> as a substitute.</p> <p>g. Action release (if applicable) — allows a closed action to be opened</p> <p><b>G. Rifle Parts: Review</b></p>	<p><b>Review</b> the parts of the <u>barrel</u>. <b>Point</b> to each part, <b>have participants name</b> each one, and have <b>participants describe</b> briefly the function of each part.</p> <p>3. <b>Review</b> with participants the definition of the <u>action</u> by asking them to define it.</p> <p><b>Name</b> the rifle parts listed at left, <b>point out</b> their location on the <u>action</u> of the rifle you are using, and <b>describe</b> briefly the function of each part.</p> <p><b>Review</b> the parts of the <u>action</u>. <b>Point</b> to each part, <b>have participants name</b> each one, and <b>have participants describe</b> briefly the function of each part</p> <p style="text-align: center;"><b>Skip G with Scouts</b></p> <p><b>G. Review</b> <u>all</u> the parts of the <u>stock</u>, <u>barrel</u>, and <u>action</u> listed above. <b>Point</b> to each part, <b>have participants name</b> each one, and <b>have participants describe</b> briefly the function of each part.</p>	
--	--	--

<p><b>H. Rifle Operation</b></p>	<div style="text-align: center;"><b>Lesson Time: 5 min. max</b></div> <p><b>H. Explain</b> that, in addition to firing (which will be discussed in Lesson II), there are two basic operations of most rifles: <u>loading</u> and <u>unloading</u>.</p> <p>You will be <u>explaining</u>, <u>demonstrating</u>, and <u>reviewing</u> the operations indicated. <b>Refer</b> to the general operational guidelines in the the <i>Basics of Rifle Shooting</i> handbook for the type of rifle you are using in this orientation. These guidelines discuss the indicated procedures in a clear, simple, step-by-step manner.</p> <p><b>Consult</b> the owner’s manual of your participant’s rifle to see whether the manufacturer has any particular guidelines for its operation.</p> <p><b>Do not conduct</b> the orientation unless you are thoroughly familiar with the correct operation of the participant’s rifle as recommended by the manufacturer.</p> <p><u>Use only dummy ammunition during this practical exercise. Dummy ammunition must be visually distinguishable from live ammunition.</u></p> <p><b>Be sure to observe, cite, and reinforce</b> the applicable NRA rules of safe gun handling throughout the exercise. <b>Note</b> that ammunition that falls to the ground must remain on the ground until it may be safely retrieved by someone who is not handling a firearm (the instructor or another participant under the instructor’s direction).</p> <p>1. Loading</p> <p>2. Unloading</p>	
<p><b>I. Rifle Operation Practical Exercise</b></p>	<div style="text-align: center;"><b>Lesson Time: 15 min. max</b></div> <p><b>I. Review</b> with participants the three fundamental NRA rules for safe gun handling. Then <b>have participants explain and demonstrate</b> the correct loading and unloading procedures for the specific rifle model used in this orientation.</p> <p>It is important that participants explain what they are doing during the demonstration. This will indicate to you whether or not they have learned the steps correctly, and help to reinforce the skills they are performing.</p>	

<p><b>J. Conclude Lesson</b></p> <p>1. Summary</p> <p>2. Questions</p> <p>3. Preview</p>	<p><b>Observe</b> participants closely. <b>Be sure</b> all applicable safety rules are followed. <b>Offer</b> guidance, direction, encouragement, and positive feedback as appropriate.</p> <p style="text-align: center;"><b>Lesson Time: 5 min. max</b></p> <p>1. <b>Ask</b> participants to:</p> <ol style="list-style-type: none"> <li>a. State the goal of the orientation</li> <li>b. Name the three NRA fundamental rules of safe gun handling.</li> <li>c. Name the three major components of a rifle and describe their function.</li> <li>d. Describe the loading and unloading procedures for the specific rifle model used in this orientation.</li> </ol> <p>2. <b>Ask</b> participants what questions they have about this lesson. <b>Answer</b> questions.</p> <p>3. <b>Preview</b> next lesson briefly.</p>	
--	---	--

## Lesson II. Introduction to Ammunition and the Fundamentals of Rifle Shooting

**Note:** Lesson II is taught on Day 2 each week of camp

**LEARNING OBJECTIVES:** As a result of their participation in this training session, participants will be able to:

1. Identify the three items they need to check to determine the proper ammunition for their rifle.
2. Identify and define the three major types of cartridge malfunctions and explain how to respond safely when they occur.
3. Determine their dominant eye.
4. Explain and demonstrate the fundamentals of firing the shot and demonstrate them from the benchrest position.

**LENGTH:** 45 minutes

**FACILITY:** Classroom or Range

**TRAINING AIDS:** Rifle, rifle owner’s manual, dummy ammunition, empty cartridge box for the rifle being used, fired case for the rifle being used, sighting device (if applicable), *NRA Basics of Rifle Shooting* handbook, *NRA Gun Safety Rules card*

**NOTE:** Dummy ammunition must be visually distinguishable from live ammunition.) Live Ammo is used after lesson D1-D5 when scouts do live fire shooting

**REFERENCES:** *NRA Basics of Rifle Shooting* handbook.

<p><b>A. Introduce Lesson</b></p> <p><b>B. Rifle Ammunition</b></p> <p>1. Ammunition compatibility</p>	<p style="text-align: center;"><b>Lesson Time: 5 min. max</b></p> <p><b>A. Review</b> the previous lesson briefly. <b>State</b> learning objectives for the current lesson.</p> <p style="text-align: center;"><b>Lesson Time: 10 min. max</b></p> <p>1. <b>Turn</b> with participants to the <i>NRA Gun Safety Rules card</i>. <b>Have them read</b> the paragraph discussing the rule, “Use only the correct ammunition for your gun.”</p>	<p>Refer Scouts to pg. 35-36 in MB Book</p>
--	--	---

<p>2. Cartridge malfunctions</p> <p>a. Misfire</p> <p>b. Hangfire</p> <p>c. Squib load</p>	<p><b>Ask</b> participants: How do you know what type of ammunition should be used for a particular gun? <b>Discuss</b> responses briefly. <b>Explain</b> that most firearms have the ammunition type stamped on the <u>gun</u> itself.</p> <p>Following the NRA gun safety rules, <b>show</b> participants the ammunition designation on the rifle being used for this orientation.</p> <p><b>Ask</b> participants: How do you know whether the ammunition you have is the correct type for your gun? <b>Discuss</b> responses briefly. <b>Explain</b> that the ammunition type is identified on the <u>box</u>, and sometimes on the <u>cartridge</u> as well.</p> <p><b>Show</b> participants the ammunition designation on an empty cartridge box, and on a fired case for the rifle used for this orientation.</p> <p><b>Ask</b> participants: What three items should you check to be sure that you are using the correct ammunition for your gun? <b>Review</b> that the <u>gun</u>, the ammunition <u>box</u>, and the ammunition <u>cartridge</u> should be checked to make sure the ammunition is compatible with your gun.</p> <p><b>Note</b>, if appropriate, the ammunition with a different designation may be compatible with the participant's gun. Refer to the rifle's owner's manual for specific recommendations endorsed by the manufacturer.</p> <p style="text-align: center;"><b>Lesson Time: 10 min. max</b></p> <p>2. <b>Explain</b> to participants that there are three major types of ammunition malfunctions which may occur:</p> <p>a. A <u>misfire</u> is a failure of the cartridge to fire.</p> <p>b. A <u>hangfire</u> is a perceptible delay in the ignition of a cartridge.</p> <p>c. A <u>squib load</u> is the development of less than normal pressure or velocity after ignition of the cartridge.</p> <p><b>Explain</b> that, if a cartridge fails to fire immediately, it will not be known at first whether the problem is a <u>misfire</u> or a <u>hangfire</u>. Since the problem may be a hangfire, you should wait at least 30 seconds while keeping the gun pointed in a safe direction. After that time, the rifle may be unloaded carefully.</p> <p><b>Explain</b> that, if anything unusual is noticed when a shot is fired, such as a difference in recoil or noise, a squib load may have been fired, and you should <u>stop firing immediately</u>. Squib loads can result in the bullet failing to exit the barrel. The firing of another shot could cause serious injury or damage.</p>	<p>Step B1 qualifies for teaching req. 2c</p> <p>Refer Scouts to pg. 37 in MB Book</p> <p>Step B2 qualifies for teaching req. 2d</p>
--	--	--

<p><b>C. Determining the Dominant Eye</b></p>	<p><b>Explain</b> that, if a squib load is suspected, you must point the gun in a safe direction, unload it, and check the chamber to be sure that it is empty. Then, with the gun pointed in a safe direction and the action open, you must carefully run a cleaning rod through the barrel to be sure a bullet is not stuck in the barrel. If the barrel is obstructed, <u>the gun must not be fired</u> until the barrel has been cleared.</p> <p><b>Review</b> the definitions of misfire, hangfire, and squib load with participants. <b>Have them explain</b> the correct actions to take if these malfunctions occur.</p> <p style="text-align: center;"><b>Lesson Time: 10 min. max</b></p> <p><b>C. Explain</b> to participants that each individual has a <u>dominant eye</u>: the eye that determines the direction of vision. <b>Note</b> that the dominant eye is used to aim the rifle, so each participant must determine his or her dominant eye before learning the fundamentals of rifle shooting.</p> <p><b>Have participants perform</b> the dominant eye exercise as described in the <i>Basics of Rifle Shooting</i> handbook. <b>Have participants note</b> which of their eyes is dominant.</p> <p><b>Note</b> that right-handed participants with a right dominant eye should shoulder the rifle on the right side. Left-handed participants with a left dominant eye should shoulder the rifle on the left.</p> <p>If a participant is <u>cross-dominant</u> (i.e., is right-handed with a left dominant eye, or vice versa) <b>have the participant try</b> shouldering the rifle on the same side as the dominant eye during the mounting exercise below. If the participant feels more comfortable using the shoulder opposite the dominant eye, he or she may do so. In this case, you may need to block the dominant eye with a piece of translucent tape on the inside of the non-shooting lens of the shooting glasses.</p> <p style="text-align: center;"><b>Lesson Time: 15 min. max</b></p>	<p>Refer Scouts to pg. 39-40 in MB Book</p>
<p><b>D. Shooting Position</b></p>	<p>1. <b>Ask</b> participants: What do we mean by “shooting position”? <b>Discuss</b> responses briefly. <b>Explain</b> that <u>shooting position</u> refers to the way you hold your <u>body</u> and the way you hold the <u>rifle</u> when firing the shot. The shooting position is the platform from which all the shooting fundamentals shall be executed.</p> <p><b>Note</b> that in this orientation, only the <u>benchrest</u> position will be taught, a position in which the shooter sits at a table and fires the gun with the non-shooting hand supported by sandbags.</p> <p><b>Refer</b> participants to the <i>Basics of Rifle Shooting</i> handbook for an illustration.</p>	

<p>a) The position of the <u>body</u>:</p> <ol style="list-style-type: none"> <li>(1) The position should be comfortable, balanced, relaxed, provide maximum bone support, and be properly aligned with the target.</li> <li>(2) The participant sits behind the bench or table facing the target.</li> <li>(3) Both elbows rest on the bench.</li> <li>(4) The non-shooting hand is supported by sandbags.</li> <li>(5) The shooting hand is positioned to grasp the rifle grip.</li> <li>(6) The head is erect.</li> </ol> <p>b) The position of the rifle</p> <ol style="list-style-type: none"> <li>(1) The rifle should be positioned against the shoulder so that you can look through the sights with your dominant eye comfortably and naturally. The cheek should rest firmly against the comb of the stock.</li> <li>(2) The grip of the stock should be grasped with the lower three fingers, lightly resting the thumb on the top of the stock. The hand must be positioned so that the index finger is clear of the stock and can squeeze the trigger straight to the rear. The wrist must remain straight.</li> <li>(3) The fore-end should lie across the palm of the non-shooting hand between the thumb and index finger with the other fingers relaxed. It is best not to grip or squeeze the fore-end, though this may be necessary in larger caliber rifles in order to maintain control when firing.</li> </ol>	<p>a. <b>Explain and demonstrate</b> the elements of a proper position as described at left, and in the rifle handbook.</p> <p><b>Have participants practice</b> the proper benchrest position without a rifle. <b>Have participants describe</b> the elements as they get into position. <b>Block</b> the dominant eye if a cross-dominant participant feels more comfortable using the opposite shoulder.</p> <p><b>Observe</b> participants closely. <b>Offer</b> guidance, direction, encouragement, and positive feedback as appropriate.</p> <p>b. <b>Explain and demonstrate</b> the elements of proper rifle position as described at left, and in the rifle handbook.</p> <p>With participants seated in the benchrest position, <b>have them practice</b> the position using an empty gun. <b>Have participants describe</b> what they are doing as they bring the rifle into position.</p> <p><b>Observe</b> participants closely. <b>Be sure</b> all applicable safety rules are followed.</p> <p><b>Offer</b> guidance, direction, encouragement, and positive feedback as appropriate.</p>	<p>Follow steps a and b</p>
--	--	-----------------------------



	<p><b>Note: The following lesson is actually split into two sections. The first section is to have the scout get do steps E1-E5 and that should take 8 scouts about 15 minutes.</b></p> <p><b>The remaining time should be used for live fire for scouts to experience their first shot. No scoring just pull the trigger and get the first experience.</b></p> <p><b>The NRA FIRST Steps program does not have participants shooting until lesson three. The goal of the merit badge program is to have Scouts shoot on the second day of the merit badge. Therefore, this syllabus has Scouts shooting on the second day prior to lesson three. If you are doing the merit badge as part of the year-round program you should stick to the NRA lesson plan and have Scouts shoot as part of lesson three.</b></p>	
--	---	--

<p><b>E. The Fundamentals of Firing a Shot</b></p> <p>1. Aiming</p> <p>a. For open sights with a post or bead front sight, the front sight should be centered in the rear sight notch and the top of the front sight must be even with the top of the rear sight.</p> <p>b. For aperture sights, the front sight ring (or top of the front sight post) must be centered in the rear aperture.</p> <p>c. For telescopic sights, the eye must be positioned so that you can clearly see the entire field of view when looking through the scope.</p> <p>d. As with a telescopic sight, electronic sights that generally resemble a telescopic sight externally, but use a battery illuminated dot or reticle for aiming, eliminate the need to align a rear and front sight.</p>	<p><b>Explain</b> to participants that, although broken down into individual components, the fundamentals blend together into one integrated act of firing a shot. <b>Explain</b> that “fundamental” means “basic” or “essential.”</p> <p><b>Explain</b> and <b>demonstrate</b> the following fundamentals of shooting:</p> <p>Aiming consists of two steps. The first step in aiming is to properly align the front and rear sights with the dominant eye. This process is referred to as “sight alignment.”</p> <ul style="list-style-type: none"> <li>• The relationship between the eye, the rear sight, and the front sight (or scope).</li> </ul> <p><b>Note:</b> Maintaining proper sight alignment is crucial to accurate shooting.</p> <p>The second step is “sight picture.”</p> <ul style="list-style-type: none"> <li>• The relationship between the aligned sights (or scope) and the target.</li> </ul> <p>The eye can only focus on one object at a time. It cannot keep the rear sight, the front sight, and the target in focus simultaneously. The shooter must focus, both visually and mentally, on the front sight. The front sight should appear sharp and clear, the rear sight should look less sharp, and the target should look blurred. For telescopic sights, the scope reticle is simply centered on the target (and the target is not blurred).</p> <ul style="list-style-type: none"> <li>• Ideally, it is best to keep both eyes open while aiming. An equal amount of light is available to both eyes and depth perception is better. Facial contortions and muscle tension are also eliminated.</li> <li>• There will always be some movement of the aligned sights (or scope/dot) relative to the target. The shooter should try to maintain proper sight alignment while keeping the movement of the gun to a minimum.</li> </ul>	<p>Refer Scouts to pg. 39-44 in MB Book</p> <p>Step E qualifies for teaching MB req. 2e</p>
--	---	---

<p>2. Breath Control</p>	<p>To minimize movement of the rifle, the breathing must be stopped while the shot is fired.</p> <p>Interrupting our normal breathing cycle while firing a shot is called “breath control.”</p> <ul style="list-style-type: none"> <li>• Before each shot, take a breath. When you are pointing the front sight at the target, exhale and stop breathing. Do not breathe until after the shot is fired.</li> <li>• The shot should be fired within six to eight seconds of when you have stopped breathing. If your breath is held too long, muscle tremors may start. Point the gun in a safe direction, take your finger off the trigger, put the gun down, relax, take a few breaths, and begin the cycle again.</li> </ul> <p><b>Have participants exercise</b> proper breath control from the benchrest position. <b>Have them note</b> how movement of the gun and body is reduced during the interruption of the breathing cycle.</p>	
<p>3. Hold Control</p> <p><b>Note</b> - The first step in minimizing movement is to get into a stable shooting position, which, as discussed previously, is the platform from which all the fundamentals are executed. An arc of movement will barely be noticeable in the bench rest position.</p>	<p>Hold control is the process of maintaining the correct relationship between the shooter, gun, and target.</p> <ul style="list-style-type: none"> <li>• The “hold” is the movement of your aligned sights in relation to the target that you see while aiming. The amount and speed of movement shows how well you are controlling your hold. Your task is to hold the gun as still as possible, which is best done by relaxing and letting your position do the work for you. Concentrate on holding your body and the gun as still as you can.</li> <li>• It is impossible to attain a perfect sight picture all the time. This motion of the gun/body combination as seen through the sights on the target is called the “wobble area” or “arc of movement.”</li> <li>• The shooter needs to concentrate on the sight alignment and holding as still as possible in order to exercise effective hold control.</li> </ul>	
<p>4. Trigger Control</p>	<p><b>Ask</b> participants where the trigger is <i>located</i> and what is its <i>function</i>. <b>Discuss</b> responses briefly. <b>Review</b> the location of the trigger on the gun being used in this orientation.</p> <p>Trigger control is the process of pulling or pressing the trigger smoothly and straight to the rear firing the firearm while maintaining as near perfect sight alignment as possible and an acceptable sight picture.</p>	

<p>5. Follow-through</p>	<p>The best finger placement will allow the shooter to pull the trigger straight to the rear without causing the front sight to move in the rear sight when the trigger “break” occurs.</p> <ul style="list-style-type: none"> <li>• The middle of the pad on the fingertip – the most sensitive part of the finger – is the preferred position for finger placement. But, maintaining the best possible sight alignment as the shot is fired is much more important than putting the trigger finger in a “preferred position” on the trigger.</li> <li>• Hand size and shooter finger strength may be another factor on the exact placement of the trigger finger.</li> <li>• When squeezing the trigger each shot should come as a surprise.</li> <li>• Trigger squeeze and sight alignment must be done simultaneously while keeping the movement of the gun to a minimum.</li> </ul> <p><b>Have participants practice</b> proper trigger squeeze using an empty rifle. <b>Have participants describe</b> what they are doing while they are placing their finger on the trigger and squeezing it. (<i>Consult the rifle’s owner’s manual to see whether the manufacturer approves dry firing. If not, use dummy ammunition or “snap caps” to protect the rifle from damage.</i>)</p> <p><b>Observe</b> participants closely. <b>Be sure</b> all applicable safety rules are followed. <b>Offer</b> guidance, direction, encouragement, and positive feedback as appropriate.</p> <p>Ask participants how follow through is used in sports such as tennis or golf? Discuss the response briefly.</p> <p>In golf and tennis, follow-through is the continuation of a motion after the golf club or tennis racket hits the ball. The same principle applies in shooting.</p> <ul style="list-style-type: none"> <li>• “Follow-through is simply maintaining aiming, breath control, hold control and trigger control before, during and after firing the shot</li> <li>• Follow-through is the “glue” that holds the other fundamentals together and makes firing the center shot possible</li> <li>• If the shooter focuses on the front sight and follows-through correctly, the shooter should be able to “call the shot,” i.e., indicate its location on the target before looking at the bullet hole</li> </ul> <p><b>Have participants practice</b> proper follow-through using an empty rifle. <b>Have participants describe</b> what they are doing after the trigger breaks and why.</p> <p><b>Observe</b> participants closely. <b>Be sure</b> all applicable safety rules are followed. <b>Offer</b> guidance, direction, encouragement, and positive feedback as appropriate.</p>	
--------------------------	--	--

<p><b>F. Conclude Lesson</b></p> <p>1. Summary</p> <p>2. Questions</p> <p>3. Preview</p>	<p style="text-align: center;"><b>Lesson Time: 5 min. max</b></p> <p>1. <b>Ask</b> participants:</p> <ol style="list-style-type: none"> <li>a. What three items need to be checked to make sure you are using the correct ammunition for your gun? What two ammunition designations need to be checked?</li> <li>b. What are the three major types of cartridge malfunctions? What should you do if they occur?</li> <li>c. Which of your eyes is dominant? What is the dominant eye used for in shooting?</li> <li>d. What are the five fundamentals of firing the shot? On what must you focus, visually and mentally, while firing?</li> </ol> <p>2. <b>Ask</b> participants what questions they have about this lesson. <b>Answer</b> questions.</p> <p><b>Preview</b> next lesson briefly</p>	
--	--	--

**Lesson III. Introduction to Rifle Shooting from the Benchrest Position**

**Note:** Lesson III is taught on day 3 each week of camp

**LEARNING OBJECTIVES:** As a result of their participation in this training session, participants will be able to:

1. Explain the three basic range commands, the procedures to be followed if one has a problem with a firearm or drops ammunition, and any applicable range rules which apply to the facility being used
2. Discuss and explain the eight NRA gun safety rules to be followed when shooting and storing a rifle.
3. Safely shoot a target from the benchrest position using the fundamentals of rifle shooting.

**LENGTH:** 60 minutes

**FACILITY:** Range

**TRAINING AIDS:** Rifle, rifle owner’s manual, factory ammunition, hearing and eye protection, blank targets, sandbags, benchrests, chairs, small screwdriver (for sight adjustments), *NRA Basics of Rifle Shooting* handbook, *NRA Gun Safety Rules* card.

**REFERENCES:** *NRA Basics of Rifle Shooting* handbook.

<b>Content</b>	<b>INSTRUCTIONAL NOTES</b>	
<p><b>A. Introduce Lesson</b></p>	<p style="text-align: center;"><b>Lesson Time: 5 min. max</b></p> <p><b>A. Review</b> the previous lesson briefly. <b>State</b> learning objectives for the current lesson.</p>	
<p><b>B. Range Safety and Shooting Facility Orientation</b></p>	<p style="text-align: center;"><b>Lesson Time: 10 min. max</b></p>	

<p>1. Range layout</p> <p>2. Range personnel</p> <p>3. Range commands and procedures</p> <p>    a. “Load”</p> <p>    b. “Commence firing”</p> <p>    c. “Cease firing”</p> <p>    d. Problem with firearm</p> <p>    e. Dropped ammunition</p> <p>4. Range rules</p>	<p>1. <b>Point out</b> to participants the layout of the range: the location of the firing points, firing line, ready area, etc. <b>Explain</b> the activities that are permitted in each area.</p> <p>2. <b>Introduce</b> participants to the range personnel, e.g., the chief range safety officer, other range safety officers, etc., and describe their functions.</p> <p>3. <b>Name</b> the three basic range commands and <b>explain</b> what they mean:</p> <p>    a. <b>Explain</b> that shooters may load their rifles only after this command has been given. <b>Emphasize</b> that this command authorizes shooters to load their rifles, and nothing more. Shooters must still keep their fingers off the trigger.</p> <p>    b. <b>Explain</b> that, after this command has been given, shooters may fire their rifles when they are ready. <b>Emphasize</b> that shooters are not required to begin firing immediately.</p> <p>    c. <b>Explain</b> that, when this command is given, shooters must stop shooting <u>immediately</u>, remove their fingers from the triggers, keep their guns pointed in a safe direction, and await further instructions from the range safety officer. These instructions may include such commands as, “Unload ... Magazines out ... Actions open ... Guns on the bench.”</p> <p>    <b>Emphasize</b> that the “cease firing” command may be used during normal range operation or in an emergency situation. <u>Anyone</u> observing an unsafe situation may use the “cease firing” command.</p> <p>    d. <b>Explain</b> that a shooter who has any type of problem with the rifle must take their finger off the trigger, keep the gun pointed in a safe direction, and raise his or her hand for assistance from one of the range personnel.</p> <p>    e. <b>Remind</b> participants that ammunition that falls to the ground must remain on the ground until it may be safely retrieved by someone who is not handling a firearm (the instructor or another participant under the instructor’s direction).</p> <p>    <b>Review</b> by asking participants: What is the meaning of the command, “Load”? “Commence firing”? “Cease firing”? Who may issue the “cease firing” command? What procedures should be followed by a shooter who is experiencing a problem with a rifle? What should you do if you accidentally drop ammunition?</p> <p>4. Explain and discuss the range rules for the range you are using.</p>	
--	---	--

<p><b>C. Rules for Safe Shooting</b></p> <ol style="list-style-type: none"> <li>1. Review of the three fundamental NRA rules for safe gun handling.</li> <li>2. NRA rules for using and storing a gun. <ol style="list-style-type: none"> <li>a. Know your target and what is beyond.</li> <li>b. Know how to use the gun safely.</li> <li>c. Be sure the gun is safe to operate.</li> <li>d. Use only the correct ammunition for your gun.</li> <li>e. Wear hearing and eye protection as appropriate.</li> <li>f. Never use alcohol or drugs before or while shooting.</li> <li>g. Store guns so they are not accessible to unauthorized persons.</li> <li>h. Be aware that certain types of guns and many shooting situations require additional safety precautions.</li> </ol> </li> </ol>	<p style="text-align: center;"><b>Lesson Time: 10 min. max</b></p> <ol style="list-style-type: none"> <li>1. Review the three fundamental NRA rules for safe gun handling by asking participants to name them.</li> <li>2. Turn with participants to the rules for using and storing guns in the <i>NRA Gun Safety Rules</i> card. Have participants read the first rule aloud, and then have the participants read the rest of the accompanying paragraph to themselves. Ask participants to explain the importance of the first rule. Repeat this procedure for each of the remaining rules.</li> </ol>	<p>Refer Scouts to pg. 17-19 in MB Book</p> <p>Step C qualifies for teaching req. 1c and 2f</p>
<p><b>D. Preparation for Shooting Exercises</b></p>	<p style="text-align: center;"><b>Lesson Time: 10 min. max</b></p> <p><b>D.</b> Prior to the range session, <b>inspect</b> the participant's rifle for overall appearance, fit of parts, function, and operation. If it is a new-in-the-box rifle, it should be cleaned before shooting. If there is any question concerning whether or not the rifle is safe to shoot, <b>have it checked</b> by a reputable gunsmith before using it in the orientation.</p> <p>Use quality factory ammunition. <b>Inspect</b> the ammunition to be used during the shooting exercises to be sure it is clean, free of obvious defects, and compatible with the gun. <b>Keep</b> the ammunition under your control. If there is any question concerning whether or not the ammunition is safe to use in the participant's rifle, <b>check</b> with a reputable gunsmith before using it in the orientation.</p>	



<p><b>E. Shooting from the Benchrest Position</b></p> <p>1. Study benchrest position</p> <p>2. Practice position without rifle</p> <p>3. Practice position with rifle</p> <p>4. Align position with target</p>	<p><b>Be sure</b> that you and participants are wearing hearing and eye protection before entering the range. <b>Pre-prepare</b> the firing point with the necessary equipment: a benchrest, chair, sandbags, and the rifle. <b>Have</b> a copy of the NRA <i>Basics of Rifle Shooting</i> handbook and the owner’s manual for your participant’s rifle handy for reference.</p> <p><b>Set</b> a relatively large <u>blank</u> target approximately 50 feet in front of the firing line.</p> <p>In the case of multiple participants, there should be one NRA instructor per firing point, one rifle per firing point, and no more than two participants per firing point. <b>Be sure to increase range time proportionately if there are two participants at a firing point.</b></p> <p><b>Use</b> the “coach/pupil” method with multiple participants: while one participant (the “pupil”) shoots, <b>involve</b> the other participant (the “coach”) in the learning process by guiding him or her to watch the “pupil” and offer feedback under your direction.</p> <p style="text-align: center;"><b>Lesson Time: 45 min. max</b></p> <p><b>E. Instruct</b> participants using the NRA eight-step method for teaching beginning rifle shooters.</p> <p>At each step, <b>observe</b> participant closely. <b>Be sure</b> all applicable safety rules are followed. <b>Offer</b> guidance, direction, and positive feedback as appropriate.</p> <p>1. <b>Turn</b> with participants to the rifle handbook. <b>Review</b> the details of the benchrest position and <b>demonstrate</b> the position for participants.</p> <p>2. <b>Direct</b> <u>one</u> participant to practice what he or she has just read, heard, and seen. The gun is not yet used so the participant can concentrate totally on the position of the body.</p> <p>3. <b>Add</b> the rifle once the participant has achieved the correct body position. <b>Review</b> the elements of the position of the rifle, and <b>be sure</b> the participant performs them properly. If the participant’s rifle is a semi-automatic, <b>be sure</b> that the participant keeps the fingers away from any recoiling parts.</p> <p>4. <b>Be sure</b> the participant is positioned so that the gun points naturally at the center of the target. <b>Check</b> natural point of aim by having participant lower eyes away from the sights momentarily, and then look back at the sight picture. The aligned sights should still be on target. If necessary, <b>direct</b> the participant to adjust the position.</p>	<p>Refer Scouts to pg. 39-44 and 52-55 in MB book</p> <p>Step E qualifies for teaching req. 2g</p>
--	---	--



**Requirement 21**

Adjust sights to center the group on the target and fire five groups (five shots per group). According to the target used, each shot in the group must meet the following minimum score:

- (1) A-32 targets-9; (2) A-17 or TQ-1 targets-7; (3) A-36 targets-5

<p><b>F. Review of Shooting Practice</b></p>	<p style="text-align: center;"><b>Lesson Time: 5 min. max</b></p> <p><b>F. Ask</b> participants what they learned from the day's shooting practice.</p> <p><b>Discuss</b> responses briefly. <b>Supplement</b> their comments with positive feedback as appropriate.</p>	
	<p style="text-align: center;"><b>Lesson Time: 5 min. max</b></p> <p><b>G. Conclude Lesson</b></p> <p>1. Summary</p> <p>2. Questions</p> <p>3. Preview</p>	<p>1. <b>Ask</b> participants:</p> <p>a. What are the three basic range commands? What do they mean?</p> <p>b. What are the eight NRA safety rules for using and storing a gun?</p> <p>c. What have you learned from your practice of the fundamentals of rifle shooting?</p> <p>2. Ask participants what questions they have about this lesson. Answer questions.</p> <p>3. Preview next lesson briefly.</p>

**Lesson IV. Introduction to Rifle Cleaning, Storage, and Training Opportunities**

**Note:** Lesson IV is taught on day 4 each week of camp

**LEARNING OBJECTIVES:** As a result of their participation in this training session, participants will be able to:

1. Identify the materials needed to clean a rifle.
2. Outline the three safety guidelines to be followed when cleaning a rifle.
3. Explain and demonstrate how to clean a rifle safely.
4. Name the NRA rule for safe firearm storage, and discuss options for applying this rule when storing a rifle.
5. Discuss the three hygienic guidelines following exposure to airborne particulate lead and cleaning solvent residue.
6. Discuss the benefits of receiving additional rifle training through the NRA Basic Firearm Training Program.

**LENGTH:** 30 minutes

**FACILITY:** Classroom or Range

**TRAINING AIDS:** Rifle, rifle owner's manual, rifle cleaning equipment, lockable rifle case, *NRA Basics of Rifle Shooting* handbook, one per participant of the following: *NRA Marksmanship Qualification* booklet, *NRA Gun Safety Rules* card

**REFERENCES:** NRA Guide: *Basics of Rifle Shooting* handbook.

Content	INSTRUCTIONAL NOTES	
	<b>Lesson Time: 5 min. max</b>	
<b>A. Introduce Lesson</b>	<b>A. Review</b> the previous lesson briefly. <b>State</b> learning objectives for the current lesson.	
	<b>Lesson Time: 40 min. max</b>	
<b>B. Cleaning a Rifle</b>		
1. Importance of cleaning	1. <b>Turn</b> with participants to the <i>NRA Gun Safety Rules</i> card. <b>Have participants review</b> the rule, “Be sure the gun is safe to operate” and the paragraph that follows. <b>Discuss</b> the importance of regular cleaning and proper storage as part of a gun’s general upkeep as stated in the brochure. <b>Note</b> that a gun should be cleaned after every shooting session.	Refer Scouts to pg. 30 in MB Book
2. Materials <ul style="list-style-type: none"> <li>a. Cleaning rod and attachments (tips and bore brush)</li> <li>b. Cloth patches</li> <li>c. Bore cleaning solvent</li> <li>d. Gun oil</li> <li>e. Clean cloth</li> <li>f. Small brush</li> </ul>	2. <b>Display</b> the materials necessary to clean a rifle. <b>Identify</b> each of the items listed at left, and <b>explain</b> their use in cleaning a rifle.  <b>Have participants note</b> manufacturers’ guidelines for the use of gun cleaning products.	Step B qualifies for teaching req. 2h
3. Safety guidelines <ul style="list-style-type: none"> <li>a. Ammunition must not be present in the area</li> <li>b. The gun must be unloaded</li> <li>c. The action must be open</li> </ul>	3. <b>Ask</b> participants: Based on our discussions of gun safety, what are some of the safety guidelines you think should be followed when cleaning a rifle? <b>Discuss</b> responses briefly. <b>State</b> that, when cleaning a rifle, the guidelines listed at left <u>must</u> be followed.	
4. Practical exercise	4. <b>Conduct</b> a cleaning practical exercise by having participants clean the rifle under your direction. <b>Be sure no ammunition is present in the area during the cleaning exercise.</b>	Refer Scouts to pg. 31-32 in MB Book

<p>a. Attach brush to cleaning rod and apply bore cleaner to brush.</p> <p>b. Run brush through bore 8-10 times.</p> <p>c. Run wet patch through bore.</p> <p>d. Run dry patch through bore.</p> <p>e. If dry patch dirty, repeat first four steps until dry patch comes out clean.</p> <p>f. Run lightly oiled patch through bore.</p> <p>g. Use small brush and solvent to clean other parts of gun.</p> <p>h. Wipe rifle with lightly oiled cloth.</p> <p><b>C. Hygienic guidelines following exposure to airborne particulate lead or cleaning solvent residue</b></p> <p>1. Refrain from eating, drinking, smoking, applying makeup, or otherwise placing your hands and/or fingers in proximity to your mouth or nose while on the range or while cleaning a gun.</p> <p>2. After leaving the range or cleaning a gun, wash your hands and face thoroughly before eating, drinking, smoking, applying makeup, or otherwise placing your hands and/or fingers in proximity to your mouth or nose.</p> <p>3. Change and wash clothing after a shooting or gun cleaning session so that exposure to airborne particulate lead or solvent residue may be further minimized.</p>	<p><b>Follow</b> the cleaning guidelines outlined in the NRA <i>Basics of Rifle Shooting</i> handbook. (The guidelines are summarized briefly at left.) <b>Note</b> that the rifle bore should be cleaned from the breech end whenever possible.</p> <p><b>Inform</b> participants that some rifles need to be partially disassembled prior to cleaning. <b>Have participants consult</b> the rifle's owner's manual for disassembly/reassembly directions and for any specific recommendations the manufacturer may have regarding cleaning.</p> <p style="text-align: center;"><b>Lesson Time: 5 min. max</b></p> <p><b>C. Ask</b> participants: What hygienic practices should be followed during and after a shooting or gun cleaning session? <b>Discuss</b> responses briefly.</p> <p><b>Explain</b> the three hygienic guidelines at left. <b>Note</b> that they should be practiced by individuals who were present or otherwise exposed at the range even if they did not participate in the shooting session.</p>	<p>Step 4 qualifies for teaching req. 2i</p> <p>Refer Scouts to pg. 56 in MB Book</p> <p>Step 4 qualifies for teaching req. 1h</p>
---	---	--

<p><b>D. Storing a Rifle</b></p> <ol style="list-style-type: none"> <li>1. NRA rule for safe firearm storage</li> <li>2. Options for safe rifle storage</li> </ol>	<p style="text-align: center;"><b>Lesson Time: 5 min. max</b></p> <ol style="list-style-type: none"> <li>1. <b>Turn</b> with participants to the <i>NRA Gun Safety Rules</i> card. <b>Have participants review</b> the rule, “Store guns so they are not accessible to unauthorized persons” and the paragraph that follows. <b>Note</b> that there is not a universally applicable method for applying this rule, and that storage options must take into account each individual’s particular situation.</li> <li>2. <b>Discuss</b> some of the options available for rifle storage, such as gun cases, cabinets, safes, etc. <b>Show</b> participants a lockable rifle case as an example of a storage device.</li> </ol> <p><b>Note</b> that ammunition should generally be stored separately from guns, and should likewise be stored so that it is inaccessible to unauthorized persons. <b>Note</b> also that there may be state or local laws governing the storage of guns and ammunition.</p>	<p>Refer Scouts to pg. 23-27 in MB Book</p> <p>Step D qualifies for teaching Req. 2j</p>
<p><b>E. The “Next Step”: Additional Shotgun Shooting Activities</b></p> <ol style="list-style-type: none"> <li>1. The NRA Basic Firearm Training Program</li> <li>2. Additional NRA training opportunities</li> <li>3. The National Rifle Association</li> <li>4. Other shooting activities - Discuss local activities in which participants may practice and develop their shooting skills after they receive additional training. Refer participants to your NRA-affiliated shooting clubs, and local shooting ranges.</li> </ol>	<p style="text-align: center;"><b>Lesson Time: 5 min. max</b></p> <ol style="list-style-type: none"> <li>1. <b>Discuss</b> the advantages of receiving additional rifle training in an NRA Basic Rifle Shooting Course. <b>Provide</b> participants with a schedule of upcoming NRA Basic Course in the area, and <b>encourage</b> them to attend.</li> <li>2. <b>Inform</b> participants that the NRA has developed additional rifle training opportunities, including advanced marksmanship clinics for competitive shooters. <b>Note</b> that the NRA also has special programs available for young shooters, such as the NRA National Junior Rifle Camp.</li> <li>3. <b>Distribute</b> copies of NRA membership applications. <b>Discuss</b> the advantages of NRA membership and review several programs available to the shooters from the NRA, and <b>invite</b> them to join.</li> <li>4. <b>Distribute</b> <i>NRA Marksmanship Qualification Program</i> booklets. Briefly <b>describe</b> rifle programs.</li> </ol>	

**Note:** Instead of teaching Lesson E above, teach merit badge requirements 1d thru 1f and 1g and 1i of the Rifle Merit Badge Book.

**Time length to teach this section is 20 minutes max.**

**Requirement 1d**

Give the main points of the laws for owning and using guns in your community and state. Consult local and state law enforcement for this information.

**Requirement 1e**

Explain how hunting is related to the wise use of renewable wildlife resources. Reference Rifle Shooting merit badge book pages 80-82, “Conservation, Recreation, and more”.

**Requirement 1f**

Obtain a copy of the hunting laws for your state. Explain the main points of hunting laws in your state and give any special laws on the use of guns and ammunition.  
Reference Rifle Shooting Merit Badge book pages 82-83.

**Requirement 1g**

Identify and explain how you can join or be a part of shooting sport activities.  
Reference Rifle Shooting Merit Badge Book pages 86-89, “Olympic Games and Shooting”.

**Requirement 1i**

Give your counselor a list of sources that you could contact for information on firearms and their uses. Reference Rifle Shooting Merit Badge book pages 95-96, “Rifle Shooting Resources”.

After teaching the requirements above you are done with DAY 4.

**DAY 5- AS TIME ALLOWS**

Continue qualification shooting as needed for the merit badge. If a Scout has met their shooting qualifications for the merit badge, have them continue shooting to qualify for the NRA Marksmanship Qualification program awards. You can download the awards book from the internet.

**Note:** Skip this section for merit badge classes.

<p><b>F. Orientation Review</b></p> <p><b>G. Orientation Certificates</b></p> <p><b>H. Thank You</b></p>	<p>G. <b>Ask</b> participants what questions they have about anything that was covered during the orientation. <b>Answer</b> questions.</p> <p>H. <b>Distribute</b> completed NRA <i>FIRST Steps</i> Rifle Orientation Certificates to qualified participants. <b>Congratulate</b> them on their accomplishments, and <b>invite</b> them to attend your next NRA Basic Shooting Course.</p> <p>I. A special thanks needs to go to the NRA Foundation and its generous donors for helping make this course possible.</p> <p><b>Thank</b> participants for their interest in firearm education and for their participation in the training programs of the National Rifle Association.</p>	
--	--	--



## APPENDIX 3

### SAMPLE ONLY

**This is an example of one council's standard operating procedures.**

**Your council will need to write its SOP  
to account for individual range situations unique to its camp.**

## STANDARD OPERATING PROCEDURES FOR RIFLE, SHOTGUN, AND PISTOL RANGES

## I. Authorized Use of Range Facilities

- A. The council camp shooting ranges may be in operation only when the camp ranger gives permission. For special council/district events, shooting ranges must have the permission of council camping director.
- B. Council ranges will be under the supervision of a Range Safety Officer, 21 years of age or older, holding a current NRA Range Safety Officer certification. There must also be one or more NRA instructor(s) certified for that firearm, 21 years of age or older, holding a current NRA instructor certification. The ratio of NRA firearm-specific instructors to students is specified below.
- C. All Range Safety Officers and NRA-certified firearm instructors must have a copy of their certification(s) on file with the NRA training team/shooting sports committee as well as on their person while operating the range.
- D. The Range Safety Officer is responsible for the operation of a specific range. They are to run the range, maintain safety, and ensure all rules are followed. In order to fulfill these duties, the Range Safety Officer cannot be involved in any instruction during live fire.
- E. Rifle ranges have a ratio of one instructor to a maximum of eight students. There is also one Range Safety Officer per range.
- F. Shotgun ranges have a ratio of one instructor to one student. Current facilities can service no more than two participants and one trap. There is also one Range Safety Officer per range.
- G. Pistol ranges have a ratio of one instructor to one participant. Current facilities can service no more than six participants. There is also one Range Safety Officer per range.
- H. Range operation will conform to current National Camp Accreditation Program standards and the *Guide to Safe Scouting*. You can download from [www.scouting.org](http://www.scouting.org).
- I. For every one hour that you are open exclusively for your own unit, you must be open two hours to the camp. If there are only a couple of troops, you can contact them first to see if they are interested and then set hours accordingly.
- J. Range equipment and ammunition will be checked out by the camp ranger to the Range Safety Officer and checked back in to the camp ranger.
- K. You may have only one class and caliber of firearm and ammunition on the range during live fire.
- L. The log with the standard operating procedures must be signed each time you run a range.

- M. The use of personal firearms and personal ammunition is prohibited.
- N. Verify that if a troop, crew or ship are sponsoring the activity, that at least one registered adult leader has completed the online Range SAFETY training available at [my.Scouting.org](http://my.Scouting.org).

## II. Opening Range

- A. Check that there is sufficient eye and ear protection equipment present.
- B. Check the range and equipment for safety issues prior to the start of your sessions.
- C. When ready to open, put the range flag up to show that you are ready. (Current flag locations are marked.)

## III. Range Safety Briefing

- A. While gathered at a location outside the firing line:
  1. Introduce the range staff and who will be in charge of the range.
  2. Review the three “Fundamental Rules for Safe Gun Handling” (verbatim):
    - a. **Always** keep the gun pointed in a safe direction. (Declare that on this range “safe direction” means “toward the targets.”)
    - b. **Always** keep your finger off the trigger until ready to shoot.
    - c. **Always** keep the gun unloaded until ready to use.
  3. Review general range rules:
    - Know and obey all range commands.
    - No running or horseplay.
    - Listen to and obey the Range Safety Officer and instructor(s) at all times.
    - Shoot only at authorized targets.
    - Raise your hand to ask questions or to indicate a misfire (explain misfire).
    - Point out the spectator area.
    - Point out when and where eye and ear protection is or is not required.
    - Spectators must not converse with participants while they are on the range.
    - Participants and spectators ask permission to enter or exit the range.
    - **Remember SAFETY first.**
  4. Review equipment:
    - Explain how to hold the gun.
    - Explain how to operate the gun.
    - Explain how to sight in on the target.
    - Explain sight picture.
    - Explain how to load the gun and prepare to fire.
  5. Review the targets:
    - Explain to the participants what they will be shooting at.
    - Explain to them what they are attempting to do.
    - Discuss shot groupings.

6. Eye and ear protection. Explain how to properly put them on and fit them as required.
7. Eye dominance. Eye dominance should be checked with all participants.
8. Shooting Fundamentals. Review the five shooting fundamentals:
  - Position
  - Sight picture
  - Breathing
  - Trigger control
  - Follow-through
9. To indicate an EMERGENCY OR HAZARDOUS CONDITIONS.
  - Use the command: **“CEASE FIRE!”**
  - Purpose: To stop all shooting routinely or, in the case of an emergency, immediately.
  - Action: Participants immediately stop shooting, continue to keep their muzzle pointed downrange, remove their finger from within the trigger guard, unload and clear the firearm as instructed, and wait for further instructions.
  - **A cease-fire can be called by anyone!**

#### B. Range commands and actions:

1. To prepare the range for live fire, the following commands are recommended for you to use. Please use your discretion in using them:
  - a. Command: **“Move forward/take your position on the firing line.”**
    - Purpose: To get participants into position to prepare to begin shooting.
    - Action: Participants will move from behind the ready line to their assigned position. Remind them as required: **DO NOT TOUCH YOUR RIFLE!** Let them get comfortable, and ensure they are in the correct position.
  - b. Command: **“Protective gear on.”**
    - Action: Participants should put on their eye protection first, then ear protection.
  - c. Command: **“You may pick up your rifles.”**
    - Action: Participants will pick up their rifle, sight in on the target, make any final adjustments, and prepare to load.
  - d. Command: **“Load!”**
    - Purpose: To notify the Participants that they may load their first round.
    - Action: Participants will load their first round, close the bolt, keep their finger off the trigger, and wait for the next command.
  - e. Command: **“Is the line ready?”**
    - Purpose: To determine if all participants along the line are ready.
    - Action: All participants NOT ready should indicate their status to the Rangemaster. Sufficient time will be allowed for the participant to complete their preparation.
  - f. Command: **“Ready on the right?”**
    - Purpose: To declare that the participants have indicated they are ready on the right side of the range.

- Action: Any participant not ready at this command may choose to either alert the Rangemaster that they are not ready or to complete the process of getting ready before the final command has been given.
- g. Command: **“Ready on the left?”**
    - Purpose: To declare that the participants have indicated they are ready on the left side of the range.
    - Action: Any participant not ready at this command may choose to either alert the Rangemaster that they are not ready or to complete the process of getting ready before the final command has been given.
  - h. Command: **“The firing line is ready.”**
    - Purpose: To notify all participants that the range is about to be under live fire.
    - Action: Participants simply await the next command. If anyone is not ready at that point, they should notify a Rangemaster. (Audible or raised hand)
  - i. Command: **“Commence firing!”**
    - Purpose: To declare that the range is formally open for live fire.
    - Action: The participants may commence the prescribed course of fire.
2. To stop firing and declare the range safe:
    - a. Command: **“Cease fire!”**
      - Purpose: To stop all firing.
      - Action: All participants shall open the bolt, lay the rifle down with the bolt up, and remain in position until given further instructions. **If magazines are used, range commands must include “magazines out after firing all your shots”**
    - b. Command: **“Range is clear.”**
      - Purpose: The Range Safety Officer is telling all participants that all guns are unloaded.
    - c. Command: **“Remove protective gear.”**
    - d. Command: **“Pick up your brass, place it in the bucket, and get a new target.”**
    - e. Command: **“You may go change your targets.”**
      - Actions: Participants may move through the gate to the target area.

#### C. Move to the firing line gate:

1. Review again the three Fundamental Rules for Safe Gun Handling (verbatim).
2. Point out the ready line:
  - Participants DO NOT cross the line until instructed to do so by the Range Safety Officer.
  - Participants move back and forth across the line ONLY when instructed to do so by the Range Safety Officer.
  - Participants DO NOT touch the guns until instructed to do so by the Range Safety Officer.

#### IV. Move Onto the Firing Line

- A. Stay behind the ready line.
- B. Explain the “prescribed course of fire,” e.g., how many rounds, time, targets, etc.
- C. Explain “Misfire!” and procedures:
  - A misfire occurs when you pull the trigger and the gun does not fire.
  - Continue to keep the gun pointed at the target and raise your hand, and an instructor will assist you. Also explain “hang fire” and the procedure to be followed.
- D. Review the command **“Load.”**
  - Upon this command, participants may load one round and prepare to fire, but **MUST NOT** fire until the command “Commence firing” is given.
- E. Review the command **“Cease fire”** and explain that participants may also call “Cease fire.”
- F. Begin the firing session:
  - Command: **“Move forward/take your position on the firing line.”**
  - Command: **“Protective gear on.”**
  - Command: **“You may pick up your rifles.”**
  - Command: **“Load.”**
  - Command: **“Is the line ready?”**
  - Command: **“Ready on the right?”**
  - Command: **“Ready on the left?”**
  - Command: **“Ready on the firing line?”**
  - Command: **“Commence firing.”**
  - Command: **“Cease fire.”**
  - Command: **“Range is clear.”**
  - Command: **“Remove protective gear.”**
  - Command: **“Pick up your brass, place it in the bucket, and get a new target.”**
  - Command: **“You may go change your targets.”**
- G. Repeat the commands for each firing sequence.
- H. Leave the range through the gate.

#### V. Closing Procedures

- A. Clear the range of all nonessential personnel.
- B. Put all range equipment away appropriately.
- C. Clean firearms properly.
- D. Remove flag when leaving range.
- E. Return all equipment to the ranger.
- F. Return signed SOP log book to the ranger.

#### VI. Emergency Procedures

- A. Take charge of the situation.
- B. Render aid.
- C. Call for help.
- D. Direct medical help to the location.
- E. Take notes and file an incident report. (Incident report forms can be obtained from the ranger, council staff, or council office and must be filed with the ranger and council office.)

# APPENDIX 4 - RANGE AND TARGET ACTIVITIES DECISION TREE

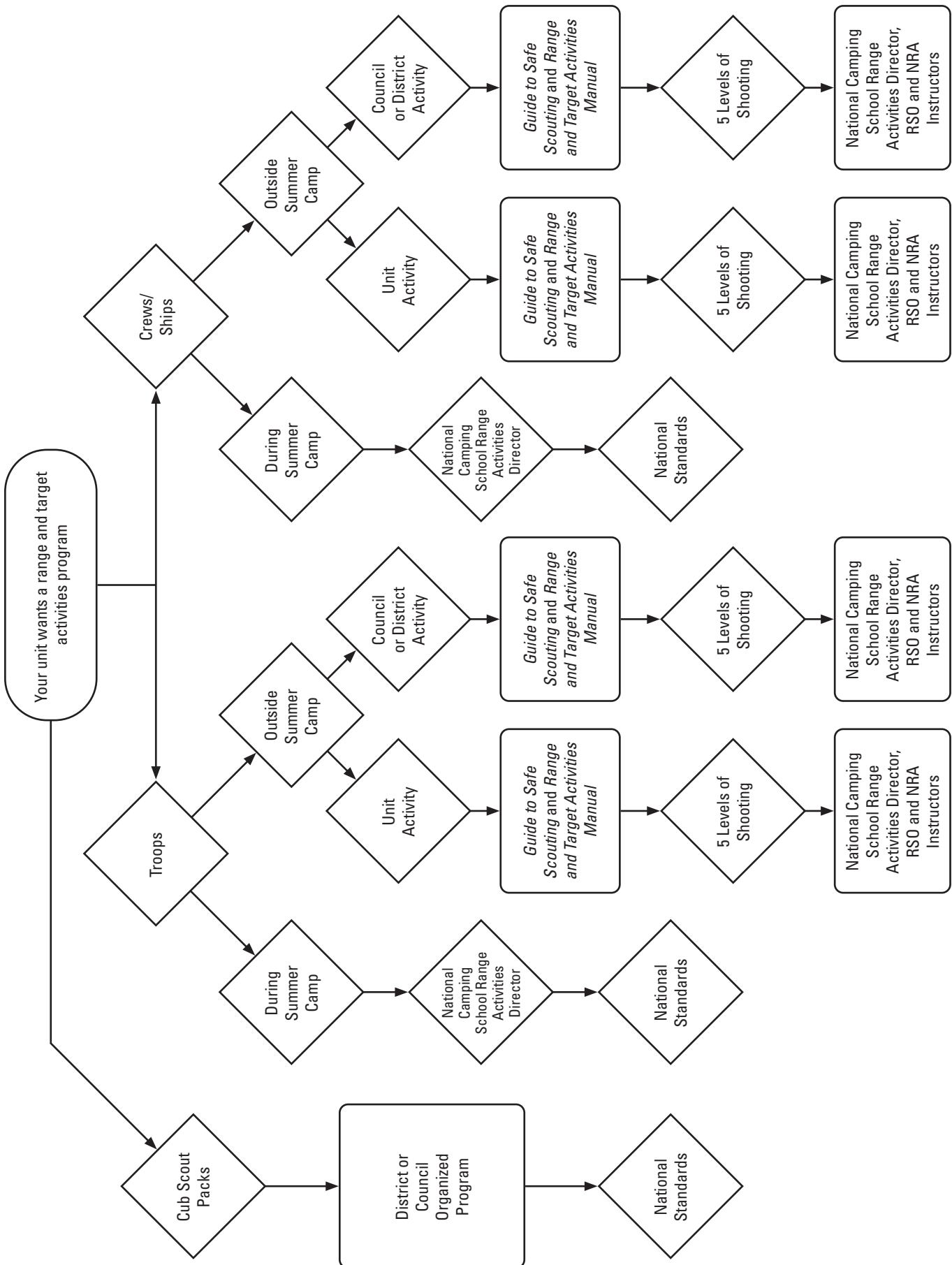



## APPENDIX 5 - CUB SCOUT BB GUN SHOOTING SPORTS

### ***BB Gun Community Event Program***

A BB gun range can be set up at a community event, county or state fair, or other similar event. A BB gun activity allows councils and districts to promote adventure as they recruit youth to Scouting America. These events must be council- or district-sponsored only, not pack, or den events.

**Youth.** Minimum age: Tigers through Arrow of Light Scouts (already registered or of joining age)

**Equipment.** A smoothbore, spring-piston, or air rifle that propels BBs. The barrel velocity must be a maximum of 350 feet per second.

**Ammunition.** BBs only

**Participant safety.** Eye protection is required for all individuals on the range.

**Participant training/facility setup.** Spend five minutes reviewing the NRA's three rules of gun safety. Guns are tethered to a table and are loaded by instructors. Youth aim at targets and fire. Bench rest position only; large bull's-eye targets with a target carrier system; resetting metallic targets, balloons, or other fun, breakable targets.

**Range supervision and ratio.** One Scouting America BB Gun Rangemaster OR one currently certified National Camping School Range Activities Director OR an NRA-certified rifle instructor for every eight participants AND one adult supervising each Cub Scout participant while shooting. These additional adults may be parents, legal guardians, or other responsible adults.

### ***BB Gun Open Shooting Program for Fun***

Councils and districts can conduct programs for fun and to introduce Cub Scout-aged youth to shooting sports programs while recruiting them into Scouting. These events must be council or district events only, not den or pack events.

**Examples.** This program could be a day-at-the-range event (fun shoot), NRA Day event (contact the National Rifle Association for information on NRA Day), Winchester/NRA Marksmanship Qualification Program,

Cuboree, or district or council camp weekend shooting event. A BB gun open shooting experience could be held at a Scouting America facility or at a facility that has been approved by the council for district- or council-level activities. These facilities may have previously held day camps or resident camps for Scouting America summer camping programs.

**Youth.** Tigers through Arrow of Light Scouts

**Equipment.** Defined as a smoothbore, spring-piston, or air rifle propelling shot known as BBs. The barrel velocity must be a maximum of 350 feet per second.

**Ammunition.** BBs only

**Range.** A Scouting America-approved range. Ranges must meet the Scouting America range design guidelines available at <https://www.scouting.org/outdoor-programs/properties/resources/design-guidelines/>.

**Training.** Scouting America BB gun briefing taught by a BB Gun Rangemaster, National Camping School Range Activities Director, or an NRA-certified rifle instructor.

The NRA's three rules for safe gun handling will be taught, and the parts of a BB gun will be reviewed. See pages 55 and 61 of this manual.

**Participant safety.** Eye protection is required for all individuals on the range.

**Range supervision.** A BB Gun Rangemaster, National Camping School Range Activities Director, or an NRA-certified rifle instructor is to directly supervise the range, and one parent or legal guardian per participant must be present.

**Ratio.** One qualified instructor for every eight shooters AND one adult for each Cub Scout while they are shooting. These additional adults can be parents or guardians.

**Course.** Bench rest, prone, or standing. Targets could be paper, resetting metallic targets, balloons, or other fun, breakable targets. You can also use the Winchester/NRA Marksmanship Qualification Program.



## ***BB Gun District- or Council-Level Competitive Range and Target Activities Program***

**Purpose.** Retention of Cub Scouts, Webelos Scouts and Arrow of Light Scouts by offering progressive, year-round range and target activities within a district and/or council. The program could begin with competition at a district level with the packs competing against each other, and the top pack in the district could advance to the finals competing against other packs at a council-wide event.

This event must be council- or district-sponsored only, not a den or pack event.

**Examples.** Ongoing programs include BB gun leagues sponsored by the district or council or a weekend BB gun event where the Cub Scouts, Webelos Scouts, and Arrow of Light Scouts are invited to participate in a shooting event; Scouts shoot for high score, best shot, or other rankings.

**Youth.** Minimum age: Tiger Cub- through Arrow of Light Scout-aged youth (already registered or of joining age)

**BB guns.** Smoothbore, spring-piston, or air rifle propelling shot known as BBs. The barrel velocity must be a maximum 350 feet per second.

**Ammunition.** BBs only.

**Range.** Ranges must meet the Scouting America range design guidelines available at <https://www.scouting.org/outdoor-programs/properties/resources/>

[design-guidelines/](#).

**Training.** Scouting America BB gun briefing taught by Rangemaster, National Camping School Range Activities Director, or an NRA-certified rifle instructor. See pages 57-58 of this manual for acceptable shooting positions.

**Safety.** Eye protection is required while using BB guns or air rifles.

**Range supervision.** A Scouting America BB Gun Rangemaster, National Camping School Range Activities Director, or an NRA-certified rifle instructor must directly supervise the range.

**Ratio.** One qualified instructor for every eight participants.

**Course.** The format can be similar to a pinewood derby competition. A set number of weeks would be established, allowing the Scouts to shoot once a week and keep score. Scouts first shoot on a district level, with Scouts from different packs competing against each other to determine the top three shooters in the district. The top scorers would then move on to a final competition at the council level, and the top three would be awarded a council trophy.

# TRAINING ARCHERY RANGEMASTERS

Use this outline to train archery Rangemasters. (*Topics noted are included in this appendix unless otherwise noted.*) **(This training may only be conducted by a National Camping School Certified Range Activities Director OR a USA Archery Level 1, 2 or 3 Instructor approved by the Council Shooting Sports Committee.)**

## Section I (75 min)

- A. How To Set Up An Outdoor Target Archery Range (*Use diagram in appendix*)
- B. A Brief History of Archery
- C. Safety
  - 1. Safety Guidelines
  - 2. Sun Safety on the Shooting Range
- D. Equipment
  - 1. Review bows, bowstrings, arrows, arm guards, finger tabs, quivers, points of aim, target butts, target faces, and backstops.
  - 2. Review how to string and unstring a bow, and have participants demonstrate this.
  - 3. Review how to maintain, store, and care for equipment.
- E. Range Layout
  - 1. This topic is to be taught on the archery range which was set up at the beginning of this section.
  - 2. Review the range layout, safety fencing, backstop, entryway, range flag, target spacing, waiting line, shooting line, and bow racks and quivers.
- F. Range Operation Rules
  - 1. Review range operation rules, including a sample Range Rules poster.

## Section II (40 min)

- A. Archery Shooting Basics
  - 1. Eye-Dominance
  - 2. Stance
  - 3. Nock and Arrow
  - 4. Establish the Bow Hold
  - 5. Draw
  - 6. Aim
  - 7. Anchor
  - 8. Release/Loose
  - 9. Follow-Through
  - 10. Retrieve Arrows
- B. Targets and Scoring
  - 1. Target Butts
  - 2. Target Faces (*cover scoring targets*)
  - 3. Backstops

- C. Know the Proper Whistle Commands
  - 1. 2 blasts – advance to the shooting line
  - 2. 1 blast – pick up bows, nock and arrow and begin shooting
  - 3. 3 blasts – retrieve arrows
  - 4. 5 or more blasts – EMERGENCY, STOP SHOOTING, BOWS DOWN
- D. Archery Practice Fun
  - 1. One candidate will act as the range officer. Remainder of the group shoot on the range. (*This can be rotated through the archers as time permits.*)

## Section III (25 min)

- A. Training Cub Scouts
  - 1. Training Cub Scouts
  - 2. Teaching Tips
  - 3. Cub Scout Archery Training – Youth (*review syllabus*)
- B. Shooting a Competitive Round
  - 1. Differentiate between an end and a round
- C. Archery Games & Activities
  - 1. Review activities listed
  - 2. Ask archers to share any other activities they can think of.
- D. Cub Scouts and Archery
  - 1. Lions and Tigers MUST shoot with an adult partner
  - 2. Instructor to participant ratio for Cub Scouts is 1 instructor to 8 participants
- E. Cub Scout Range and Target Elective Adventures. Review information available at <https://www.scouting.org/outdoor-programs/>
- F. Slingshot (*Refer to **Scouting America National Range and Target Activities Manual**, No. 430-938, **Other Shooting Activities (Slingshot)***)
  - 1. Equipment
  - 2. Targets
  - 3. Slingshot ammunition
- G. Slingshot (*Refer to **Scouting America National Range and Target Activities Manual**, No. 430-938, **Other Shooting Activities (Slingshot)***)
  - 1. Slingshot and Wrist braced Slingshot Guidelines
  - 2. Range Commands (*Refer to <https://www.scouting.org/outdoor-programs/>*)

# TRAINING BB GUN RANGEMASTERS

Use this outline to train BB gun Rangemasters. (*Topics noted are included in this appendix unless otherwise noted.*) **(This training may only be conducted by a National Camping School Certified Range Activities Director OR an NRA Rifle Instructor approved by the Council Range and Target Activities Committee.)**

## Section I (30 min)

- A. A Brief History of BB Guns
- B. Safety
  - 1. Safety Guidelines
  - 2. What Causes Gun Accidents
  - 3. Safety Reminders
  - 4. Sun Safety on the Shooting Range
- C. Equipment
  - 1. Parts of a BB Gun
    - a. Review diagram of Spring-Piston Gun (*If your camp uses a different gun, review the parts of that gun with participants.*)
    - b. Cover stock, butt, trigger, trigger guard, forearm, muzzle, front sight, barrel, rear sight, and safety.
    - c. Review how to load and unload the BB Gun
  - 2. Targets & Ammunition
    - a. Targets (Refer to <https://www.scouting.org/outdoor-programs/>)
    - b. Ammunition (bb's: .177 caliber spheres OR .177 caliber pellets)
  - 3. Equipment Maintenance & Storage
    - a. The BB Gun must be unloaded.
    - b. The safety mechanism should be engaged. (*If there is one.*)
    - c. The BB Gun should be protected from scratches and scraps from other guns.
    - d. The BB Gun should be locked or otherwise secured in a safe, dry location, separate from the ammunition.)

## Section II (35 min)

- A. Range Layout (*Use diagram in appendix.*)
  - 1. Review range layout, safety fencing, back-stop, entryway, range flag, target spacing, waiting line, and firing line.
  - 2. Set up a BB Gun range if possible. (*If not, reinforce points from diagram on actual range.*)
- B. Range Operation Rules

## Section III (50 min)

- A. Training Cub Scouts
  - 1. Training Cub Scouts
  - 2. Teaching Tips
  - 3. Review Cub Scout BB Gun Elective Adventures Lesson Plans
- B. BB Gun Shooting Basics
  - 1. Eye Dominance
  - 2. Shooting Shoulder
  - 3. Breathing
  - 4. Sight Alignment
  - 5. Trigger Squeeze
  - 6. Follow-Through
- C. Shooting Positions
  - 1. Free-Arm Standing Position
  - 2. Prone Position
  - 3. Kneeling Position
  - 4. Sitting Position
  - 5. Bench Rest Position (***Not in appendix, review if used in your camp.***)
- D. Safety Guidelines
  - 1. Review paragraph preceding basic rules.
  - 2. Review steps 1-12 with emphasis on first three: ***Always keep the gun pointed in a safe direction.***  
***Always keep your finger off the trigger until ready to shoot.***  
***Always keep the gun unloaded until ready to use.***
- E. Range Commands
- F. BB Gun Shooting Practice
  - 1. Review three rules of safe gun handling.
  - 2. Review five basics of shooting.
  - 3. Have one of the candidates run at least one string of participants through the line.

## Section IV (35 min)

- A. BB Gun Shooting Games & Activities
  - 1. Fun Target Activities
  - 2. Tic Tac Toe
  - 3. Bikathlon
- B. Age Appropriate Guidelines for BB Gun
  - 1. Lion Cub Scouts – *Not permitted*
  - 2. Tiger Cub Scouts – Only with adult partner at council/district outdoor program
  - 3. Wolf, Bear, Webelos, and Arrow of Light – Only at council/district outdoor program
- C. Range and Target Elective Adventures. Review information available at <https://www.scouting.org/outdoor-programs/>
- D. Slingshot (**Scouting America National Range and Target Activities Manual**, No. 430-938, ***Other Shooting Activities***)

## APPENDIX 6 - PROHIBITED ACTIVITIES

To review all Scouting America unauthorized activities,  
please visit <https://www.scouting.org/health-and-safety/gss/gss07/>



## APPENDIX 7 - OPEN SHOOTING ARCHERY EXPERIENCE

### For Scouts BSA, Venturers And Sea Scouts

#### INTRODUCTION

This guide is intended to provide units, districts and councils with an overview of the requirements for running the Archery program. All Scouting America Policies must be followed and instructors are required to be certified as a USA Archery Level 1 Instructor. In this appendix, you will find youth requirements and training requirements for adults who are providing archery programs.

This program offers a fun and safe introduction to Archery.

#### PROGRAM GUIDELINES

##### Youth Requirements

To participate in the archery program the following requirements must be met:

- Participants must be registered in Scouts BSA, Venturers or Sea Scouts
- Youth not registered in an official program must meet the required age guidelines to participate at a recruiting event.



#### STANDARD OPERATING PROCEDURES

The standard operating procedures (SOPs) of the range should also be reviewed by USA Archery Level 1 Instructor before delivering this program. All equipment must be approved for use by the USA Archery Level 1.

#### THE RANGE

An approved range can include:

- Scouting America Range at an NCAP accredited camp property
- Public Range
- Private Range
- Commercial range
- Private Property Range

#### ADULT SUPERVISION AND TRAINING REQUIREMENTS

1. Scouting America Youth Protection policies for two deep leadership must be maintained at all times.
2. Instructors must have current USA Archery Level 1 Instructor certification and be at least 18 years of age.



## APPLICABLE LAWS

Scouting America safety policies generally run parallel to or go beyond legal mandates. However, it is the camp or activity supervisor's responsibility to confirm and ensure compliance with all applicable federal, state, and local regulations or statutes related to youth using archery equipment.



## OPERATING PROCEDURES

The procedures outlined in the USA Archery Level 1 Instructor manual provides the guidelines for operating an indoor or outdoor archery range. All archery equipment used during the open shoot must be approved for use by the USA Archery Level 1 Instructor.

### THE RANGE

An approved range can include:

- Scouting America Range at an NCAP accredited camp property
- Public or private commercial range
- Private property or club

Ranges must be set up under leadership of the USA Archery Level 1 Instructor.

### OPEN ARCHERY SHOOTING EXPERIENCE

**Purpose:** Introduce and recruit Scouts into archery programs.

**Examples:** A day-at-the-range event (fun shoot), camporee, or Order of the Arrow event are examples. An open shooting experience could be held at an NCAP accredited camp property, public, private, commercial or club range.

**Youth:** Scouts BSA and Venturers

**Training References:** Scouts BSA Archery Merit Badge Pamphlet; Ranger Award Requirements on [Scouting.org](https://www.scouting.org).

**Equipment and Targets:** Age appropriate recurve or compound bows must be used.

Crossbows are not allowed. Manual and mechanical release systems are allowed. Any sighting systems can be used.

**Allowable arrows and targets:** All arrows must have target points. Requirements are set forth in the Merit Badge Pamphlet and Venturing Award materials. No zombie or humanoid targets are allowed.

Target butts can be made of any penetrable materials so arrows will partially penetrate but not go through the butt material. Synthetic, foam and natural materials can be used in the manufacture of butts.

**Range:** A range at an NCAP accredited camp property or a public or private commercial range or club.

Note that if using private property for the range location, the USA Archery Level 1 Instructor manual provides safety distance guidelines for outdoor range inspection prior to approving a location for an archery range.

**Training:** USA ARCHERY Level 1 Instructor or higher level instructor certification.

**Safety:** Arm-guards and finger tabs or gloves are required. If mechanical releases are used the finger tabs or gloves are not required.

**Range supervision:** A certified USA ARCHERY Level 1 Instructor or higher. Student to Instructor ratio is 8:1.

Here are the whistle commands.

- 2 whistle blasts – Go to the line
- 1 whistle blast – Shoot
- 3 whistle blasts – Retrieve Arrows
- 5 or more blasts – Emergency. Immediately stop shooting, return bows to the rack, and go behind the waiting line

### BEFORE YOUTH ARRIVE AT THE PROGRAM AREA

All archery equipment, targets, stands and the physical range must be inspected for safety and preparedness prior to any participant's arrival at the range.

### ON THE RANGE

- Bows, arrows, safety equipment and targets will be at each shooting position
- General staging areas for shooters and those waiting their turn are clearly marked including the Waiting Line, Shooting Line and Target Line.



## RANGE INSPECTION CHECKLIST

Inspected by \_\_\_\_\_ Date \_\_\_\_\_

√ = Yes

- Controlled access/fencing/gates closed
- Flags or signs displayed
- Range limits identified
- Backstop/impact area inspected
- Range lines/area marked
- Spectator area designated
- Supplies available
- First-aid kit filled/accessible
- Range rules posted
- Bulletin board available
- Bow racks available
- Empty trash receptacles available
- Lockable storage
- Arm guards and finger protection available
- Hand washing Station Available

### RANGE SAFETY BRIEFING

Note: This briefing is best done within viewing site of the range.

### ARCHERY SAFETY BRIEFING

- Safety is always #1
- To provide beginning shooters with Knowledge, Skill and Attitude (KSA) necessary to shoot a bow and arrow safely under direct supervision of a certified instructor.
- Archery range rules
  - Always walk on the range
  - Keep arrows in quiver until told to shoot
  - Only release the bow string when an arrow is nocked and safely pointed at the target
  - Leave dropped arrows on the ground until instructed to retrieve them
  - If there is an emergency on the range immediately alert the instructor
- Parts of a bow and parts of an arrow
- Demonstrate correctly nocking, drawing and shooting an arrow
- Shooting fundamentals
  - Stance
  - Nock
  - Hook and grip
  - Posture/Alignment
  - Raise bow
- Draw
- Anchor
- Transfer to hold
- Aim
- Release/follow through
- Feedback
- Explain range layout
  - Entrance/exit
  - Waiting Line
  - Shooting Line
  - Target Line
  - Safety Zones
  - Overshot areas
- Whistle commands
  - 2 whistle blasts – Go to the line
  - 1 whistle blast – Shoot
  - 3 whistle blasts – Retrieve Arrows
  - 5 or more blasts – Emergency. Immediately stop shooting, return bows to the rack, and go behind the waiting line.

**Before running a program check out the Range and Target Activities Webpage for updates to this program guide and find other resources.**



# APPENDIX 8 - INSTRUCTIONAL ARCHERY EXPERIENCE

## For Scouts BSA, Venturers And Sea Scouts

### INTRODUCTION

This guide is intended to provide units, districts and councils with an overview of the requirements for running the Archery program. All Scouting America Policies must followed and instructors are required to be certified as a USA Archery Level 1 Instructor. In this publication, you will find youth requirements and training requirements for adults who are providing archery programs. This program offers a fun and safe introduction to Archery.

### PROGRAM GUIDELINES

#### Youth Requirements

To participate in the archery program the following requirements must be met:

- Participants must be registered in Scouts BSA, Venturers or Sea Scouts
- Youth not registered in an official program must meet the required age guidelines to participate in a recruiting event.



### STANDARD OPERATING PROCEDURES

The standard operating procedures (SOPs) of the range should also be reviewed by USA Archery Level 1 Instructor before delivering this program. All equipment must be approved for use by the USA Archery Level 1.

### THE RANGE

An approved range can include:

- Scouting America Range at an NCAP accredited camp property
- Public Range
- Private Range
- Commercial range
- Private Property Range.

### ADULT SUPERVISION AND TRAINING REQUIREMENTS

1. Scouting America Youth Protection policies for two deep leadership must be maintained at all times.
2. Instructors must have current USA Archery Level 1 Instructor certification and be at least 18 years of age.

### APPLICABLE LAWS

Scouting America safety policies generally run parallel to or go beyond legal mandates. However, it is the camp or activity supervisor's responsibility to confirm and ensure compliance with all applicable federal, state, and local regulations or statutes related to youth using archery equipment.



## OPERATING PROCEDURES

The procedures outlined in the USA Archery Level 1 Instructor manual provides the guidelines for operating an indoor or outdoor archery range. All archery equipment used during the instructional shoot must be approved for use by the USA Archery Level 1 Instructor.

## THE RANGE

An approved range can include:

Scouting America Range at an NCAP accredited camp property  
Public or private commercial range  
Private property or club

Ranges must be set up under leadership of the USA Archery Level 1 Instructor.

## INSTRUCTIONAL ARCHERY SHOOTING EXPERIENCE

**Purpose:** Instruct youth in safe and fun archery shooting sports programs.

**Examples:** Scouts BSA Archery Merit Badge, USA Archery Level 1 or other recognized archery training. An instructional shooting experience could be held at an NCAP accredited camp property, public, private, commercial or club range.

**Youth:** Scouts BSA and Venturers

**Training References:** Scouts BSA Archery Merit Badge Pamphlet; Ranger Award Requirements (available on [Scouting.org](https://www.scouting.org)).

**Equipment and Targets:** Age appropriate recurve or compound bows must be used.

Crossbows are not allowed. Manual and mechanical release systems are allowed. Any sighting systems can be used.

**Allowable arrows and targets:** All arrows must have target points. Requirements are set forth in the Merit Badge Pamphlet and Venturing Award materials. No zombie or humanoid targets are allowed.

Target butts can be made of any penetrable materials so arrows will partially penetrate but not go through the butt material. Synthetic, foam and natural materials can be used in the manufacture of butts.

**Range:** A range at an NCAP accredited camp or a public or private commercial range or club. Note that if using private property for the range location, the USA Archery Level 1 Instructor manual provides safety distance guidelines for outdoor range inspection prior to approving a location for an archery range.

**Training:** USA ARCHERY Level 1 Instructor or higher level instructor certification for Merit Badge, USA Archery Level II Instructor is required for Level 1 instructor certification.

**Safety:** Arm-guards and finger tabs or gloves are required. If mechanical releases are used the finger tabs or gloves are not required.

**Range supervision:** A certified USA ARCHERY Level 1 Instructor or higher. Student to Instructor ratio is 8:1.

Here are the whistle commands.

- 2 whistle blasts – Go to the line
- 1 whistle blast – Shoot
- 3 whistle blasts – Retrieve Arrows
- 5 or more blasts – Emergency. Immediately stop shooting, return bows to the rack, and go behind the waiting line

## BEFORE YOUTH ARRIVE AT THE PROGRAM AREA

All archery equipment, targets, stands and the physical range must be inspected for safety and preparedness prior to any participant's arrival at the range.

## ON THE RANGE

- Bows, arrows, safety equipment and targets will be at each shooting position
- General staging areas for shooters and those waiting their turn are clearly marked including the Waiting Line, Shooting Line, and Target Line.

## RANGE INSPECTION CHECKLIST

Inspected by \_\_\_\_\_ Date \_\_\_\_\_

√ = Yes

- Controlled access/fencing/gates closed
- Flags or signs displayed
- Range limits identified
- Backstop/impact area inspected
- Ready lines/area marked
- Spectator area designated
- Supplies available
- First-aid kit filled/accessible
- Range rules posted
- Bulletin board available
- Bow racks available
- Empty trash receptacles available
- Lockable storage
- Arm guards and finger protection available
- Hand washing Station Available

### RANGE SAFETY BRIEFING

Note: This briefing is best done within viewing site of the range.

### ARCHERY SAFETY BRIEFING

- Safety is always #1
- To provide beginning shooters with Knowledge, Skill and Attitude (KSA) necessary to shoot a bow and arrow safely under direct supervision of a certified instructor.
- Archery range rules
  - Always walk on the range
  - Keep arrows in quiver until told to shoot
  - Only release the bow string when an arrow is nocked and safely pointed at the target
  - Leave dropped arrows on the ground until instructed to retrieve them
  - If there is an emergency on the range immediately alert the instructor
- Parts of a bow and parts of an arrow
- Demonstrate correctly nocking, drawing and shooting an arrow
- Shooting fundamentals
  - Stance
  - Nock
  - Hook and grip
  - Posture/Alignment
  - Raise bow
  - Draw
  - Anchor
  - Transfer to hold
  - Aim
  - Release/follow through
  - Feedback
- Explain range layout
  - Entrance/exit
  - Waiting Line
  - Shooting Line
  - Target Line
  - Safety Zones
  - Overshot areas
- Whistle commands
  - 2 whistle blasts – Go to the line
  - 1 whistle blast – Shoot
  - 3 whistle blasts – Retrieve Arrows
  - 5 or more blasts – Emergency. Immediately stop shooting, return bows to the rack, and go behind the waiting line.





# APPENDIX 9 - PISTOL SHOOTING

## Level 1: Pistol NRA FIRST Steps Pistol Orientation Shooting Experience

### INTRODUCTION

Pistol shooting is only approved as a council or district activity and may not be offered as a unit-level activity. This information is intended to provide councils with an overview of the requirements for running the NRA (National Rifle Association) FIRST Steps Pistol Orientation program.

The goal of the NRA FIRST Steps Pistol Orientation is to provide beginning shooters with an introduction to the knowledge, skills, and attitude necessary to own and use a specific pistol model safely.



### LENGTH OF ORIENTATION:

3 hours (all times listed are minimums). Additional time may be needed to meet the specified learning objectives using the NRA methodology of Total Participant Involvement. Lesson time must be increased proportionately to allow multiple participants to complete all specified activities.

### YOUTH REQUIREMENTS

Older Scouts BSA, Venturers and Sea Scouts 14 years of age or older, or 13 and have completed the eighth grade, may participate in this activity.



### PROGRAM GUIDELINES

#### APPLICABLE LAWS:

The safety policies of the Scouting America run parallel to or go beyond legal mandates. However, it is the NRA Range Safety Officer's responsibility to confirm and ensure compliance with all applicable federal, state, and local regulations or statutes related to youth handling and using a firearm.

#### PROGRAM OFFERED:

NRA FIRST Steps Pistol Orientation

#### REQUIRED NRA MATERIALS:

Councils offering the NRA FIRST Steps Pistol Shooting Orientation must provide each participant with an NRA Basic Pistol Student Packet (See current NRA Trainers' Catalog or [materials.nrahq.org](http://materials.nrahq.org) for pricing).

NRA Basic Pistol Student Packet (SKU: NR40830BS30612K) contents list:

- Gun Safety Rules Card
- NRA Basics of Pistol Shooting
- NRA Marksmanship Qualification Program Booklet

#### REQUIRED RANGE EQUIPMENT:

- Pistol
- Pistol owner's manual
- Dummy ammunition (must be visually distinguishable from live ammunition)
- An empty cartridge box for each pistol used
- An expended cartridge case for each pistol used
- Live ammunition (for use during live fire exercises on range ONLY)
- Hearing protection
- Eye protection
- Targets (see required target in the FIRST Steps Pistol Orientation Lesson Plan)
- Sandbags
- Benchrests (tables)
- Chairs
- Small screwdriver (for sight adjustments)
- Pistol cleaning equipment
- Lockable pistol case



## SAFETY:

Cartridge-firing pistol shooting requires eye protection and hearing protection. Air pistol shooting requires eye protection.

## FIREARMS PERMITTED:

Pistols and revolvers with calibers that are limited to .177 pellet pistol; .22 long rifle rimfire; .38 caliber special; or 9 mm only. Only one action may be demonstrated and used during the course. All firearms must be Council provided. Personally owned firearms may not be used.

## AMMUNITION:

The correct ammunition for the pistol being fired must be used. Only .177 pellet, .22 long rifle rimfire, .38 special and 9 mm are permitted. Tracer, armor-piercing, and explosive ammo are not allowed. Reloading ammunition and its use are not approved for Scouting America Range & Target Activities programs. All ammunition must be Council provided. Personally owned ammunition may not be used. An NRA Pistol Instructor must maintain control of the ammunition.

## STANDARD OPERATING PROCEDURES

**For council-managed ranges, the standard operating procedures (SOPs) should be reviewed and updated to reflect the requirements of delivering this program. A template for the SOP document may be found in Appendix of this manual.**



## COURSE OF SHOOTING FOR LESSON III (Live Fire Exercises)

### SINGLE-SHOT BENCHREST EXERCISE:

Supply participant with one cartridge at a time. Direct participant to “load.” When the participant is ready, direct them to “commence firing.” Then instruct participant to “cease firing” and unload. Have the participant fire five shots at the target. Observe participant closely. Watch the gun and shooter, not the target. Be sure all safety rules are followed. Offer guidance, direction, and positive feedback as appropriate. Involve the other participant (the “coach”) in the learning process by guiding him or her to watch the “pupil” and offer feedback under your direction. Repeat the single shot exercise for a total of 10 shots per student.

### MULTI-SHOT BENCHREST EXERCISE:

Supply participants with five cartridges at a time. Direct participant to “load.” When the participant is ready, direct them to “commence firing.” Be sure the participant rests between shots. After the five shots have been fired, instruct the participant to “cease firing” and unload. Repeat the multiple-shot exercise until your student can shoot “groups” anywhere on the target. Observe, offer feedback, and involve the other participant as in the single-shot exercise.

Repeat the multi-shot exercise until your student has been able to shoot at least three, five-shot groups within the NRA FIRST Steps Pistol Qualification Target. If you are using the coach/pupil method, have participants reverse roles and repeat the eight steps.

### SINGLE-SHOT TWO-HANDED STANDING EXERCISE:

Supply participant with one cartridge at a time. Direct participant to “load.” When the participant is ready, direct them to “commence firing.” Then instruct participant to “cease firing” and unload. Have the participant fire five shots at the targets. Observe participant closely. Watch the gun and shooter, not the target. Be sure all safety rules are followed. Offer guidance, direction, and positive feedback as appropriate. Involve the other participant (the “coach”) in the learning process by guiding him or her to watch the “pupil” and offer feedback under your direction. Repeat the single shot exercise for a total of 10 shots per student.

## **MULTI-SHOT TWO-HANDED STANDING EXERCISE:**

Supply participants with five cartridges at a time. Direct participant to “load.” When the participant is ready, direct them to “commence firing.” Be sure the participant rests between shots. After the five shots have been fired, instruct the participant to “cease firing” and unload. Repeat the multiple-shot exercise until your student can shoot “groups” anywhere on the target. Observe, offer feedback, and involve the other participant as in the single-shot exercise.

Repeat the multi-shot exercise until your student has been able to shoot at least three, five-shot groups within the NRA FIRST Steps Pistol Qualification Target. If you are using the coach/pupil method, have participants reverse roles and repeat the eight steps.

## **RANGE**

Pistol programs will only be available as a council/district activity and all practical instruction must take place on a Scouting America authorized camp range or a commercial firearms range.

A “commercial firearm range” is a supervised facility that offers a controlled environment for safe firearm practice. It will provide shooting lanes, targets, and may offer equipment rentals and training in safe firearm handling and marksmanship. Standard operating procedures are required for each firearm type used on-site. Scouting’s range and target activities must follow all of Scouting’s range and target activities policies or range standard operating procedures that are equivalently stringent, including no variation from Scouting’s limitations on firearms used. These ranges may be operated by a licensed business, a government entity or a nonprofit.

## **ADULT SUPERVISION AND TRAINING REQUIREMENTS**

**NRA PISTOL INSTRUCTOR & NRA RANGE SAFETY OFFICER RANGE SUPERVISION RATIO:**  
An NRA certified Pistol Instructor shall supervise the classroom instruction. Range supervision shall be undertaken on a 1:1 ratio with NRA Pistol Instructors who are not Assistant or Apprentice NRA Pistol Instructors, and one NRA Range Safety Officer or NRA Chief Range Safety Officer per six or fewer shooters.

## APPENDIX 10 - MULTIGUN AIRSOFT EXPERIENCE

### ACKNOWLEDGEMENTS

Scouting America, in cooperation with the National Rifle Association, is proud to present the Multi-Gun Airsoft Experience, a fun recreational program for new and intermediate shooters. This guide is a Scouting America adaptation of the *NRA 3 Gun Experience Guidebook*. Scouting America greatly appreciates the NRA for their continuing commitment and contributions to Scouting.

Multi-Gun Airsoft Experiences offer a great introduction to the fastest growing shooting sport in the world, 3 Gun. These safe, family-friendly events can help councils reach new members and retain existing ones.

No council, district, or unit is authorized to host, demonstrate, or otherwise present any sort of airsoft program unless the policies and procedures in this *Operations Guide* are followed.

### INTRODUCTION

Airsoft uses plastic 6-millimeter spherical balls that are sometimes called airsoft BBs or pellets. Airsoft guns use compressed gas or a spring or electric motor to drive air out of the gun to propel the BBs. Airsoft guns come in two authorized formats: rifle and shotgun.

The Multi-Gun Airsoft Experience differs from most range activities in that all participants use one or both types of the airsoft guns. Note that fully automatic use of airsoft guns is prohibited. Airsoft guns that have a “select fire” capability must remain in semi-automatic or safe mode at all times.

Each individual shooter is paired with an instructor in their own dedicated shooting bay. A coach may also assist the shooter using the coach/pupil method. All shooting is done from a standing position except to accommodate shooters with special needs.



### A WORD ABOUT SAFETY

While every attempt has been made in this guide to outline a fun and safe program, those efforts cannot replace review and vigilance at the point of program execution.

The [Event Safety Checklist](#) in the *Guide to Safe Scouting* and the [Program Hazard Analysis](#) found in the [Scouting Safely](#) section on [Scouting.org](#) can assist local operators in discussing safety conditions specific to their area.

Safety is integrated into the program by design but is not necessarily called out as such. This includes range layouts, limitations on the guns used, and requirements for eye protection as well as the need for qualified supervisors who know and understand the equipment being used.

This *Operations Guide* contains the program in its entirety. Multi-gun activities outside of these parameters have not been evaluated and are not considered official Scouting activities.

This operations guide will be revised occasionally as changes are made to equipment, operation, and technology, so please keep an eye out for updates. The latest version is available [online](#).

### SCOUTING AMERICA-AUTHORIZED AIRSOFT ACTIVITY

All councils, districts, and units are required to follow the specifications in this guide when sponsoring or conducting Multi-Gun Airsoft Experiences. Districts and units are prohibited from using airsoft guns unless permission is provided by their council. This program may only be offered on an NCAP accredited camp property or at a commercial range.

The use of airsoft is not authorized in the Cub Scout program.

\* Districts must receive permission from the council Scout executive, or authorized delegate, and the council range and target activities committee before conducting any events involving airsoft guns. Permission is granted on a calendar-year basis and is good for all district-sponsored events to be conducted that year.

\*\* Units must receive permission from their district executive and the council range and target activities committee before conducting any event involving airsoft guns. Permission is granted on a per-event basis.

### REQUIRED STAFF

Volunteers, coaches, and instructors are vital to the success of a Multi-Gun Airsoft Experience. It takes a good team to accomplish a successful event—several people handling registration, managing logistics, and, of course, overseeing range operations. The operations staff (below) must include: The **airsoft volunteer** is needed to set up the range and also to help with cleanup after the event. Volunteers also assist in managing participants in and out of the range and oversee all non-shooting, non-instructional activities.

AIRSOFT ROLE	AGE	MINIMUM CERTIFICATIONS REQUIRED	HOW MANY
Volunteer	14+	None	As needed for the event
Coach	14+	Authorized by airsoft instructor	1 Per bay as authorized
Airsoft instructor	18+	NRA instructor or National Camping School certified Range Activities Director bb-gun Rangemaster plus airsoft endorsement	1 Per bay

The **airsoft coach** should be present with the participant in the bay. Using the coach/pupil method, the coach must always remain behind or within arm’s reach of the participant; this ensures that they can take immediate physical control of the airsoft gun from the participant if required. If a malfunction occurs, the participant must immediately cease fire and transfer control of the airsoft gun to the coach. Airsoft coaches—with the approval of the airsoft instructor—may reload airsoft guns.

The **airsoft instructor** is qualified in the safe use, care, and operation of airsoft pistols, rifles, and shotguns, and has been so endorsed. This endorsement is provided by the council hosting the airsoft event and is only good within that council. The endorsement must be renewed anytime there is a change in the make/model of airsoft guns or a significant change in the operation of the Multi-Gun Experience format. The council Scout executive or their authorized delegate provides this endorsement. Any person applying for the endorsement must be at least a qualified BB-gun Rangemaster as defined in the *National Range and Target Activities Manual*; Appendix 5 provides the list of requirements. An airsoft instructor must conduct any required training before a participant can enter a bay with the airsoft coach.

The instructor may be appointed to sign off on all required documentation and applications to authorize the event. An instructor may serve as a coach. If no other coach is available, the instructor assumes the role.

### AIRSOFT RANGE LAYOUT

The Scouting America Multi-Gun Airsoft Experience is designed for an individual participant to shoot multiple guns, one at a time, at a given set of targets in a single bay. One or more bays, a waiting area, and an optional training area make up the complete airsoft range. Range design guidelines for the Multi-Gun Airsoft Experience can be downloaded from <https://www.scouting.org/outdoor-programs/properties/resources/design-guidelines/>.

### RANGE DESIGN

Each bay is designed to accommodate one participant and their coach in addition to the targets and airsoft guns with containers. It is recommended that you have a 10-foot-high backstop and ballistic cloth sidewalls on the right and left that connect with the backstop. The sidewalls must be at least 8 feet high to ensure the safety of others and structures surrounding the shooting area.

A safe minimum shooting distance (SMSD) of no less than 15 feet between airsoft guns and targets should be established to minimize the effects of ricochets to shooters, staff, and observers. This distance may be increased depending on the target materials in use and the velocity of the airsoft gun BBs. If multiple bays are used, they must be designed to prevent any risk of injury if someone is resetting targets downrange in an adjacent bay. These recommendations assume a maximum target height of 4.5 feet.

### SINGLE-BAY DESIGN

The range design guidelines online at [scouting.org](https://www.scouting.org) has a sample single-bay design in which pistol, rifle, and shotgun airsoft guns are used and there is a dedicated shooting lane for each type of gun. Each lane is set between the container for a particular gun and the targets intended to be shot by that gun.

All spectators must remain behind the control line. Up to five participants who are next in line may be positioned between the ready line and control line. Anyone stepping forward of the control line must wear eye protection. Some type of highly visible and elevated barrier (e.g., rope or a fence) should be positioned at the control and side barriers with closable entrances as needed to manage entry into various areas of the range. Raised barriers with gates at the bay and ready lines are also suggested if you anticipate a lot of participants.

### MULTIPLE-BAY DESIGN

The range design guidelines online at [scouting.org](https://www.scouting.org) also shows a sample range with multiple bays. Note the suggested dedicated training area for first-time shooters



and traffic flow. Each bay in a multi-bay range layout is operated independently of the others, and ballistic cloth sidewalls are required to prevent crossfire between the bays. Each bay must have its own instructor and shooting sequence. Once a participant is trained for a course of fire, repeat training at the same event is at the discretion of the instructor. Participants could be given wristbands or another indicator so they may be easily identified as “trained.” A separate training area may be established for single- or multiple-bay layouts.

An airsoft pistol, rifle, or shotgun is placed on the shooting table when a bay is ready for a course of fire. The gun must have the safety on and be pointing downrange. After shooting is completed, the gun must be placed in a container next to the shooting station; the ideal container is a plastic, non-marring barrel or trashcan where the guns are placed muzzle down. In the case of pistols it may be more appropriate to have a smaller container on a table. To help reduce damage, a soft cloth or pillow may be used in the container where the gun will be placed. If the muzzle cannot be placed in a down position it must be pointing downrange in a safe direction. Airsoft guns must have the safety engaged when in the container.

Obstacles within a bay are optional and provide a challenge as participants move from one shooting lane to another. If participants must go around an obstacle they must always go around the end farthest from the targets—toward the bay line. Participants must not cross over or under obstacles. Obstacles must not be taller than 4 feet above the ground to ensure there are no line-of-sight obstructions within the bay.

The backstop and walls should be constructed of material that will not allow airsoft BBs to penetrate them when fired from any distance.

Targets should be “responsive”—providing some sort of visual and/or audible indicator when struck. They can be made of materials to cause a sound (e.g., metal) or constructed so they will visibly move when hit. Moving or auto-resetting targets used for pellet guns or firearms usually will not work for airsoft because the BBs lack enough force to cause much movement.

## SELECTING AND BUILDING TARGETS

When planning your event, make sure that the targets selected are appropriate for the range layout and the equipment being used.

Questions to consider when choosing targets:

- What is the safe minimum shooting distance participants will be shooting from?
- How many shooters do you anticipate will attend?
- What is the specific type and style of airsoft gun that will be used? If you construct the targets instead of purchasing them from a vendor, any solid

material will work—Plexiglas, sheet aluminum, and plywood are a few possibilities. Base your choice and the construction on the purpose each target will serve. If a target will be used multiple times, it should be easy to clean quickly between rounds. If you want it to fall on impact, the only requirement is that the target body be hinged at the base. Pay careful attention to the angle of the target to be sure that none of the airsoft BBs will travel back toward the firing line or outside the bay. This appendix offers an example of how to build a simple sheet-metal target.

## PLANNING THE COURSE OF FIRE

An airsoft instructor should plan each *course of fire*—the sequence of actions that take place inside a bay. This sequence must include the start and end locations of the participant and coach as well as the shooting order of guns at each shooting lane and the number of shots per lane. To assist in this process, see Appendix 3 for a list of commonly used range commands and view the range design guidelines online for a single-bay range layout with three shooting lanes.

Typically, the participant and coach begin at the starting station as defined by the airsoft instructor who designed the course of fire. The instructor is in control of the bay and will provide commands to commence and cease fire. At the instructor’s command the participant and coach will walk or run to the first shooting lane immediately behind the gun container. The participant then retrieves the airsoft gun from the table (always keeping the gun pointed in a safe direction), assumes a proper shooting stance, aims, disengages the safety, and proceeds to fire the prescribed number of shots at that station. The airsoft gun is then made safe and put back in the container. This sequence continues until all lanes have been visited or a “cease fire” command is given. When a participant and coach complete their last shooting lane, they go to the end station and await further instruction.

The airsoft coach remains immediately behind the participant at all times to ensure safe operation of each gun. The coach has the authority to call “cease fire” and to regain control of the gun. The coach is responsible for reloading the gun if empty and helping participants if they have difficulty operating the gun action (e.g., cycling a pump shotgun). *At no time may a participant reload an airsoft gun.*

When planning the multi-gun course, remember that the sequence of gun formats (pistol, rifle, shotgun) can be in any order—as decided by the airsoft instructor—if you are using self-resetting targets. If the targets reset manually, the course of fire should move from bay to bay so targets can be reset in one bay while another is active. The setup of a course is at the discretion of the airsoft instructor and is only limited by the range being utilized.

## SHOPPING FOR AIRSOFT GUNS

When purchasing guns for the Multi-Gun Airsoft Experience, consider the intended use, cocking force, and accuracy level, as well as how much you plan to spend. Remember that this is not a high-precision sport but, rather, it is intended for youth and novice shooters. You will want to make sure that the guns are affordable, reliable, and can withstand long periods of shooting. Do not be afraid to contact the manufacturers if you have specific questions.

Scouting America-approved airsoft guns are listed in this appendix. All Airsoft guns must resemble rifle or shotgun models that are Scouting America approved and are age appropriate. Your selections should be determined by the budget available, operating characteristics of the airsoft guns, and the number of expected participants.

You will need to budget for miscellaneous items such as clipboards, shot timers or stopwatches, spray paint, eye protection, stakes and rope, trash cans and foam for placing empty guns at the end of a course of fire, tables, canopies, chairs, signage, and building supplies for barricades.

**Note:** By registering your Multi-Gun Airsoft Experience as an NRA Day Event, you can receive 50 T-shirts, 15 staff hats, gun safety rules cards, lapel pins, the *Winchester/NRA Marksmanship Qualification Program Book*, and as many participant and staff certificates as you need. The application fee is \$20.00. For more information visit <https://nraday.nra.org/Web/HostEvent.aspx> or call 1-800-672-7435, option 1.

## NRA FOUNDATION GRANTS

Consider applying for an NRA Foundation Grant to obtain different types of guns and support materials for your event.

The NRA Foundation is a 501(c)(3) tax-exempt organization that raises tax-deductible contributions to support qualified educational, training, and developmental programs. The *Friends of NRA* program raises money through dinners and auctions. Half of the monies raised

are utilized by The NRA Foundation nationally, with the other half used for grants to qualified organizations in the state in which the money was raised. Each state has a *Friends of NRA* State Fund Committee that reviews grant applications and recommends grant funding to The NRA Foundation's board of trustees for final review. For more information about grants or to apply online, visit <http://nrafoundation.org/apply-for-a-grant.aspx> or contact The NRA Foundation at (800) 423-6894.

## RELEASES

Advice from local legal counsel should be sought on the development of statements pertaining to event liability waivers, assumption of risk statements, and/or hold harmless agreements.

## EVENT PREPARATION

Establish well in advance the range layout and a list of volunteers and what they will be doing. Meet with all people who will serve in staff roles (airsoft instructors, coaches, etc.) and ensure they have adequate certification and training.

Be sure all airsoft guns are in working order and that backup guns are available. Have plenty of ammunition and supplies on hand. If new equipment or supplies must be purchased, ensure that vendors are contacted early to provide enough lead time for delivery, inspection, and any required training of staff.

Use the [Scouting America Event Checklist](#) to ensure all aspects of the event are considered.

The Program Hazard Analysis (PHA) Narrative and the PHA Matrix documents can be reviewed, discussed, and approved by the council's Enterprise Risk Management Committee.

Finally, advertise and market the Multi-Gun Airsoft Experience event and register with NRA's Recreational Shooting Department!

## APPENDIX 10.a

### GLOSSARY

**AIRSOFT GUNS.** Pneumatic gun replicas that function like real guns, used for training and recreation. They may be electric or powered by gas or spring action.

**AIM.** The process of aligning the gun with the target, usually by means of the sights.

**BACKSTOP.** A structure made to stop or collect the projectiles that hit it.

**BAY.** A square or rectangular area that is surrounded by two sidewalls and a backstop.

**BALLISTIC CLOTH.** A thick, tough, synthetic nylon fabric that is used to stop or slow down projectiles that hit it. Used as a backstop for airsoft.

**BARRICADE.** A structure or object for shooting from or behind. It may be used to aid or challenge the shooter's ability to make the shot.

**BERM.** A large pile of dirt on an outdoor shooting range that functions as a backstop.

**BOLT.** The mechanism in some guns that holds the cartridge in place during the firing process.

**CEASE FIRE.** To stop firing and remain in position. The muzzle must be pointed downrange with the finger removed from the trigger. The mechanical safety on each shooter's rifle is placed on "safe," the "cease fire" command is repeated to be sure all have heard it, and everyone waits for further instructions from the Range Safety Officer.

**CONTAINER.** A barrel, bucket, or other container that holds the airsoft gun when not in use.

**COURSE OF FIRE.** A predetermined instruction as to how and where the shots will be taken.

**DOWNRANGE.** The direction toward the target area of the range, where guns are pointed when they are fired.

**EXTERNAL SAFETY.** Accessible safety devices on the outer surface of a gun.

**FIRING LINE.** An imaginary or marked line from which shooters fire downrange. In an airsoft bay there may be separate firing lines for each gun station.

**LANE.** The shooting area between the airsoft gun and targets.

**MAGAZINE.** A device for holding ammunition ready for loading into the chamber of a repeating gun.

**MUZZLE.** The end of the barrel where the airsoft BB exits the gun.

**NO-SHOOT TARGET.** A downrange target that is painted red or black and should not be engaged. If a no-shoot target is shot it is a procedural penalty.

**RANGE IS COLD.** The phrase used when the firing line is safe and people may move freely about the range. Guns must not be handled when anyone is ahead of a lane firing line.

**RANGE IS HOT.** The phrase used when shooters are on the firing line preparing to shoot. Protection is worn and non-authorized persons must remain in the ready line behind the shooters.

**SAFE MINIMUM SHOOTING DISTANCE.** The smallest distance between target and airsoft gun to minimize the effects of ricochets to shooters, staff, and observers. For rifles, this distance is recommended to be no less than 20 feet. For pistols and shotguns, this distance should be no less than 15 feet.

**SELF-RESETTING TARGET.** A target designed with springs, weights, or wires so it will reset to the original stance after being shot.

**SEMI-AUTOMATIC.** A gun designed to fire shots and reload each time the trigger is pulled.

**SHOOTING PROTECTION.** Eye protection (mandatory) and ear protection (optional).

**STAGE.** A segment in an event program with its own course of fire, time limits, and target layout. Multiple stages may be incorporated into an event.

**STAND BY.** A command given to the shooter to wait with gun loaded and safety on. The command to start the course of fire will be given verbally or by a shot timer.

**TARGET ENGAGEMENT.** A specified sequence in which targets will be shot, usually set by the course of fire in the event program or by the event director.



## APPENDIX 10.B

### FREQUENTLY ASKED QUESTIONS

#### WHAT TYPES OF TARGETS ARE USED WITH AIRSOFT GUNS?

In the Scouting America program, airsoft guns may not be pointed at any living thing. Only paper, plastic, metal, or other suitable targets may be used. Care must be taken to ensure suitable backstops and targets must be arranged so there is no damage to nearby humans, animals, plants, or structures.

#### ARE FULLY AUTOMATIC AIRSOFT GUNS ALLOWED?

No. Fully automatic fire, shooting more than once per single pull of the trigger, is prohibited. If the airsoft gun has the ability to shoot in fully automatic and semi-automatic mode, only semiautomatic mode is permitted. Airsoft guns that are only fully automatic are prohibited. Please note airsoft shotguns that shoot multiple airsoft BBs per single pull of the trigger are not considered fully automatic.

#### WHAT MODELS OF AIRSOFT GUNS MAY BE PURCHASED OR USED BY SCOUTING AMERICA ORGANIZATIONS?

Appendix 10G lists by manufacturer and model the only airsoft guns and accessories permitted in Scouting America. No other types are permitted regardless of similarity.

#### WHAT IS THE BAY?

An airsoft bay is a protected area or zone with multiple targets to accommodate one participant and one airsoft coach. Targets may be set up for each type of gun being shot in that bay. If multiple bays are used, each must be adequately secured so that participants and coaches can retrieve or reset their targets in other bays without risk of being hit by an airsoft BB.

#### IS SPECIAL SAFETY EQUIPMENT REQUIRED FOR AIRSOFT ACTIVITIES?

All people within a bay and everyone within the control area as determined by the instructor must wear adequate eye protection. Hearing protection is not required but may be worn by those sensitive to the noise of an airsoft gun. As with all Scouting activities, proper clothing including footwear must be worn at all times.

#### WHO MAY PARTICIPATE IN SCOUTING AMERICA MULTI-GUN AIRSOFT EXPERIENCE EVENTS SPONSORED BY COUNCILS AND DISTRICTS?

All participants must have a sufficient level of maturity and physical dexterity to safely operate an airsoft gun. The use of an airsoft pistol, rifle, or shotgun is left to the discretion of the airsoft instructor and council policies. All participants must receive training in the safe handling and operation of an airsoft gun before use. If they cannot demonstrate safe handling or operation they are not allowed to use the airsoft gun.

#### MAY UNITS CONDUCT A MULTIGUN AIRSOFT EXPERIENCE EVENT?

Scouts BSA troops, Venturing crews, Sea Scout ships, and Exploring posts may conduct a full Multi-Gun Airsoft Experience. Any unit conducting one of these events must have all required personnel as defined in this guide. The unit should get confirmation from its district executive and the council range and target activities committee before conducting any event involving airsoft guns. Permission is granted on a per-event basis.



## APPENDIX 10.C

### SAFETY BRIEFING

All participants must go through a safety briefing at the start of any Scouting America Multi-Gun Airsoft Experience. The briefing should be about five minutes long to avoid losing the participants' attention. Be sure to cover each of the five main areas in this NRA sample briefing:

#### 1. PURPOSE OF THE EVENT

Introduce yourself and the staff. Inform all shooters about the course of fire and emphasize that the event is for new and intermediate shooters.

#### 2. RANGE LAYOUT AND LIMITS

- Explain the range setup and point out where the spectator area is located. There should also be a holding area where participants can wait for their turn to shoot.
- Show the participants which targets are designated for each gun they are shooting.

#### 3. SAFETY RULES AND SITE SPECIFIC RULES

- Demonstrate how to operate each airsoft gun.
- **ALWAYS** keep the gun pointed in a safe direction.
- **ALWAYS** keep your finger off the trigger until ready to shoot.
- **ALWAYS** keep the gun unloaded until ready to use.
- Cover site-specific rules as needed.

#### 4. FIRING LINE COMMANDS

Firing commands must be simple and clear. Ensure that all participants know and understand what is meant and what is expected of them. Depending on the range environment, make use of a loud speaker system to clearly communicate with those on the firing line. A possible firing command sequence might proceed as follows:

- A. "Range is hot."
- B. "Shooter, do you understand the course of shooting?" (Answers yes or no.)
- C. "Make ready."
- D. "Are you ready?" (Yes or no.)
- E. "Shooter indicates they are ready."
- F. "Stand by."
- G. "Start" or timer tone.
- H. Stage ends when last shot fired.
- I. "Time."
- J. Time is read from timer.
- K. "Range is cold."
- L. Command to staff only: "Reset stage."

#### 5. EMERGENCY COMMANDS AND PROCEDURES

"Stop."

"Cease fire."

In the event of an emergency, all shooting must cease. All staff must be aware of the emergency plan.

## APPENDIX 10.D

### FIRST AID AND EMERGENCY PLANNING

No one wants an injury or emergency to occur during an event, so preparation is crucial. If your range does not have a first-aid kit, one should be purchased and placed in a central location accessible to everyone. You may also set up a designated first-aid station or ask a local rescue squad to have a trained paramedic at your event if none of your instructors or volunteers are certified in first aid and CPR.

You may have an emergency plan already in place, but if not, all staff and volunteers should review the steps for responding to an emergency. Be sure they all know the location of the first-aid kit or the people responsible for administering first aid.

Establish procedures to be followed in case of an emergency:

- Take charge of the situation.
- Call for help, if required.
- Render aid within your scope of training.
- Direct responders to the location.
- Take notes for a report.



## APPENDIX 10.E

### AIRSOFT ENDORSEMENT

A person is entitled to an airsoft endorsement by their council if they demonstrate the following to the council shooting sports director or their authorized representative.

- Present a current BB-Gun Rangemaster certification or any NRA instructor certification. An NRA Range Safety Officer certification is not sufficient because this is not equivalent to an NRA instructor rating.
- Know and explain the three Fundamental Rules for Safe Gun Handling.
- Know and explain the fundamental operation of battery-, gas-, and spring-powered airsoft guns.
- For each Scouting America-approved airsoft gun type demonstrate the following:
  - How to put the gun on “safe” and take it off
  - How batteries are changed in an electric gun
  - How a gas-powered gun is recharged
  - How to cycle the action of a spring-powered gun
  - How to load airsoft BBs into the gun
  - How to unload the BBs if the gun is already loaded
  - The proper holding of an airsoft gun
  - The proper airsoft shooting position while standing
  - How to aim and fire an airsoft gun (requires a safe location). A full range of gun formats is not required.
  - How to change magazines and cartridges (e.g., multi-BB shotgun shells, CO2 gas) if so equipped
- Explain a typical airsoft bay layout and the importance of each component.
- Explain targets that are suitable for different types of airsoft guns.
- Explain airsoft BBs.
- Explain the different airsoft roles:
  - Participant
  - Coach
  - Instructor
- Demonstrate in a simulated shooting environment how an airsoft coach and participant would conduct a course of fire in a typical Multi-Gun Airsoft Experience.
- Explain or demonstrate when it is necessary to take physical control of an airsoft gun from the participant.

The airsoft endorsement, once earned, is valid for two years. An endorsement card (No. 33767/SKU 615012) shall be issued and signed by the council range and target activities chair or their authorized representative. The training code is S100/Multi-Gun Airsoft Training.

## APPENDIX 10.F

### APPROVED VENDORS

#### AIRSOFT SUPPLIERS

##### AIRSOFT GI

1077 Commerce Pointe Drive  
Walnut, CA 91789  
Company phone 909-869-0671  
Website: [www.airsoftgi.com](http://www.airsoftgi.com)  
Scouting America liaison: Ed Gatti, 804-909-7380;  
[edwardg@airsoftgi.com](mailto:edwardg@airsoftgi.com) or Frank Chu, 909-869-0671,  
[manager@airsoftgi.com](mailto:manager@airsoftgi.com)

##### AIRSOFT MEGASTORE

100 N. Providence Road, Unit A  
Chesterfield, VA 23235  
Phone: 818-495-6502  
Email: [support@airsoftmegastore.com](mailto:support@airsoftmegastore.com)  
Website: [www.airsoftmegastore.com](http://www.airsoftmegastore.com)

##### PYRAMYD AIR

5135 Naiman Parkway  
Solon, OH 44139  
Phone: 888-262-4867  
Fax: 216-896-0896  
Email: [sales@pyramydair.com](mailto:sales@pyramydair.com)  
Website: [www.pyramydair.com](http://www.pyramydair.com)

##### C.A.T. COMMAND AIRSOFT TECHNOLOGIES

125 Wes Walker Memorial Drive  
Ball Ground, GA 30107  
Phone: 770-704-7949  
Fax: 770-720-7861  
Email: [sales@catairsoft.com](mailto:sales@catairsoft.com)

##### CROSMAN

7629 Routes 5 & 20  
Bloomfield, NY 14469  
Phone: 1-800-7AIRGUN (724-7486)  
Website: [www.crosman.com](http://www.crosman.com)

#### TARGET MANUFACTURERS

##### TACTRAINERS

2012 Downrange Blvd.  
Fresno, CA 93720  
Phone: 559-451-1132  
Email: [instructor@tactrainers.com](mailto:instructor@tactrainers.com)  
Website: [www.tactrainers.com](http://www.tactrainers.com)

## APPENDIX 10.G

### PERMITTED AIRSOFT GUNS AND ACCESSORIES

<b>AIRSOFT SHOTGUNS</b>
Airsoft shotgun models used for this program must resemble a model that would be age-appropriate and Scouting America approved for normal shotgun shooting.
<b>AIRSOFT BOLT ACTION RIFLES</b>
Airsoft rifle models used for this program must resemble a model that would be age-appropriate and Scouting America approved for normal bolt-action rifle shooting.

## APPENDIX 10.H

### SAMPLE AIRSOFT TARGET CONSTRUCTION

The targets for the Scouting America Multi-Gun Airsoft Experience can be simple yet effective in construction. This example consists mainly of 1¼-inch PVC components and a simple sheet-metal target that can be cut at any local metal shop. Targets may be constructed in 2-, 3-, or 4-foot heights. The metal target face can be cut in three uniform sizes: 3-inch circle, 4-inch circle, or a 4½× 6-inch rectangle; the sizes are modeled to scale to simulate the sight picture of current NRA 3 Gun Experience or Steel Challenge targets. Each target should be cut with a 1" × 1" square tab on the perimeter that can bend at a 90-degree angle for mounting to the main beam of the target stand.

ITEM	QTY	PRICE
1¼" X 10' SCHEDULE 40 PVC PIPE	1	\$5.00
1¼" FIVE-WAY PVC FURNITURE FITTING	1	\$3.10
1¼" PVC CAP	5	\$3.00
* 16-GAUGE STEEL TARGET	1	\$2.40
4" METAL BAR	1	MIN
NUT/SCREW	2	MIN
NUT/BOLT	1	MIN
<b>TOTAL PER TARGET</b>		<b>\$25.50</b>

\*The 16-gauge steel targets can be manufactured at any local metal fabrication shop in three uniformed sizes (3" circle, 4" circle and 4½" x 6" rectangle).The sizes are modeled to scale to simulate the same sight picture of current NRA 3 Gun Experience or Steel Challenge targets.

1. Cut a 4-foot piece from the PVC pipe to serve as the main target beam.

2. Cut four 1-foot pieces of PVC and place a cap on one end of each piece.

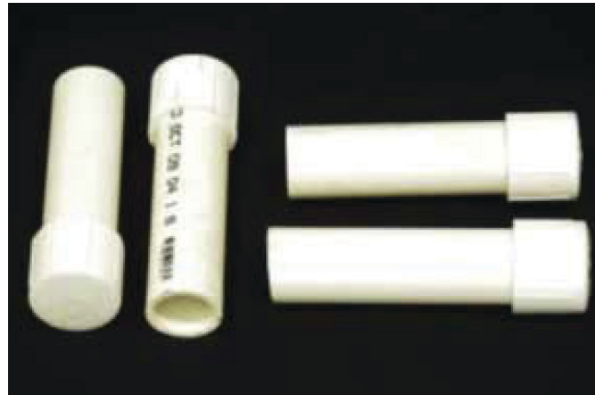

3. Place the four capped pieces inside the four perpendicular openings of the PVC furniture fitting.





4. Insert the main target beam into the remaining opening of the five-way connector. You can add weight for stability by filling the bottom of the stand with sand or other material. If even more stability is required, put the base in a large planter pot and then fill the pot with sand or gravel.



5. To attach the target face, start by drilling two holes into the bent 1" × 1" tab. Then drill two corresponding holes into the 4-inch metal bar and affix the target to the bar with two screws secured by nuts. It is **IMPORTANT** not to tighten the nuts against the target: Leaving the nuts loose will allow the target to tilt backward when it is hit. Then the BBs travel downward, preventing them from ricocheting back to the firing line. A dab of metal adhesive such as Loctite will prevent the screw from backing too far off during use.

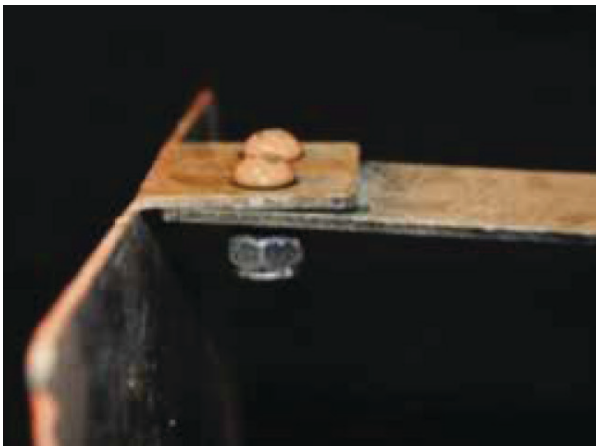

6. Drill a hole in the opposite end of the metal bar and secure it to the remaining PVC cap with a nut and bolt.



7. Attach the PVC cap to the main beam to complete the target construction.



# APPENDIX II - CHALK BALL PROGRAM GUIDE

## CONTENTS

### 191 INTRODUCTION

191 Youth Requirements

191 Adult Supervision and Training Requirements

191 Program Guidelines

191 Standard Operating Procedures

### 193 APPENDIXES

193 Appendix 11a: Sample Range Safety Rules

194 Appendix 11b: Sample Chalk Ball Course  
Inspection Checklist

194 Appendix 11c: Chalk Ball Course Safety Briefing

## INTRODUCTION

This guide is intended to provide councils and districts with an overview of the requirements for running the chalk ball program. This is not a unit-level activity and must not be conducted as one. In this publication, you will find youth requirements, training requirements for adults who are providing the program, and sample budgets for running this program in camp and weekend program venues. Range design guidelines can be downloaded from <https://www.scouting.org/outdoor-programs/properties/resources/design-guidelines/>.

The chalk ball program is intended to provide a special and unique experience for Scouts BSA and Venturers who are attending summer camp or weekend programming. Scouts will have an opportunity to shoot chalk ball markers at various targets. Youth are given 100 chalk/paint balls and move through a course with specific rules regarding safe handling of the markers and operational equipment. The goal of the program is to teach safe handling, responsibility, and marksmanship through a fun activity. **Either chalk balls and paintballs may be used for this program.**

This program does not use the LaPorte throwing system and should not be confused with the flashball program that uses LaPorte equipment.



## YOUTH REQUIREMENTS

This program is for youth in the Scouts BSA program. Youth in the Venturing and Sea Scout programs may also participate. Cub Scout-age youth are not allowed to participate.

## ADULT SUPERVISION AND TRAINING REQUIREMENTS

Scouting America Youth Protection policies for two-deep leadership must be maintained at all times. All course personnel involved in the chalk ball shooting program are required to have current certifications and ratings in the roles they will be performing on the course at that time.

An NRA Range Safety Officer (RSO) is in charge of the entire field and will conduct the safety briefing and give range calls as required.

## PROGRAM GUIDELINES

### APPLICABLE LAWS

Scouting America safety policies generally run parallel to or go beyond legal mandates. However, it is the camp or activity supervisor's responsibility to confirm and ensure compliance with all applicable federal, state, and local regulations or statutes related to youth handling and using a paintball marking gun.

### SCOUTING AMERICA GUIDELINES

This is a Level 2 shooting sports activity and must follow all guidelines in the *National Range and Target Activities Manual*, No. 430-938.

### STANDARD OPERATING PROCEDURES

Before beginning this program, a program hazard analysis should be conducted for the range and this program as outlined in National Camp Accreditation Program standard PD-111 ([www.scouting.org/ncap](http://www.scouting.org/ncap)). The enterprise risk management committee for the council should review the analysis as per standard PD-112. The program hazard analysis instructions and template can be found at <https://www.scouting.org/health-and-safety/forms/>.

Your range Standard Operating Procedures should also be reviewed and updated to reflect the requirements for delivering this program. A template for range standard operating procedures is located in Appendix 3 of the *National Range and Target Activities Manual* if you do not already have them for your range.



## **RUNNING THE PROGRAM**

The chalk ball course is made up of aluminum horizontal spinning targets, vertical spinning targets, and cowbells. The range has shooting positions with significant separation between each position. Two shooters shoot at separate and parallel targets at a time.

The chalk ball course is a series of targets presented in differing distances and types of targets, allowing the shooter to test their skills at differing sight pictures.

The shooting course has shooting positions capable of handling two shooters at a time. The range has signage and barriers, allowing containment of shoots, and it bars unauthorized people from entering the shooting area.

### **RANGE EQUIPMENT LIST**

- Four paintball markers
- 15 plastic chalk ball containers
- 16 masks
- 10 metal targets
- One radio
- Six cowbell targets
- Two carrying boxes for markers
- One first-aid kit
- Two 50-pound CO<sub>2</sub> cylinders
- Eight 20-ounce CO<sub>2</sub> canisters

## **BEFORE YOUTH ARRIVE AT THE PROGRAM AREA**

- All markers, ammunition, and targets are provisioned during nonprogram times by maintenance and support personnel in sufficient quantity to run the program for all shooters without interruption.
- Face masks and goggles should be cleaned between each shooter.
- Range staff will assist the RSO by putting up targets, preparing markers, staging chalk/paint balls to the preparation table, and setting up shooting positions along the course.
- General staging areas for shooters and those waiting their turn are clearly marked and include a well-defined path along the course so shooters and range staff can easily travel, carrying the markers and maintaining safe gun-handling rules.

## **WHEN YOUTH ARE PRESENT IN THE PROGRAM AREA**

- Welcome youth to the area and begin the chalk ball safety briefing found in the appendix of this guide.
- Each shooter will be accompanied by range staff, who will be actively involved in every shot and all marker handling.
- Range staff members are responsible for the adherence to safety rules and commands provided by the range safety officer at ALL TIMES. They will oversee the shooting, sighting, and exception situations (such as cease-fires) on the course for the shooter.
- Range staff members carry the markers between each set of shooting positions. Markers are kept on safety and pointed downrange at all times. Between shooting stations, markers are carried in a box by the range staff.
- At the first shooting position, youth load the hoppers using a plastic container of chalk/paint balls they were given during the safety briefing. Give instructions that this is enough “ammo” to have a number of shots at each target.

## APPENDIX II.A

### SAMPLE RANGE SAFETY RULES

The chalk ball range rules governing marker safety are listed below.

- **ALWAYS** keep the marker pointed downrange.
- **ALWAYS** keep your finger off the trigger until ready to shoot.
- **ALWAYS** keep the marker unloaded until ready to use.

In addition to those rules, there is a set of guidelines necessary for the safe operation of the course:

- The course should NEVER be opened without a working radio or alternate working communications device on the premises.
- A first-aid kit that is well-stocked and in good repair will be available in a public location for everyone to see and use.
- Storage of markers and chalk/paint balls will be in separate lockable cabinets. The keys and combinations for those cabinets will be under the control of the course operations range staff.
- The course must be walked one time per day to establish that the perimeter is safe and that the safety signs are still in place.
- All markers and chalk/paint balls will be secured before personnel leave the course for any reason.
- The filling of canisters is to be performed only by a competent adult familiar with the process. Heavy gloves and eye protection are to be worn at all times while filling canisters.
- Range staff members are the only personnel allowed on the firing line of the course with the shooters, unless the range safety officer gives specific permission.
- All shooters must wear eye protection at all times while on the course.
- During any CEASE-FIRE, all firing positions will stop shooting, put their marker on safety, keep the muzzle pointed downrange, and wait for additional instructions.
- At no time should the muzzle of any marker be pointed above the berm.
- Targets are of various types (spinning and stationary) and are intended to give varying “sight pictures” to Scouts.
- Any ammunition dropped on the ground or found on the ground should be left there.
- When the marker runs out of chalk/paint balls, the shooter is done, no matter how far along the course they may be.
- No food or drink is allowed on the course.
- The use of tobacco and alcohol products is forbidden on the course.
- In the event of a health or safety emergency, the Range Safety Officer is responsible for managing the event. If they are not able to do so, the lead range staff member will be responsible.
- In the event of a health issue, contact camp leadership personnel via radio, and they will direct your actions from that point until resolution.
- Unruly behavior and unsafe actions will result in a warning from the range staff. In the event of repeated misbehavior, the range staff may at their discretion remove the shooter from the course for the day. No refunds of fees are necessary in the event of a removal from the course.
- In the event of a Scout being shot with a chalk/paint ball, the shooter and the “hitee” are banned from the course for the remainder of the program.
- At any time that thunder is heard or lightning is seen, the course must be shut down and no shooting will occur until 30 minutes after such observation is made.
- Only shooters and course personnel are allowed on the firing line during a firing sequence without specific permission from the range staff.

## APPENDIX II.B

### SAMPLE CHALK BALL COURSE INSPECTION CHECKLIST

Inspected by \_\_\_\_\_ Date \_\_\_\_\_

√ = Yes

- Controlled access/fencing/gates closed
- Flags or signs displayed
- Left and right range limits displayed
- Backstop/impact area inspected
- Lumber boards painted and visible
- Target frames/mounts in good repair
- Ready line/area marked
- Spectator area designated
- Scoring area established
- Supplies available
- Range staff control area centralized
- System/bullhorn working
- First-aid kit filled/accessible
- Course rules posted
- Bulletin board hung
- Marker racks available
- Empty trash receptacles available
- Storage lockable

## APPENDIX II.C

### CHALK BALL COURSE SAFETY BRIEFING

#### GENERAL

- Explain that the shooting device is a paintball “marker,” not a paintball “gun.”
- Go over the basic components of the marker: hopper, CO<sub>2</sub> canister, and sights.
- Explain that chalk/paint balls are loaded into the hopper.
- Describe the chalk/paint balls. They have a hard, waxy exterior with powder inside and dimpling on the outside. State that any chalk/paint balls on the ground must be left there because they may have already been shot and weakened.
- Point out that CO<sub>2</sub> is the propellant, the tank may get cold while shooting, and the tanks may need to be switched out during shooting.
- Explain that the sight is a basic iron sight. Adjust aiming based on the last shot because the sight is not adjustable.
- Clearly state that the mechanical safety must be on at all times unless the marker is aimed downrange and ready to shoot. Black means the safety is engaged; red means that the safety is off. Do not rely solely on the safety. Keep the barrel pointed at the ground or downrange at all times. Do not point the marker at anything not downrange or at anyone. Keep your finger off the trigger until ready to shoot.
- Pass out eye protection, which should be worn at all times on the course, even when not shooting.
- Take any questions.

## QUALIFICATIONS

When markers are used during the briefing, the Range Safety Officer must follow the NRA gun safety rules.

### 1. PURPOSE OF THE SHOOTING EVENT

- Tell participants that they will engage in chalk/paint ball shooting on the course.
- Explain that each marker will be loaded with 100 chalk/paint balls.
- Demonstrate the safe loading and unloading of each marker they will use.
- Each participant will shoot a total of 100 chalk/paint balls. Instruct them to shoot short bursts at each target and conserve the chalk/paint balls so they can hit each target.
- Range staff will be at each shooting station to provide guidance and instruction. The role of range staff and the RSO is to provide a safe environment for the shoot.

### 2. COURSE LAYOUT AND LIMITS

- Point out and describe the course layout and explain what stations will be used and which markers will be shot at each station.
- Describe the firing line for each target and explain what the purpose is. Explain when shooters are expected to be at each line.
- Spectators are not allowed on the course and should remain in the staging area until the Scouts return from shooting.

### 3. COURSE SAFETY RULES

Three fundamental NRA rules for safe marker handling:

Ask: What is the first rule of safe marker handling?

—Always keep the marker pointed in a safe direction.

Ask: What does a “safe direction” mean?

—The marker is pointed so that even if it were to go off, it would not cause injury.

Ask: What is the second rule of safe marker handling?

—Always keep your finger off the trigger until ready to shoot.

Ask: Unless shooting, where should the shooter’s finger(s) rest?

—The finger(s) should rest alongside the marker, i.e., on the frame, receiver, or trigger guard.

Ask: What is the third rule of safe marker handling?

—Always keep the marker unloaded until ready to use.

Emphasize that safeties can fail. Safe marker handling rules should be followed all the time!

## Rules for safe use

*Know your target and what is beyond.*

Ask: What is meant by “know your target and what is beyond”?

—The shooter must be sure that projectiles will safely hit the backstop.

*Be sure the marker is safe to operate. Know how to use the marker safely.*

Ask: What is meant by “know how to use the marker safely”?

—Shooters need to know how the marker operates, its basic parts, how to safely open and close the action, and how to remove ammunition.

*Use only the correct ammunition for your marker.*

Ask: What is meant by “use only the correct ammunition”?

—Only ammunition designed for a particular marker can be safely fired in that marker

—Shooters should ensure that the chalk ball/paintball matches the marker size.

**.50 caliber balls only.**

*Wear eye protection as appropriate.*

Ask: Why should course users wear eye protection?

—Markers can also emit debris, gas, and broken chalk balls that could cause eye injuries.

*Never use alcohol or drugs before or while shooting.*

Ask: What type of substance is implied by “never use alcohol or drugs”?

—It refers to any substance that may impair normal mental or physical bodily functions.

## General course safety rules

Ask course users to read rules as you (range staff) point to course posters or refer to handouts.

—Know and obey all course commands.

—Know where others are at all times.

—Shoot only at authorized targets.

—Do not handle a marker while others are downrange.

—Stop shooting immediately upon the command of “cease firing.”

Ask: Why is it important to shoot only at authorized targets?

—Shooting at different targets, e.g., steel targets, at different distances or angles may result in hazardous conditions.

Ask: What actions should shooters perform during a cease-fire?

—Stop shooting immediately.

—Await further instructions from the range staff.

### **NRA hygiene guidelines**

- —Wash your hands and face with cold water after leaving the course or cleaning area before eating or drinking.

Ask: Why are shooters required to leave dropped ammunition on the ground?

- This policy prevents shooters from unintentionally pointing the marker at other users while retrieving dropped ammunition, or inadvertently moving in front of the firing line.

### **4. FIRING LINE COMMANDS**

State and explain standard course commands that will be used for chalk ball:

- “Commence firing!” signals shooters to begin shooting.
- “Cease firing!” notifies shooters to stop firing immediately and wait for further instructions.

Ask: Who can call a cease-fire?

- Anyone on the range who sees something unsafe.
- “Course is clear” means all markers are benched.

### **5. EMERGENCY PROCEDURES**

- Take charge of the situation. (Determine the seriousness of an injury and assign duties.)
- Render aid. A first-aid kit should be centrally located.
- Call for help via radio.
- Direct help to your location.

# APPENDIX 12 - COWBOY ACTION SHOOTING PROGRAM GUIDE

## CONTENTS

197	<b>INTRODUCTION</b>
197	Youth Requirements
197	Adult Supervision and Training Requirements
198	Program Guidelines
198	Standard Operating Procedures
199	Running the Program
200	<b>APPENDIXES</b>
200	Appendix 12a: Sample Cowboy Action Range Inspection Checklist
201	Appendix 12b: Sample Cowboy Action Scenarios
201	Appendix 12c: Cowboy Action Safety Briefing

## INTRODUCTION

This guide is intended to provide councils and districts with an overview of the requirements for running the Cowboy action shooting program. This is not a unit-level activity, and it should not be conducted as one. In this publication you will find youth requirements, training requirements for adults who are providing the program, and sample budgets for camp and weekend program venues. Plans for building the program area facilities are included in the appendix.

The program offers a fun and safe introduction to Cowboy action shooting with pistols, rifles, and shotguns. Eligible Scouts can take part in a special shooting experience with opportunities to shoot single-action .22-caliber pistols, lever-action .22-caliber rifles, and 12-gauge or 20-gauge shotguns.

In various old-time western scenarios, Scouts play “good guys” who prove their accuracy by shooting at things like spinning metal targets where they hit the spinner to “ring the bell.” All shooters choose their own Cowboy action names before starting so the NRA instructors—dressed in cowboy attire—can call them by those names.

## YOUTH REQUIREMENTS

Scouts BSA, Venturing and Sea Scout members who are over the age of 14, or are 13 and have completed the eighth grade, may participate in this activity.

## ADULT SUPERVISION AND TRAINING REQUIREMENTS

Scouting America Youth Protection policies for two-deep leadership must be maintained at all times.

The Cowboy action shooting program can be conducted only by NRA-certified instructors with pistol, rifle, and/or shotgun certifications (must have all three if using all three types of firearms). Each Cowboy action shooting participant will be accompanied by a certified pistol, rifle, or shotgun instructor (depending on the firearm being used) who is actively involved in every shot and all of the gun handling. All Range Safety Officers and instructors for this program must possess current credentials for the discipline they will be instructing.

- Range Safety Officers (RSOs) must have current certification from the NRA.
- Instructors must have a current rating of pistol, rifle, or shotgun instructor from the NRA.





## PROGRAM GUIDELINES

### APPLICABLE LAWS

Scouting America safety policies generally run parallel to or go beyond legal mandates. However, it is the camp or activity supervisor's responsibility to confirm and ensure compliance with all applicable federal, state, and local regulations or statutes related to youth handling and using a firearm.

### SCOUTING AMERICA GUIDELINES

This is an "open shooting experience," or level 2 according to the five levels of range and target activities. All guidelines in this manual must be followed.

Lever-action rifles have been approved for use in this program only and should not be used in other Scouting programs.

## STANDARD OPERATING PROCEDURES

Before beginning this program, a program hazard analysis should be conducted for the range and this program as outlined in National Camp Accreditation Program standard PD-111 ([www.scouting.org/ncap](http://www.scouting.org/ncap)). The enterprise risk management committee for the council should review the analysis as per standard PD-112. The program hazard analysis instructions and template can be found at [www.scouting.org/health-and-safety/forms](http://www.scouting.org/health-and-safety/forms).

The standard operating procedures (SOPs) of the range should also be reviewed and updated to reflect the requirements for delivering this program. A range SOP sample can be found in this manual.

### RANGE DESIGN

This program is intended to give youth an Old West "cowboy" shooting experience. The range should be specifically designed to provide the Old West look and feel. Range designs can be downloaded from <https://www.scouting.org/outdoor-programs/properties/resources/design-guidelines/>.



**3D VIEW - FRONT**  
NO SCALE

### COWBOY ACTION SHOOTING PAVILION



**3D VIEW - REAR**  
NO SCALE



## RUNNING THE PROGRAM

### BEFORE YOUTH ARRIVE

The program provides a fun immersion in old-time shooting scenarios where youth take on the persona of the “good guy,” shooting at targets to prove their shooting accuracy. Sample scenarios are in this guide. You can adapt these samples for your camp or come up with your own scenarios that relate to the history of your area.

If metal targets are used, ensure that the targets are properly angled and at a proper distance so that all metal splatter hits the ground away from participants and instructors.

All firearms, ammunition, and targets are set up during non-program hours by maintenance personnel in sufficient quantity to run the program for all shooters without interruption. Only council-owned firearms and ammunition can be used for this program.

Instructors will assist the NRA Range Safety Officer in putting up targets, placing firearms on the firing line, staging ammunition on the preparation table, and setting up shooting positions and Cowboy action scenery.

General staging areas for shooters and those waiting their turn are clearly marked and include a red “ready” line behind each shooting position. As shooters enter, they stand behind the line and await the command to move to the shooting position.

### WHILE YOUTH ARE IN THE ACTIVITY AREA

- Each shooter in the Cowboy action shooting program will have a certified pistol, rifle, or shotgun instructor, depending on the shooting position. The instructor will be actively involved in every shot and all of the gun handling at that station. Qualified instructors should be stationed at each position prior to youth beginning the shooting experience.
- The pistol, rifle, or shotgun will be loaded by the instructor prior to the shooter arriving at the shooting position.
- Instructors are responsible for adhering at ALL TIMES to safety rules and the commands provided by the NRA Range Safety Officer.
- Each instructor will oversee their shooter’s unloading, shooting, and sighting on the range, as well as exceptional situations such as cease-fires.
- Before moving to their shooting positions, all youth must participate in a Cowboy action shooting safety briefing as outlined in this appendix.. The course of fire—option 1 or 2 below—should be determined before the briefing by the person in charge of shooting sports for the camp or activity. The course of fire must be clearly explained during the briefing so that participants understand what they are to do at each station, and when and where they are to move.

- After the briefing, each shooter will choose their own Cowboy action name so the NRA instructors, dressed in cowboy attire, may call them by these names.
- Cowboy scenery for four different shooting positions will be located on the walkway of the western-style structure.

### COURSE OF FIRE OPTION 1

- The shooter starts at the left shooting station (shooting position 1), placing their hands on the shelf until commanded by the RSO to commence firing.
- Once the RSO has given the firing command, the shooter picks up the lever-action rifle, fires six rounds at spinning rifle targets, opens the action, and then sets down the rifle.
- The shooter then moves to the first window (shooting position 2), picks up the first pistol, and fires six rounds at a flatiron pistol target. When finished, the shooter opens the cylinder loading gate and sets down the pistol.
- Then the shooter moves to the second window (shooting position 3), picks up the second pistol, fires six rounds at another flatiron target, and repeats the procedure of opening the cylinder loading gate and setting down the pistol.
- The shooter now moves to the right end of the structure (shooting position 4), picks up the shotgun, and fires two shots at a ground target. When finished, the shooter ejects the shells and sets down the shotgun.
- Finally, the shooter walks back to the ready line. When the RSO has given the “all clear” command, the next shooter can move to the ready position.

### COURSE OF FIRE OPTION 2

- The shooter starts at the left shooting station (shooting position 1), placing their hands on the shelf until commanded by the RSO to commence firing.
- Once the RSO has given the firing command, the shooter picks up the lever-action rifle, fires six rounds at spinning rifle targets, opens the action, and then sets down the rifle.
- Then the shooter, remaining at the left end of the structure, picks up the pistol and fires six rounds at a pistol target. When finished, the shooter opens the cylinder loading gate and sets down the pistol.
- The shooter now moves to the right end of the structure (shooting position 4), picks up the shotgun, and fires two shots at a ground target. When finished, the shooter ejects the shells and sets down the shotgun.
- The shooter then walks back to the ready line. When the RSO has given the “all clear” command, the next shooter can move to the ready position.

## APPENDIX 12.A

### SAMPLE COWBOY ACTION RANGE INSPECTION CHECKLIST

Inspected by \_\_\_\_\_ Date \_\_\_\_\_

√ = Yes

- Controlled access/fencing/gates closed
- Flags or signs displayed
- Left and right range limits displayed
- Backstop/impact area inspected
- Lumber boards painted and visible
- Target frames/mounts in good repair
- Firing line marked
- Firing points numbered/clean
- Shooting benches/tables inspected
- Sandbags/gun rests on hand
- Ready line/area marked
- Spectator area designated
- Scoring area established
- Supplies available
- NRA RSO control area centralized
- Emergency communications working
- First-aid kit filled/accessible
- Range rules posted
- Bulletin board hung
- Gun racks available
- Empty trash receptacles available
- Brass/dud buckets labeled
- Trash area identified
- Lockable storage

## APPENDIX 12.B

### SAMPLE COWBOY ACTION SCENARIOS

These scenarios are provided as suggestions. You should change the names and places to fit your camp or make up your own scenario to fit the history of your area.

#### SCENARIO 1

Mayor V. Augustine has seen Bad Bob Gibbens and his Baldnobbers Gang crossing Bow Creek! The mayor ordered Marshal Larry Maly to get a posse and stop Bad Bob's band from holding up Uncle Kev Rittel's Trading Post. (Bad Bob has a terrible hankerin' for them slushies that Kev serves up there.) Marshal Maly has deputized you to keep the Baldnobbers out of the trading post.

#### SCENARIO 2

Ranger Rex and Popcorn Patty were crossing the plains of Kirwin when they stopped their wagon outside of Greg's Trading Post. They were stocking up on fixin's for those famous covered-wagon turkey sandwiches. Next thing they knew, the Tom W. Turkey Gang had surrounded the store. These gobblers were tired of being hunted and were out to take prisoners. They started to tie up and gag Ranger Rex so he couldn't make turkey sandwiches for the Scouts. But Popcorn Patty grabbed her Dutch oven to clobber those thieving gobblers, and screamed for help. Sheriff Slim Maly and Deputy Greenback Greg came a'running, rallying a posse to fend off the Tom W. Turkey Gang.



## APPENDIX 12.C

### COWBOY ACTION SAFETY BRIEFING

**Note: This briefing is best done within viewing range of the Cowboy action shooting range. When firearms are used during the briefing, the NRA RSO must follow the NRA gun safety rules.**

Cowboy action shooting consists of shooting multiple shots from a loaded .22-caliber lever-action rifle, a .22-caliber single-action pistol, and a 12- or 20-gauge shotgun at non-human form action targets in an Old West setting.

Have participants read the NRA "Range Safety Rules" poster.

Review the NRA's three "Fundamental Rules for Safe Gun Handling" (verbatim), and discuss general range rules (see below). Ask questions for reinforced learning.

### PURPOSE OF THE SHOOTING EVENT

- Tell participants that they will engage in Cowboy action recreational shooting on the range.
- Explain that they will shoot a total of 14 rounds—six from the pistol, six from the rifle, and two from the shotgun. (Note: Those totals are for option 2; revise the numbers if using option 1.)
- A trained instructor will be at each shooting station to provide guidance and instruction. The role of each instructor and the NRA RSO is to provide a safe environment for the shoot.

### RANGE LAYOUT AND LIMITS

- Point out and describe the range layout, and explain what stations will be used and which guns will be shot at each station.
- Describe the ready line and firing line. Explain the purpose of the lines and when shooters are expected to be at each line.
- Inform everyone that the spectator line is located behind the ready line. This is where all non-shooters will remain until authorized to enter the range.

### HOW THE SHOOTING EVENT WORKS

Have one instructor demonstrate the course of fire option that has been selected, without using a loaded gun or live fire. Be sure to cover how shooters will move through the course and handle shooting at each station. (See course of fire descriptions on pages 6 and 7 of this guide.)

## SAFETY RULES

### Three fundamental NRA rules for safe gun handling:

Ask: What is the first rule of safe gun handling?  
— Always keep the gun pointed in a safe direction.

Ask: What does a “safe direction” mean?  
— The gun is pointed so that even if it were to go off, it would not cause injury.

Ask: What is the second rule of safe gun handling?  
— Always keep your finger off the trigger until ready to shoot.

Ask: Unless shooting, where should the shooter’s finger(s) rest?  
— The finger(s) should rest alongside the gun, i.e., on the frame, receiver, or trigger guard.

Ask: What is the third rule of safe gun handling?  
— Always keep the gun unloaded until ready to use.

Emphasize that safeties can fail. Safe gun-handling rules should be followed all the time!

### Rules for safe use

*Know your target and what is beyond.*

Ask: What is meant by “know your target and what is beyond”?  
— The shooter must be sure that projectiles will safely hit the backstop.

*Be sure the gun is safe to operate.*

*Know how to use the gun safely.*

Ask: What is meant by “know how to use the gun safely”?  
— Shooters need to know how the firearm operates, its basic parts, how to safely open and close the action, and how to remove ammunition.

*Use only the correct ammunition for your gun.*

Ask: What is meant by “use only the correct ammunition”?  
— Only ammunition designed for a particular gun can be safely fired in that gun.  
— Shooters should ensure that the caliber marked on the barrel, ammo box, and cartridge case match. This is especially true for antique firearms.

*Wear eye and ear protection as appropriate.*

Ask: Why should course users wear eye and ear protection?  
— Guns are loud and the noise can cause hearing damage. Guns can also emit debris, hot gas, and cartridge cases that could cause eye injuries.

*Never use alcohol or drugs before or while shooting.*

Ask: What type of substance is implied by “never use alcohol or drugs”?  
— It refers to any substance that may impair normal mental or physical bodily functions.

## GENERAL RANGE SAFETY RULES

Have all range users read the rules as the NRA RSO points to range posters or refers to handouts.

- Know and obey all range commands.
- Know where others are at all times.
- Shoot only at authorized targets. Also, note that shooting at different targets at different distances or angles can result in hazardous conditions.
- Do not handle a firearm or stand at the firing line where firearms are present while others are down-range.
- Stop shooting immediately upon the command to “cease fire,” and await further instructions from the NRA RSO.

## NRA HYGIENE GUIDELINES

Explain that the following NRA hygiene guidelines can minimize one’s exposure to airborne lead particles and cleaning product residues. Emphasize that these guidelines apply even to non-shooters exposed at the range or cleaning area because they, too, can be affected.

- Wash your hands and face with cold water after leaving the range or cleaning area, and before eating or drinking.
- Change and wash clothing after shooting or cleaning a gun to minimize exposure to airborne lead particles, cleaning product residues, or solvent.
- Leave dropped ammunition on the floor until the course of fire is completed and firearms are benched or grounded. This policy prevents shooters from unintentionally pointing the firearm at other users while picking up the ammunition, or moving in front of the firing line.
- Notify the NRA RSO when there is a firearm stoppage malfunction.
- Dry firing is permitted only at the firing line and only when authorized.
- All firearms must remain unloaded with actions open except when the guns are on the firing line and authorized to be loaded.
- When firearms are benched or grounded, keep the actions open and the ejection ports facing upward so the chambers are visible.
- Ammunition is not permitted in the cleaning area.

## **FIRING LINE COMMANDS**

Explain the standard range commands for Cowboy action shooting:

“Is the line ready?” allows any shooter who is having problems to raise an arm and call, “Not ready on target (number)!”

“Commence firing!” signals shooters to begin shooting.

“Cease firing!” tells shooters to immediately stop firing and await further instructions. This command can also be given by shooters if they observe an unsafe condition.

“Range is clear” means all guns are benched.

“Police your firing point” means to pick up empty cartridges.

## **EMERGENCY PROCEDURES**

- Take charge of the situation. (Determine the seriousness of any injuries and assign duties.)
- Render aid. The first-aid kit should be centrally located.
- Call for help via radio.
- Direct help to wherever it is needed.



# APPENDIX 13 - INSTRUCTIONAL RIFLE EXPERIENCE

## For Scouts BSA, Venturers And Sea Scouts

### INTRODUCTION

This guide is intended to provide units, districts and councils with an overview of the requirements for running the shooting program ensuring all Scouting America Policies are followed under NRA Certified Rifle Instructor and NRA Range Safety Officer (RSO). In this publication, you will find youth requirements, training requirements for adults who are facilitating a safe handling Rifle instruction program for youth.

### PROGRAM GUIDELINES

#### Youth Requirements

Registered Scouts BSA members, Venturers or Sea Scouts and youth who are age appropriate participating in a Rifle instructional curriculum designed to develop and improve shooting skills.



### STANDARD OPERATING PROCEDURES

The standard operating procedures (SOPs) of the range should also be reviewed by NRA Range Safety Officer before delivering this program. All firearms must be approved for use by the NRA Range Safety Officer.

### THE RANGE

An approved range can include:

- Scouting America Range at an NCAP accredited camp
- Commercial range.

### ADULT SUPERVISION AND TRAINING REQUIREMENTS

1. Scouting America Youth Protection policies for two deep leadership must be maintained at all times.
2. Instructors must have current certification as an NRA Instructor.
3. RSO must have current certification as an NRA Range Safety Officer (RSO).

### APPLICABLE LAWS

Scouting America safety policies generally run parallel to or go beyond legal mandates. However, it is the camp or activity supervisor's responsibility to confirm and ensure compliance with all applicable federal, state, and local regulations or statutes related to youth handling and using a firearm.

### INSTRUCTIONAL SHOOTING SPORTS PROGRAM

**Purpose:** Teach youth the Knowledge, Skill and Attitude (KSA) of safe handling of a Rifle by participation in a formal Rifle shooting curriculum.

**Examples:** Examples of instructional programs are the Scouts BSA Rifle Shooting Merit Badge and the Venturing Ranger Award. Shooting programs could be held at a Scouting America national accredited camp property, public, or commercial range.

## Youth: Scouts BSA, Venturers, Sea Scouts

- .22 caliber rimfire, bolt-action rifle. Either a breech-loading, single-shot, bolt-action or a repeater bolt action with a box magazine can be used. Tubular or high-capacity magazines are not allowed. If magazines are used, the range commands must include “magazines out after firing all rounds” to ensure the firing line is safe after all shots are fired. This now means a Scout can load more than one round directly into the box magazine to shoot. The trigger pull will be 3 pounds or greater.

Lever action and tubular magazine rifles are approved for use in the Cowboy Action Program ONLY.

**Ammunition:** Correct ammunition for the rifle being fired. Tracer, armor-piercing, and explosive ammunition are not allowed.

### **Reloaded ammunition is not approved for Scouting America programs.**

**Range:** A range at a Scouting America accredited camp property or a commercial range.

**Instruction for Scouts BSA members:** NRA Basics of Rifle Shooting Course (eight hours), Rifle Merit Badge. Taught only by an NRA Rifle Instructor.

**Instruction for Sea Scouts and Venturers:** Sea Scout Shooting Sports, Venturing Ranger Award or NRA Basics of Rifle Shooting Course (eight hours). Taught only by an NRA Rifle Instructor.

**Required for Scouts BSA members:** Scouting America Rifle Safety Briefing in this document.

**Required for Sea Scouts and Venturers:** Scouting America Rifle Safety Briefing in this document.

**Instruction References:** Scouts BSA Rifle Merit Badge Pamphlet; [Download Ranger Award Requirements](#)

**Safety:** ANSI Z87.1-2010 certified eye protection and appropriate hearing protection is required.

**Range supervision:** A certified NRA Range Safety Officer is to directly supervise all live fire on the range. Additionally a currently certified NRA Rifle Instructor must provide support to the shooters during live fire. These must be two separate individuals.

**Ratio:** One NRA Range Safety Officer (1:8) must be present for each group consisting of a maximum of eight shooters. One NRA certified Rifle Instructor per eight active (1:8) shooters is required when loading and firing a Rifle.

**Course:** Scouts BSA Merit Badge: Using a .22 caliber rimfire rifle and shooting from a bench rest or supported prone position at 50 feet, fire five groups (three shots per group) that can be covered by a quarter.

**Course for Sea Scouts and Venturing:** [Download Ranger Award Requirements](#)

**NRA Basic Rifle Shooting Course:** Shooting activities are described in the course lesson plans. NRA Winchester Qualification Program: Use this program to recognize success as shooters progress.

### **Sample Range commands**

- “Eye and ear protection on”
- “Shooters to the ready line.”
- “Shooters to the firing line”
- “Is the line ready?”
- “Load.”
- “Ready on the firing line.”
- “Commence firing.”
- “Cease fire.”
- “Remove magazines”

## **BEFORE YOUTH ARRIVE AT THE PROGRAM AREA**

All Rifles, ammunition, and targets are provisioned in sufficient quantity to run the program for all shooters without interruption during non-program times by maintenance and support personnel.

### **ON THE RANGE**

- Eye and ear protection should be cleaned between each shooter.
- Range staff will assist the NRA RSO and Instructor by preparing rifles, ammunition to the preparation table, and setting up shooting positions on range.
- General staging areas for shooters and those waiting their turn are clearly marked and safe gun handling rules posted.

**People in program areas adjacent to the firing line must wear ear protection if measured sound levels are 85 dB (decibel) or above.**

## **WHEN YOUTH ARE PRESENT IN THE PROGRAM AREA**

Welcome youth to the area and begin the gun handling safety briefing. NRA Range Safety Officer (RSO) is responsible for all activities on the range.



## RANGE INSPECTION CHECKLIST

Inspected by \_\_\_\_\_ Date \_\_\_\_\_

√ = Yes

- Controlled access/fencing/gates closed
- Flags or signs displayed
- Range limits identified
- Backstop/impact area inspected
- Ready line/area marked
- Spectator area designated
- Supplies available
- First-aid kit filled/accessible
- Range rules posted
- Bulletin board available
- Rifle racks available
- Empty trash receptacles available
- Lockable storage
- Throwers available and loaded
- Eye and ear protection available
- Hand washing Station Available

## Range Safety Briefing – Rifle

- No LIVE Ammunition in the classroom!
- To provide beginning shooters with Knowledge, Skill and Attitude (KSA) necessary to shoot a Rifle safely under supervision of a certified instructor.
- 3 Rules of Gun Safety
  - Always keep your gun pointed in a safe direction
  - Always keep your finger off the trigger until ready to shoot
  - Always keep your gun unloaded until ready to use.
- Parts of a Rifle
- Demonstrate Rifle operation
  - Loading dummy rounds
  - Cocking
  - Dry Fire
  - Unloading
- Shooting Fundamentals
  - Dominant Eye
  - Position
  - Shooting Fundamentals
    1. Aiming
    2. Hold Control
    3. Breath Control
    4. Trigger Control
    5. Follow-through
- Range Layout
  - Ready Area
  - Firing Line
  - Target Area
  - Back Stop
- Other Safety Rules
  - Know your target and what is beyond
  - Eye and Ear Protection
  - No alcohol or drugs
  - Proper hygiene
  - Clean up after shooting
- Range Commands
  - “Eye and ear protection on”
  - “Shooters to the ready line.”
  - “Shooters to the firing line”
  - “Is the line ready?”
  - “Load.”
  - ”Ready on the firing line.”
  - “Commence firing.”
  - “Cease fire.”
  - “Remove magazines”

Before running a program check out the Range and Target Activities Webpage for updates to this program guide and find other resources.

For questions or additional information, contact the National Service Center at [outdoorprograms@scouting.org](mailto:outdoorprograms@scouting.org)

## APPENDIX 14 - OPEN RIFLE EXPERIENCE

### For Scouts BSA Members, Venturers And Sea Scouts

#### INTRODUCTION

This guide is intended to provide units, districts and councils with an overview of the requirements for running the shooting program ensuring all Scouting America Policies are followed under NRA Certified Rifle Instructor and Range Safety Officer (RSO). In this publication, you will find youth requirements, training requirements for adults who are providing the program for camp and weekend program venues. The program offers a fun and safe introduction to safe handling of a rifle.

#### PROGRAM GUIDELINES

##### Youth Requirements

Registered Scouts BSA members, Venturers or Sea Scouts, and youth who are age-appropriate participating in a Council, District or Unit organized Rifle Shooting activity conducted as part of a weekend campout, camporee or similar event.



#### STANDARD OPERATING PROCEDURES

The standard operating procedures (SOPs) of the range should also be reviewed by NRA Range Safety Officer before delivering this program. All firearms must be approved for use by the NRA Range Safety Officer.

#### THE RANGE

An approved range can include:

- Scouting America Range at an NCAP accredited camp
- Commercial range.

#### ADULT SUPERVISION AND TRAINING REQUIREMENTS

1. Scouting America Youth Protection policies for two deep leadership must be maintained at all times.
2. Instructors must have current certification as an NRA Instructor
3. RSO must have current certification as an NRA Range Safety Officer (RSO).

#### APPLICABLE LAWS

Scouting America safety policies generally run parallel to or go beyond legal mandates. However, it is the camp or activity supervisor's responsibility to confirm and ensure compliance with all applicable federal, state, and local regulations or statutes related to youth handling and using a firearm.

## OPEN RIFLE SHOOTING SPORTS EXPERIENCE

**Purpose:** Teach youth the Knowledge, Skill and Attitude (KSA) of safe handling of firearm in a range and target activities.

**Examples:** A day-at-the-range event (fun shoot), Venturing or Sea Scout event, NRA Day event (contact the National Association for information on NRA Day), Winchester/NRA Marksmanship Qualification Program, camporee, camp weekend shoot, or Order of the Arrow event are examples.

**Youth:** Scouts BSA members, Venturers, Sea Scouts

- .22 caliber rimfire, bolt-action rifle. Either a breech-loading, single-shot, bolt-action or a repeater bolt action with a box magazine can be used. Tubular or high-capacity magazines are not allowed. If magazines are used, the range commands must include “magazines out after firing all rounds” to ensure the firing line is safe after all shots are fired. This now means a Scout can load more than one round directly into the box magazine to shoot. The trigger pull will be 3 pounds or greater.

Lever action and tubular magazine rifles are approved for use in the Cowboy Action Program ONLY.

**Ammunition:** Correct ammunition for the rifle being fired. Tracer, armor-piercing, and explosive ammunition are not allowed.

**Reloaded ammunition is not approved for Scouting America programs.**

**Range:** A range at a Scouting America accredited camp property or a commercial range.

**Required for Scouts BSA members:** Scouting America Rifle Safety Briefing in this document.

**Required for Sea Scouts and Venturers:** Scouting America Rifle Safety Briefing in this document. Safety. ANSI Z87.1-2010 certified eye protection and appropriate hearing protection is required.

**Range supervision:** A certified NRA Range Safety Officer is to directly supervise all live fire on the range. Additionally, the instruction offered must be done by a currently certified NRA certified Rifle Instructor. These must be two separate individuals.

**Ratio:** One NRA Range Safety Officer must be present for each group consisting of a maximum of eight shooters. And one NRA certified Rifle Instructor per 8 shooters during live fire.

**Course:** Shoot one or two 5-shot targets per relay, from a position appropriate to the skill level of the participants.

### Sample Range commands

- “Eye and ear protection on”
- “Shooters to the ready line.”
- “Shooters to the firing line”
- “Is the line ready?”
- “Load.”
- “Ready on the firing line.”
- “Commence firing.”
- “Cease fire.”
- “Remove magazines”

## BEFORE YOUTH ARRIVE AT THE PROGRAM AREA

All Rifles, ammunition, and targets are provisioned in sufficient quantity to run the program for all shooters without interruption during non-program times by maintenance and support personnel.

### ON THE RANGE

- Eye and ear protection should be cleaned between each shooter.
- Range staff will assist the RSO and Instructor by preparing rifles, ammunition to the preparation table, and setting up shooting positions on range.
- General staging areas for shooters and those waiting their turn are clearly marked and safe gun handling rules posted.

**People in program areas adjacent to the firing line must wear ear protection if measured sound levels are 85 dB (decibel) or above.**

## WHEN YOUTH ARE PRESENT IN THE PROGRAM AREA

Welcome youth to the area and begin the gun handling safety briefing. Range Safety Officer(RSO) is responsible for all activities on the range.

## RANGE INSPECTION CHECKLIST

Inspected by \_\_\_\_\_ Date \_\_\_\_\_

√ = Yes

- Controlled access/fencing/gates closed
- Flags or signs displayed
- Range limits identified
- Backstop/impact area inspected
- Ready line/area marked
- Spectator area designated
- Supplies available
- First-aid kit filled/accessible
- Range rules posted
- Bulletin board available
- Rifle racks available
- Empty trash receptacles available
- Lockable storage
- Throwers available and loaded
- Eye and ear protection available
- Hand washing Station Available

## Range Safety Briefing – Rifle

- No LIVE Ammunition in the classroom!
- To provide beginning shooters with Knowledge, Skill and Attitude (KSA) necessary to shoot a Rifle safely under supervision of a certified instructor.
- 3 Rules of Gun Safety
  - Always keep your gun pointed in a safe direction
  - Always keep your finger off the trigger until ready to shoot
  - Always keep your gun unloaded until ready to us.
- Parts of a Rifle
- Demonstrate Rifle operation
  - Loading dummy rounds
  - Cocking
  - Dry Fire
  - Unloading
- Shooting Fundamentals
  - Dominant Eye
  - Position
  - Shooting Fundamentals
    1. Aiming
    2. Hold Control
    3. Breath Control
    4. Trigger Control
    5. Follow-through
- Range Layout
  - Ready Area
  - Firing Line
  - Target Area
  - Back Stop
- Other Safety Rules
  - Know your target and what is beyond
  - Eye and Ear Protection
  - No alcohol or drugs
  - Proper hygiene
  - Clean up after shooting
- Range Commands
  - “Eye and ear protection on”
  - “Shooters to the ready line.”
  - “Shooters to the firing line”
  - “Is the line ready?”
  - “Load.”
  - ”Ready on the firing line.”
  - “Commence firing.”
  - “Cease fire.”
  - “Remove magazines”

Before running a program check out the Range and Target Activities Webpage for updates to this program guide and find other resources.

For questions or additional information, contact the National Service Center at [outdoorprograms@scouting.org](mailto:outdoorprograms@scouting.org)



# APPENDIX 15 - INSTRUCTIONAL SHOTGUN EXPERIENCE

## For Scouts BSA Members, Venturers And Sea Scouts

### INTRODUCTION

This guide is intended to provide units, districts and councils with an overview of the requirements for running the shooting program ensuring all Scouting America Policies are followed under NRA Certified Shotgun Instructor and Range Safety Officer (RSO). In this publication, you will find youth requirements, training requirements for adults who are facilitating a Shotgun instruction program for youth. The program offers a fun and safe introduction to safe handling of a shotgun.

### PROGRAM GUIDELINES

#### Youth Requirements

Registered Scouts BSA members, Venturers or Sea Scouts and youth who are age appropriate participating in a Shotgun instructional curriculum designed to develop and improve shooting skills.



### STANDARD OPERATING PROCEDURES

The standard operating procedures (SOPs) of the range should also be reviewed by NRA Range Safety Officer before delivering this program. All firearms must be approved for use by the NRA Range Safety Officer.

### THE RANGE

An approved range can include:

- Scouting America Range at an accredited camp
- Commercial range.

### ADULT SUPERVISION AND TRAINING REQUIREMENTS

1. Scouting America Youth Protection policies for two deep leadership must be maintained at all times.
2. Instructors must have current certification from the NRA as a Instructor
3. RSO must have current certification from the NRA as a Range Safety Officer (RSO).

### APPLICABLE LAWS

Scouting America safety policies generally run parallel to or go beyond legal mandates. However, it is the camp or activity supervisor's responsibility to confirm and ensure compliance with all applicable federal, state, and local regulations or statutes related to youth handling and using a firearm.



### INSTRUCTIONAL SHOOTING SPORTS PROGRAM

**Purpose:** To develop in youth the Knowledge, Skill and Attitude (KSA) of safe handling of a Shotgun by participation in a formal Shotgun shooting curriculum.

**Examples:** Examples of ongoing programs are the Scouts BSA Shotgun Shooting Merit Badge, and Venturing Ranger Award. Shooting programs could be held at a Scouting America range at an accredited camp or a commercial range.

**Youth:** Scouts BSA members, Venturers, Sea Scouts

**Shotgun:** Youth- and adult-size 12 or 20 gauge gas-operated semi-automatic shotguns.



**Ammunition:** Correct ammunition for the shotgun being fired. Light loads of shot size #7½ or smaller is recommended. **Reloaded ammunition is not approved for Scouting America programs.**

**Range:** A Scouting America range at an accredited camp or a commercial range.

**Training for Scouts BSA members:** NRA FIRST Steps Shotgun Orientation (3 hrs.) or NRA Basic Shotgun Shooting Course (8 hrs.), taught by a certified NRA Shotgun Instructor. The Scouts BSA Shotgun Shooting Merit Badge

**Training for Sea Scouts and Venturers:** Shotgun Safety Briefing in this document.

**Training References:** Scouts BSA Shotgun Merit Badge Pamphlet; Download Ranger Award Requirements

**Safety:** ANSI Z87.1-2010 certified eye protection and hearing protection is required.

**Range supervision:** A certified NRA Range Safety Officer is to directly supervise all live fire on the range. Additionally, the instruction offered must be done by a currently certified NRA certified Shotgun Instructor. These must be two separate individuals.

**Ratio:** One NRA Range Safety Officer must be present for each group consisting of a maximum of six shooters. One NRA certified Shotgun Instructor for each active shooter is required when loading and firing a shotgun.

**Course:** Begin with slow, single, straight away and incoming targets. An example would be a single trap with one shell loaded at a time. As skill and confidence improve, provide more challenging target .

- Command: “Eye and ear protection on.”
- Command: “Move forward to your shooting position.”
- Command: “Practice mounting and following a target with the gun.”
- Command: “Load and prepare to fire.”
- Command: “Is the trapper ready?”
- Command: “Call “Pull” when shooter is ready.”

Continue until shooter has completed the course of fire.

- Command: “Cease fire.”
- Command: “Range is clear.”
- Command: “You may exit the shooting area.”
- Command: “Remove eye and ear protection.”

## **BEFORE YOUTH ARRIVE AT THE PROGRAM AREA**

All shotguns, ammunition, and targets are provisioned during non-program times by maintenance and support personnel in sufficient quantity to run the program for all shooters without interruption.

## **ON THE RANGE**

- Eye and ear protection should be cleaned between each shooter.
- Range staff will assist the RSO and Instructor by loading the trap, preparing shotguns, ammunition to the preparation table, and setting up shooting positions on range.
- General staging areas for shooters and those waiting their turn are clearly marked and safe gun handling rules posted.

**People in program areas adjacent to the firing line must wear ear protection if measured sound levels are 85 dba or above.**

## **WHEN YOUTH ARE PRESENT IN THE PROGRAM AREA**

Welcome youth to the area and begin the gun handling safety briefing. Range Safety Officer (RSO) is responsible for all activities on the range.

## RANGE INSPECTION CHECKLIST

Inspected by \_\_\_\_\_ Date \_\_\_\_\_

√ = Yes

- \_\_\_ Controlled access/fencing/gates closed
- \_\_\_ Flags or signs displayed
- \_\_\_ Range limits identified
- \_\_\_ Backstop/impact area inspected
- \_\_\_ Ready line/area marked
- \_\_\_ Spectator area designated
- \_\_\_ Supplies available
- \_\_\_ First-aid kit filled/accessible
- \_\_\_ Range rules posted
- \_\_\_ Bulletin board available
- \_\_\_ Shotgun racks available
- \_\_\_ Empty trash receptacles available
- \_\_\_ Lockable storage
- \_\_\_ Throwers available and loaded
- \_\_\_ Eye and ear protection available
- \_\_\_ Hand washing Station Available

## Range Safety Briefing – Shotgun

- No Ammunition in the classroom!
- To provide shooters with Knowledge, Skill and Attitude (KSA) necessary to shoot a shotgun safely under supervision of a certified instructor.
- 3 Rules of Gun Safety
  - Always keep your gun pointed in a safe direction
  - Always keep your finger off the trigger until ready to shoot
  - Always keep your gun unloaded until ready to us.
- Parts of a shotgun
- Demonstrate shotgun operation
  - Loading dummy rounds
  - Cocking
  - Dry Fire
  - Unloading
- Shooting Fundamentals
  - Determine Eye Dominance
  - Stance
  - Hold Point
  - Mount
  - See the target
  - Swing
  - Pull the trigger
  - Follow through
  - The most important - Focus on the target
- Range Layout
  - Ready Area
  - Firing Line
  - Target Area
  - Back Stop
- Other Safety Rules
  - Know your target and what is beyond
  - Eye and Ear Protection
  - No alcohol or drugs
  - Proper hygiene
  - Clean up after shooting
- Range Commands
  - Command: “Eye and ear protection on.”
  - Command: “Move forward to your shooting position.”
  - Command: “Practice mounting and following a target with the gun.”
  - Command: “Load and prepare to fire when it is your turn. Begin shooting from the left.”
  - Command: “Is the trapper ready?”
  - Command: “Call “Pull” when shooter is ready.”

Continue until shooter has completed the course of fire.

- Command: “Cease fire.”
- Command: “Range is clear.”
- Command: “You may exit the shooting area.”
- Command: “Remove eye and ear protection.”

Before running a program check out the Shooting Sports Webpage for updates to this program guide and find other resources.

For questions or additional information, contact the National Service Center at [outdoorprogram@scouting.org](mailto:outdoorprogram@scouting.org).



# APPENDIX 16 - OPEN SHOTGUN EXPERIENCE

## For Scouts BSA Members, Venturers And Sea Scouts

### INTRODUCTION

This guide is intended to provide units, districts and councils with an overview of the requirements for running the shooting program ensuring all Scouting America Policies are followed under NRA Certified Shotgun Instructor and Range Safety Officer (RSO). In this publication, you will find youth requirements, training requirements for adults who are providing the program for camp and weekend program venues. The program offers a fun and safe introduction to safe handling of a shotgun.

### PROGRAM GUIDELINES

#### Youth Requirements

Registered Scouts BSA members, Venturers or Sea Scouts, and youth who are age-appropriate participating in a Council, District or Unit organized Shotgun Shooting activity conducted as part of a recruiting event.



### STANDARD OPERATING PROCEDURES

The standard operating procedures (SOPs) of the range should also be reviewed by NRA Range Safety Officer before delivering this program. All firearms must be approved for use by the NRA Range Safety Officer.

### THE RANGE

An approved range can include:

- Scouting America Range at an accredited camp
- Commercial range.

### ADULT SUPERVISION AND TRAINING REQUIREMENTS

1. Scouting America Youth Protection policies for two deep leadership must be maintained at all times.
2. Instructors must have current certification from the NRA as a Instructor
3. RSO must have current certification from the NRA as a Range Safety Officer (RSO).

### APPLICABLE LAWS

Scouting America safety policies generally run parallel to or go beyond legal mandates. However, it is the camp or activity supervisor's responsibility to confirm and ensure compliance with all applicable federal, state, and local regulations or statutes related to youth handling and using a firearm.





## SHOTGUN OPEN SHOOTING EXPERIENCE

**Purpose:** To provide shooters with Knowledge, Skill and Attitude (KSA) necessary to shoot a shotgun safely under supervision of a certified instructor.

**Examples:** Unit, District, or Council organized program which could include; a day-at-the-range event (fun shoot), recruiting new members, Winchester/NRA Marksmanship Qualification Program, camporee, camp weekend shoot, or Order of the Arrow event are examples.

**Youth:** Scouts BSA members, Venturers, Sea Scouts

**Shotgun:** Youth & adult-size 12 or 20 gauge shotguns.

**Ammunition:** Correct ammunition for the shotgun being fired. Light loads of shot size #7 or smaller is recommended. **Reloaded ammunition is not approved for Scouting America programs.**

**Training:** The Scouting America Safety Shotgun Briefing presented by an NRA Range Safety Officer. The Range Safety Rules are posted and reviewed during the briefing.

**Safety:** ANSI Z87.1-2010 certified eye protection and hearing protection is required.

**Range supervision:** An NRA Range Safety Officer is to directly supervise all live fire on the range. Additionally, the instruction must be done by a currently certified NRA Shotgun Instructor. These must be two separate individuals.

**Ratio:** One NRA Range Safety Officer must be present for each group consisting of a maximum of six shooters. One NRA certified Shotgun Instructor is required for each active shooter. At the discretion of the instructor, loading may be completed by the student or the instructor.

**There is not a policy in the Scouting America that requires the NRA Instructor to load the firearm.**

Below are examples of range commands assuming 1 inexperienced shooter with 1 instructor, using a single trap with a single presentation of target. The actual commands to use should be based on the course of fire, the circumstances and the number of shooting positions.

## Range Commands

- Command: “Eye and ear protection on.”
- Command: “Move forward to your shooting position.”
- Command: “Practice mounting and following a target with the gun.”
- Command: “Load and prepare to fire.”
- Command: “Is the trapper ready?”
- Command: “Call “Pull” when shooter is ready.”

Continue until shooter has completed the course of fire.

- Command: “Cease fire.”
- Command: “Range is clear.”
- Command: “You may exit the shooting area.”
- Command: “Remove eye and ear protection.”

## BEFORE THE YOUTH ARE ON THE RANGE

All shotguns, ammunition, and targets are provisioned during non-program times by maintenance and support personnel in sufficient quantity to run the program for all shooters without interruption.

## ON THE RANGE

- Eye and ear protection should be cleaned between each shooter.
- Range staff will assist the RSO and Instructor by loading the trap, preparing shotguns, ammunition to the preparation table, and setting up shooting positions on range.
- General staging areas for shooters and those waiting their turn are clearly marked and safe gun handling rules posted.

**People in program areas adjacent to the firing line must wear ear protection if measured sound levels are 85 dba or above.**

## WHEN YOUTH ARE PRESENT IN THE PROGRAM AREA

Welcome youth to the area and begin the gun handling safety briefing. Range Safety Officer(RSO) is responsible for all activities on the range.

## RANGE INSPECTION CHECKLIST

Inspected by \_\_\_\_\_ Date \_\_\_\_\_

√ = Yes

\_\_\_ Controlled access/fencing/gates closed

\_\_\_ Flags or signs displayed

\_\_\_ Range limits identified

\_\_\_ Backstop/impact area inspected

\_\_\_ Ready line/area marked

\_\_\_ Spectator area designated

\_\_\_ Supplies available

\_\_\_ First-aid kit filled/accessible

\_\_\_ Range rules posted

\_\_\_ Bulletin board available

\_\_\_ Shotgun racks available

\_\_\_ Empty trash receptacles available

\_\_\_ Lockable storage

\_\_\_ Throwers available and loaded

\_\_\_ Eye and ear protection available

\_\_\_ Hand washing Station Available

## Range Safety Briefing – Shotgun

- No Ammunition in the classroom!
- To provide shooters with Knowledge, Skill and Attitude (KSA) necessary to shoot a shotgun safely under supervision of a certified instructor.
- 3 Rules of Gun Safety
  - Always keep your gun pointed in a safe direction
  - Always keep your finger off the trigger until ready to shoot
  - Always keep your gun unloaded until ready to us.
- Parts of a shotgun
- Demonstrate shotgun operation
  - Loading dummy rounds
  - Cocking
  - Dry Fire
  - Unloading
- Shooting Fundamentals
  - Determine Eye Dominance
  - Stance
  - Hold Point
  - Mount
  - See the target
  - Swing
  - Pull the trigger
  - Follow through
  - The most important - Focus on the target
- Range Layout
  - Ready Area
  - Firing Line
  - Target Area
  - Back Stop
- Other Safety Rules
  - Know your target and what is beyond
  - Eye and Ear Protection
  - No alcohol or drugs
  - Proper hygiene
  - Clean up after shooting

- Range Commands
  - Command: “Eye and ear protection on.”
  - Command: “Move forward to your shooting position.”
  - Command: “Practice mounting and following a target with the gun.”
  - Command: “Load and prepare to fire.”
  - Command: “Is the trapper ready?”
  - Command: “Call “Pull” when shooter is ready.”

Continue until shooter has completed the course of fire.

- Command: “Cease fire.”
- Command: “Range is clear.”
- Command: “You may exit the shooting area.”
- Command: “Remove eye and ear protection.”

Before running a program check out the Shooting Sports Webpage for updates to this program guide and find other resources.

For questions or additional information, contact the National Service Center at [outdoorprograms@scouting.org](mailto:outdoorprograms@scouting.org)



## APPENDIX 17 - SPORTING ARROWS

### Archery Range Considerations for Laporte's Bowtrap System

The following parameters of the program and site requirements must be followed as outlined in order to execute the program correctly. At this time, the only equipment to be used with the Laporte Bowtrap System is a bow with a maximum of a 26-pound pull and the Laporte proprietary safety arrows, or "Fluflu Arrows."

**Purpose & Scope:** This Design Guideline will address the basic parameters of the range or area that will be used for sporting arrows. "Sporting Arrows" was introduced to the Scouting community at the 2017 National Scout Jamboree. This is a program is only for Scouts BSA members, Venturers and Sea Scouts. This is a new archery game where Scouts fire at foam disk that are launched in the air or rolled along the ground by a proprietary "Bowtrap" manufactured by Laporte <https://www.laporte.biz/en-us/archery/>.



This Design Guideline is based on the use of a maximum of a 26-pound bow with Laporte's proprietary safety arrows, or "Flu-flu Arrows", and winds of 30 miles per hour or less. Laporte's proprietary safety arrows, or "Flu-flu Arrows", are design to be used with these foam targets and have a maximum range of 190 feet (see Drawing No. 1).

**Fall Areas:** Because archers will be shooting at various angles, a 180 degree safety area, referred to as a fall area shall be fenced or marked in such a way to prevent people from accidentally walking into the sporting arrow range. The majority of the arrows will fall in the primary fall area, a 90 degree area centered in front of the shooters. This area should be clear of trees to ensure safety and help with the recovery of the arrows. It is permissible to have trees or other tall vegetation in the side fall areas, but they should be cleared if possible. The perimeter of this fall area shall be clearly marked. This could be permanent fence or a temporary fence/caution line. Permanent and temporary fences should be clearly marked and labeled to prevent people from accidentally walking on the range. Temporary fences should be installed in such a way that it will survive a weekend of activity and weather.

**Supervisory Personnel:** There should be a ratio of 1 Level I Archery instructor supervising up to 3 shooters on the range. Only 3 shooters allowed at one time on the range per Design Guideline 316 found at <https://www.scouting.org/outdoor-programs/properties/resources/design-guidelines/>. The Level I Archery instructor must be a minimum of 18 years old. This applies to year-round use of the sporting arrows program, both summer resident and year-round camping.

If a council is in need of locating a Level I Archery instructor, there is a USA Archery website which lists who they are and where they are in the country. At this site, you can also find where the training opportunities are offered to get this certification.

Go to: <http://www.teamusa.org/USA-Archery/Coaching/Find-an-Instructor-or-Coach>

**References:**

# APPENDIX 18 - CUB SCOUT RANGE AND TARGET ACTIVITIES ADVENTURE LESSON PLANS

## A Guide to the Cub Scout Range and Target Activities Adventures for Unit Leaders, Councils, Districts, and Range Masters

### PREFACE

Cub Scout range and target activities programs may be conducted only on a district or council level. Archery, BB gun shooting, and slingshot shooting are restricted to day camps, Cub Scout/Webelos Scout resident camps, council-managed family camping programs, or council activities where there are properly trained supervisors and where all standards for Scouting America range and target activities are enforced. All shooting ranges in the Cub Scout program must be supervised by a qualified Rangemaster who is at least 18 years of age and meets the minimum requirements. See specific qualifications and training requirements for Cub Scout Range and Target Activities Rangemasters in the *Scouting America Range and Target Activities Manual*, No. 430-938.

### USING THIS GUIDE

- Archery, BB gun shooting, and slingshot shooting are not approved unit activities.
- The use of pellet air rifles is restricted to Webelos Scouts and Arrow of Light Scouts in a Boy Scouts of America resident camp setting only.
- Kindergarten–age youth in the Lion program may participate in Cub Scout archery or slingshot activities.
- **Airsoft guns are not approved for use in the Cub Scout range and target activities program.**
- **All local, state, and federal laws for BB guns, archery, and slingshot shooting must be followed.**

This *Cub Scout Range and Target Activities Guide* is intended to assist leaders in helping their Cub Scouts earn the shooting sports awards. It is not a substitute for authorized Rangemaster training or for the safety procedures called out in the *Scouting America Range & Target Activities Manual*, No. 430-938, which is the reference for any range and target activities in Scouting America.

All volunteers participating in official Scouting activities should become familiar with the *Guide to Safe Scouting*. The Guide to Safe Scouting may be found online at [www.scouting.org/scoutsorce/HealthandSafety/GSS](http://www.scouting.org/scoutsorce/HealthandSafety/GSS).



## SECTION I: INTRODUCTION

The goal of this guide is to support range and target activities directors, Rangemasters, and on-range adult volunteers as they assist Cub Scouts in meeting the requirements of the Cub Scout range and target activities adventures according to Scouting America policy and practice. This resources supports — but does not replace — the *Scouting America Range and Target Activities Manual*.

The Cub Scouting range and target activities disciplines of archery, BB gun shooting, and slingshot shooting are restricted to day camps, Cub Scout/Webelos Scout resident camps, council-managed family camping programs, or council activities held on or off Scouting America property where there are current and properly trained Scouting America Rangemasters and where all standards for Scouting America Range and Target Activities are enforced.

### **Purpose of the Cub Scout Range and Target Activities Adventures**

As decades of Cub Scouting have shown, most youth love to shoot!

Beyond capturing that enthusiasm, the Scouting America created the Cub Scout range and target activities adventures program to encourage in Cub Scouts the development of safe shooting practices and proficiency. As Cub Scouts participate in range and target activities and work toward an award, they not only build confidence in their abilities, but also develop self-reliance, sportsmanship, and conservation awareness — all elements of good character valued in Scouting.

Through experiential learning guided by a knowledgeable adult, Cub Scouts will learn the safe and responsible use of BB guns, slingshots, and archery equipment. The goal is for the Cub Scout to have fun in a safe environment, not to become an expert marksman, Rangemaster, or hunter.

### **Lions, Tigers: Range and Target Activities**

Lions and their adult partners may participate in archery or slingshot range and target activities. Tigers and their adult partners may participate in all Cub Scouting range and target activities. The adult partners must be included in all shooting activities. Each Lion/Tiger must be paired with their adult partner before being allowed to shoot. In most cases, Lions/Tigers and their adult partners will participate in range and target activities at a day camp.

Keep in mind that youth of this age have very short attention spans (20 to 30 minutes, maximum) and tire easily. They probably have little experience working as a group and may require more time to understand how the range operates. Lions/Tigers have a wide range of ability and experience levels, so be ready for anything!

### **Structure of the Cub Scout Range and Target Activities Adventures**

Cub Scout range and target activities adventures may be earned for any of the three following disciplines:

- Archery
- BB guns (available only for Tiger through Arrow of Light ranks.)
- Slingshots

A Cub Scout may choose to participate in only one of the disciplines or may choose to participate in all three disciplines. The requirements for each of the disciplines are structured similarly.

## SECTION 2: CUB SCOUT RANGE AND TARGET ADVENTURE LESSON PLANS

(for Council/District sponsored events only)

### CUB SCOUT ARCHERY ADVENTURE LESSON PLAN

#### PURPOSE

This lesson plan is provided for rangemasters to teach the Slingshot Adventure at a council-sponsored long-term camp, short-term camp, day camp or one day activity. The Slingshot Adventures are available for each Cub Scout rank.

Units are not authorized to hold range and target activities at the den or pack level. The information in this lesson plan is not meant to replace any information in the *National Range and Target Manual* or the *Guide to Safe Scouting*.

This lesson plan was developed as a guide for a 5-session day camp or twilight camp experience with (5) 45-minute sessions. The rangemaster may adjust this plan to meet the event's program schedule if the requirements are met as written. Suggestions for other events and mixed age dens are at the end of this lesson plan.

As with all Scouting activities, Lion Scouts and Tiger Scouts must have their adult partner with them while at the archery range.

*NOTE: When the word 'demonstrate' is used in a requirement, a simple demonstration made by the Cub Scout showing their understanding will serve as meeting that requirement. When appropriate, some demonstrations/discussions can be held away from the firing line. Each Cub Scout should do their best based on their physical abilities.*

#### REQUIREMENTS FOR ALL RANKS

1. Identify and wear appropriate safety gear. (Lions and Tigers: with the help of their adult partner.)
2. Demonstrate the archery range safety rules and whistle commands. (Lions and Tigers will recite rules and commands with the help of their adult partner)
3. Demonstrate proper range commands. (Lions and Tigers: with the help of their adult partner. Additionally, Webelos and Arrow of Light will "Demonstrate proper range commands and explain them to an adult or to another Scout")
4. Identify the main parts of your shooting equipment and how to properly use them. (Lions and Tigers with the help of their adult partner)
5. Demonstrate proper stance and shooting techniques. (Lions and Tigers: with the help of their adult partner)
6. Shooting Requirements:

<b>Lion</b>	Shoot 2 arrows at target. Repeat and try to improve your score. A minimum of 4 arrows are shot.
<b>Tiger</b>	Shoot 3 arrows at target. Repeat and try to improve your score. A minimum of 6 arrows are shot.
<b>Wolf</b>	Shoot 5 arrows at target. Repeat two times and try to improve your score. A minimum of 10 arrows are shot.
<b>Bear</b>	Shoot 5 arrows at a target. Repeat twice and do your best to improve your score each time. Shoot at least 15 arrows.
<b>Webelos</b>	Shoot 5 arrows at target. Repeat three times and try to improve your score. A minimum of 20 arrows are shot.
<b>Arrow of Light</b>	Shoot 5 arrows at target. Repeat 4 times and try to improve your score. A minimum of 25 arrows are shot.

Rangemaster Note: The arrows do not have to be shot in one session but may be spread across multiple sessions.

7. Demonstrate how to safely retrieve your arrows.
8. Discuss how to put away and properly store your archery shooting equipment after use.



## SESSION 1 [45 MINUTES]

### PREPARATION & MATERIALS NEEDED

- Safety rules posters
- Appropriate safety equipment as specified in the *National Range and Target Manual*
- Appropriate archery equipment as specified in the *National Range and Target Manual*
- Archery targets
- Whistle

### TOPIC: GEAR & SAFETY

It is important that Cub Scouts learn the importance of safety rules while participating in range and target activities and the need for appropriate safety gear.

- Participants must wear age-appropriate arm guards and finger tabs when at the firing line.

To prepare the Cub Scouts for being on the shooting line, please do the following:

- Demonstrate how to properly wear the safety equipment. (Requirement 1)
- Explain the range safety rules and whistle commands. It is important that the Rangemaster gets feedback from the group to ensure complete understanding of the safety rules and range commands. Lions and Tigers will have assistance from their adult partner. (Requirement 2)
- Demonstrate proper range commands. Note: Webelos and Arrow Light have an added requirement to explain range commands to an adult or another Scout. (Requirement 3)

Move the group to the shooting line to do the following:

- Show and explain the main parts of the shooting equipment and how to properly use. (Requirement 4)
- Demonstrate proper stance and shooting techniques. (Requirement 5)
- Allow Cub Scouts to shoot for the remaining time in the session. (Requirement 7)

Requirements 1-5 should be complete after this session.

*Note: This session is critical because it establishes the basis for range safety, understanding range commands and understanding whistle commands, but it is equally important that the Cub Scouts get to shoot before leaving the session.*

## SESSION 2 [45 MINUTES]

### PREPARATION & MATERIALS NEEDED

- Safety rules posters
- Appropriate safety equipment as specified in the *National Range and Target Manual*
- Appropriate archery equipment as specified in the *National Range and Target Manual*
- Archery targets
- Whistle

### TOPIC: RANGE ACTIVITY

Review the range safety rules, range commands and whistle commands. To engage with the Cub Scouts, ask them to explain the rules and range commands in their own words (rather than telling them).

- Cub Scouts shoot and attempt to complete requirement 6.
- Explain and demonstrate how to properly retrieve arrows. (Requirement 7)

Requirements 6-7 should be complete after this session.

## SESSION 3 [45 MINUTES]

### PREPARATION & MATERIALS NEEDED

- Safety rules posters
- Appropriate safety equipment as specified in the *National Range and Target Manual*
- Appropriate archery equipment as specified in the *National Range and Target Manual*
- Archery targets
- Whistle
- Materials for designated archery game

### TOPIC: RANGE ACTIVITY

Review the range safety rules, range commands and whistle commands. To engage with the Cub Scouts, ask them to explain the rules and range commands in their own words (rather than telling them).

- Cub Scouts shoot and attempt to complete requirement 6.
- If requirement 6 was complete during the previous session, those Cub Scouts may play an approved archery game (sample games listed at the end of this document).
- Leave enough time in today's session to discuss how to put away and properly store archery shooting equipment after use. If feasible, Cub Scouts may assist with storing the archery equipment. (Requirement 8)

Requirement 8 should be complete after this session.

## SESSION 4 (45 MINUTES)

### PREPARATION & MATERIALS NEEDED

- Safety rules posters
- Appropriate safety equipment as specified in the *National Range and Target Manual*
- Appropriate archery equipment as specified in the *National Range and Target Manual*
- Archery targets
- Whistle
- Materials for designated archery game

### TOPIC: RANGE ACTIVITY

Review the range safety rules, range commands and whistle commands. To engage with the Cub Scouts, ask them to explain the rules and range commands in their own words (rather than telling them).

- Cub Scouts shoot and attempt to complete requirement 6.
- If requirement 6 was complete during the previous session, those Cub Scouts may play an approved archery game (sample games listed at the end of this document).

## SESSION 5 (45 MINUTES)

### PREPARATION & MATERIALS NEEDED

- Safety rules posters
- Appropriate safety equipment as specified in the *National Range and Target Manual*
- Appropriate archery equipment as specified in the *National Range and Target Manual*
- Archery targets
- Whistle
- Materials for designated archery game

### TOPIC: RANGE ACTIVITY

Review the range safety rules, range commands and whistle commands. To engage with the Cub Scouts, ask them to explain the rules and range commands in their own words (rather than telling them).

- Cub Scouts shoot and attempt to complete requirement 6.
- If requirement 6 was complete during the previous session, those Cub Scouts may play an approved archery game (sample games listed at the end of this document).

## RANGE REQUIREMENTS

### ARCHERY RANGE SET-UP

Archery activities must utilize an approved archery range.

1. Select the orientation of the range
  - a. Avoid shooting into the sun by facing North
  - b. The ground should be flat and free of obstacles
  - c. Look for a natural backstop such as a berm to stop arrows. If there is no berm, provide at least 150 yards of open area behind the targets.
  - d. The safety zone on the side should be 30-50 feet.
2. Place range and safety lines
  - a. Rope, eco-friendly spray paint or chalk are ways to lay down the range lines outdoors. Follow the guidelines illustrated in the *National Range and Target Manual*.
  - b. Shooting Line – The shooting line should be placed close enough to the target line to ensure archers have an opportunity to hit the target. This line can be moved back to greater distances as archers become more advanced. The shooting line is placed 15-30 feet from the target line.
  - c. Waiting Line – Shooters stand behind the waiting line before and after shooting their arrows. It is meant to act as a safety area between the class and the shooting line. The waiting line is placed 15 feet behind the shooting line.  
*OPTIONAL: Controlled Access/Spectator Line – Anyone who wants to watch participants shoot can gather behind this line. This line needs to be placed far enough behind the waiting line to prevent distraction from the spectators (at minimum 15 feet)*
3. Set-up targets
  - a. Place targets in front of the natural berm. If a natural berm is not available, place targets in a wide-open space with a minimum safety zone of 150 feet behind the targets.
  - b. Evenly space targets in front of the berm. It is best to place the targets five feet, or two arrow lengths, from target-center to target-center. Evenly spaced targets allow for multiple people to shoot at the same target safely.
4. Place the equipment
  - a. Bows – The bow rack should be placed between the waiting line and the shooting line. Place all bows in the bow rack when not in use.
  - b. Ground Quivers – Ground quivers are evenly spaced apart on the shooting line. Two quivers per target are suggested.

c. Arrows – Place arrows in a secure location near the bow rack. Once the instructor/rangemaster is comfortable with an archer's

skill level, arrows may be placed in each individual archer's ground quiver.

## OUTDOOR RANGE LAYOUT: WIDE OPEN SPACE

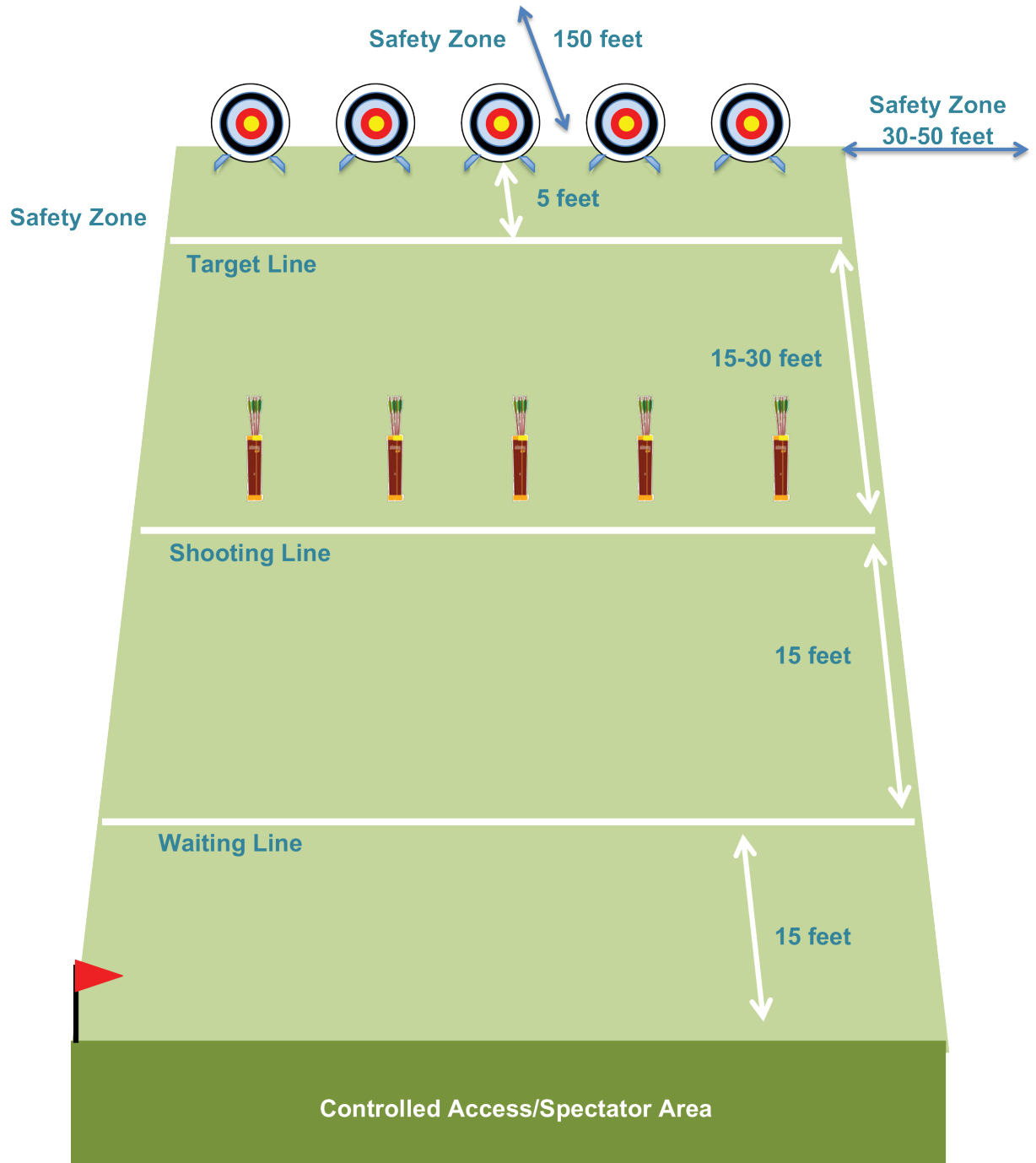



## SUGGESTIONS

Based on the format of your event, there might not be enough time in the program schedule to utilize 5 sessions to complete the Archery Adventure. You may also have dens with mixed ages and levels of knowledge and/or ability. There are times when a Cub Scout can attend only a few days of a day camp, so adjustments will need to be made.

Take the time to read the requirements, evaluate the number and the length of the sessions the event will have so you can determine what should be presented in the time allotted.

It is possible the adventure could be completed within 3 sessions or less depending on your event's program design:

- Length of each session
- Age of participants
- Experience level of the participants
- Number of participants in each den

### MIXED-AGED DENS

When dealing with dens of mixed ages, consider moving the more experienced participants (the older Scouts who have attended a range activity previously) to the shooting line after the safety briefing to begin their course of fire. The less experienced Scouts can then spend time learning range commands, how to properly use safety equipment and archery equipment, and how to properly retrieve arrows from a target. This same method may be applied with larger groups. You may be required to recruit additional trained staff to maintain range supervision ratios.

### PARTIAL COMPLETION OF THE REQUIREMENTS

Depending on the type of event (i.e., one-day event) it is possible the adventure requirements may not be completed in their entirety. If this is the case, each participant should be given a list of the requirements completed so that they can bring it to the next council-sponsored event they attend.

# CUB SCOUT BB GUN ADVENTURE LESSON PLAN

## PURPOSE

This lesson plan is provided for rangemasters to teach the BB Gun Adventures at a council-sponsored long-term camp, short-term camp, day camp or one day activity. The BB Gun Adventures are available for each Cub Scout rank, except for Lions.

Units are not authorized to hold range and target activities at the den or pack level. The information in this lesson plan is not meant to replace any information in the *National Range and Target Manual* or the *Guide to Safe Scouting*.

This lesson plan was developed as a guide for a 5-session day camp or twilight camp experience with (5) 45-minute sessions. The rangemaster may adjust this plan to meet the event's program schedule if the requirements are met as written.

The BB Gun Adventure is an ideal range activity for day camps lasting less than 5 days or even one day events. Suggestions for other events and mixed age dens are at the end of this lesson plan.

Tiger Scouts must have their adult partner with them while at the BB gun range.

*NOTE: When the word 'demonstrate' is used in a requirement, a simple demonstration made by the Cub Scout showing their understanding will serve as meeting that requirement. Where the word 'discover' is used in a requirement, explanation accompanied by visual aids will serve as meeting that requirement. When appropriate, some demonstrations/discussions can be held away from the firing line. Each Cub Scout should do their best based on their physical abilities.*

## REQUIREMENTS FOR ALL RANKS

1. Explain what you should do if you find a gun. Recite the 4 safety reminders (Tigers with the help of their adult partner).
2. Identify and wear the appropriate safety gear (Tigers with the help of their adult partner).
3. Demonstrate proper range commands (Tigers with the help of their adult partner, additionally Bear, Webelos and Arrow of Light Scouts are to demonstrate proper range commands and explain them to an adult or another scout).
4. Show how to use the safety mechanism. (Tigers with the help of their adult partner)

5. Demonstrate how to properly load, fire, and secure your BB gun (Tigers with the help of their adult partner).
6. Demonstrate one of the positions for shooting a BB gun (Tigers with the help of their adult partner, additionally Webelos and Arrow of Light are to demonstrate prone, bench and sitting positions for shooting a BB gun). Note: this is a demonstration requirement and not mandatory as a shooting requirement.
7. Shooting Requirements:

<b>Tiger</b>	Fire 5 BBs at the target. With the help of your Tiger adult partner, score your target. Repeat and do your best to improve your score. Fire at least 10 BBs.
<b>Wolf</b>	Fire 5 BBs at the target and score your target. Repeat twice and do your best to improve your score. Fire at least 15 BBs.
<b>Bear</b>	Fire 5 BBs at the target and score your target. Repeat twice and do your best to improve your score. Fire at least 15 BBs.
<b>Webelos</b>	Webelos Shoot 5 shots at a target. Repeat three times and do your best to improve your score each time. Shoot at least 20 BBs
<b>Arrow of Light</b>	Shoot 5 shots at a target. Repeat three times and do your best to improve your score each time. Shoot at least 20 BBs.

8. Discuss how to put away and properly store your BB gun and shooting equipment after use.

## SESSION I (45 MINUTES)

### PREPARATION & MATERIALS NEEDED

- Safety rules posters
- Appropriate safety equipment as specified in the *National Range and Target Manual*
- Appropriate BB gun equipment as specified in the *National Range and Target Manual*
- Approved targets

### TOPIC: GEAR & SAFETY

It is important that participants learn the importance of safety rules while participating in range and target activities and the need for appropriate safety gear.

- Participants and range staff must wear eye protection (safety glasses) when the BB gun range is used.

To prepare the participants for being on the shooting line, please do the following:

- Explain what you should do if you find a gun. Recite the 4 safety reminders.

- Demonstrate how to properly wear the safety equipment.
- Explain the range safety rules and range commands. It is important that the Rangemaster gets feedback from the group to ensure complete understanding of the safety rules and range commands. Tigers will have assistance from their adult partner. Note: Webelos and Arrow Light Scouts have the added requirement of explaining range commands to an adult or another Scout.

Move the group to the shooting line to do the following:

- Show how to use the safety mechanism.
- Demonstrate how to properly load, fire, and secure your BB gun.
- Demonstrate one of the positions for shooting a BB gun.
- Allow participants to shoot for the remaining time.

Requirements 1-6 should be complete after this session.

*Note: This session is important because it establishes the basis for range safety and understanding range commands, but it is equally important that the participants get to shoot before leaving the session.*

## SESSION 2 (45 MINUTES)

### PREPARATION & MATERIALS NEEDED

- Safety rules posters
- Appropriate safety equipment as specified in the *National Range and Target Manual*
- Appropriate BB gun equipment as specified in the *National Range and Target Manual*
- Approved targets

### TOPIC: RANGE ACTIVITY

Review the range safety rules and range commands. To engage the participants, ask them to explain the rules and range commands in their own words (rather than telling them).

- Participants shoot and attempt to complete requirement 7.
- Discuss how to put away and properly store your BB gun and shooting equipment after use. (Requirement 8)

Requirements 7-8 should be complete after this session.

## SESSION 3 (45 MINUTES)

### PREPARATION & MATERIALS NEEDED

- Safety rules posters
- Appropriate safety equipment as specified in the *National Range and Target Manual*
- Appropriate BB gun equipment as specified in the *National Range and Target Manual*
- Approved targets

### TOPIC: RANGE ACTIVITY

Review the range safety rules and range commands. To engage the Cub Scouts, ask them to explain the rules and range commands in their own words (rather than telling them).

- Participants continue to shoot. If requirement 7 was not completed during the previous session, those Cub Scouts may continue working on that requirement.
- If requirement 7 was completed during the previous session, participants may play an approved BB gun game (suggested games listed at the end of this lesson plan).

## SESSION 4 (45 MINUTES)

### PREPARATION & MATERIALS NEEDED

- Safety rules posters
- Appropriate safety equipment as specified in the *National Range and Target Manual*
- Appropriate BB gun equipment as specified in the *National Range and Target Manual*
- Approved targets

### TOPIC: RANGE ACTIVITY

Review the range safety rules and range commands. To engage the Cub Scouts, ask them to explain the rules and range commands in their own words (rather than telling them).

- Participants continue to shoot. If requirement 7 was not completed during the previous session, those Cub Scouts may continue working on that requirement.
- If requirement 7 was completed during the previous session, participants may play an approved BB gun game (suggested games listed at the end of this lesson plan).

## SESSION 5 (45 MINUTES)

### PREPARATION & MATERIALS NEEDED

- Safety rules posters
- Appropriate safety equipment as specified in the *National Range and Target Manual*
- Appropriate BB gun equipment as specified in the *National Range and Target Manual*
- Approved targets

### TOPIC: RANGE ACTIVITY

Review the range safety rules and range commands. To engage the Cub Scouts, ask them to explain the rules and range commands in their own words (rather than telling them).

- Participants continue to shoot. If requirement 7 was not completed during the previous session, those Cub Scouts may continue working on that requirement.
- If requirement 7 was completed during the previous session, participants may play an approved BB gun game (suggested games listed at the end of this lesson plan).

## RANGE REQUIREMENTS

### BB GUN RANGE SET-UP

BB gun program may utilize an approved BB gun range.

1. Select the orientation of the range
  - a. Avoid shooting into the sun by facing North
  - b. The ground should be flat and free of obstacles
  - c. Look for a natural backstop such as a berm to stop BB's, or a ballistic cloth or double layer, heavy duty tarp capable of stopping a bb as a trap. If there is no berm, provide a minimum of 195 yards of open area behind the targets.
  - d. The safety zone on the side should be 30-50 feet.
2. Place range and safety lines
  - a. Rope, eco-friendly spray paint or chalk are ways to lay down the range lines outdoors. Follow the guidelines illustrated in the *National Range and Target Manual*.
  - b. Shooting Line – The shooting line is 15 to 30 feet from the target line depending on the skill level of the participants.
  - c. Waiting Line – Shooters stand behind the waiting line before and after shooting their arrows. It is meant to act as a safety area between the class and the shooting line. The waiting line is placed 15 feet behind the shooting line.

*OPTIONAL: Controlled Access/Spectator Line – Anyone who wants to watch participants shoot can gather behind this line. This line needs to be placed far enough behind the waiting line to prevent distraction from the spectators (at minimum 15 feet)*

3. Set-up targets
  - a. Place targets in front of the natural berm. If a natural berm is not available, place targets in a wide-open space with a minimum safety zone of 150 feet behind the targets.
  - b. Evenly space targets in front of the berm. Space between targets is dependent on placement of shooting positions.
  - c. One method of hanging targets is to put up posts to hold “snow fence.” Attach the snow fence to the posts. Targets can be attached to the snow fence with clothes pins.
  - d. A temporary target holder can be made using yard signs with wire ground stands.
4. Place the equipment
  - a. Eye protection should be available in the waiting area. All participants on the range must wear eye protection.
  - b. BB guns – May be on the top of the bench if using the bench rest position, or on the mat used for the prone positions. If shooters are shooting from the standing position, there should be some type of stand where the BB guns may be placed when not in use.
  - c. Ammunition – Should be stored in a secure location between the shooting line and the ready line under the supervision of the rangemaster.

# OUTDOOR RANGE LAYOUT: WIDE OPEN SPACE

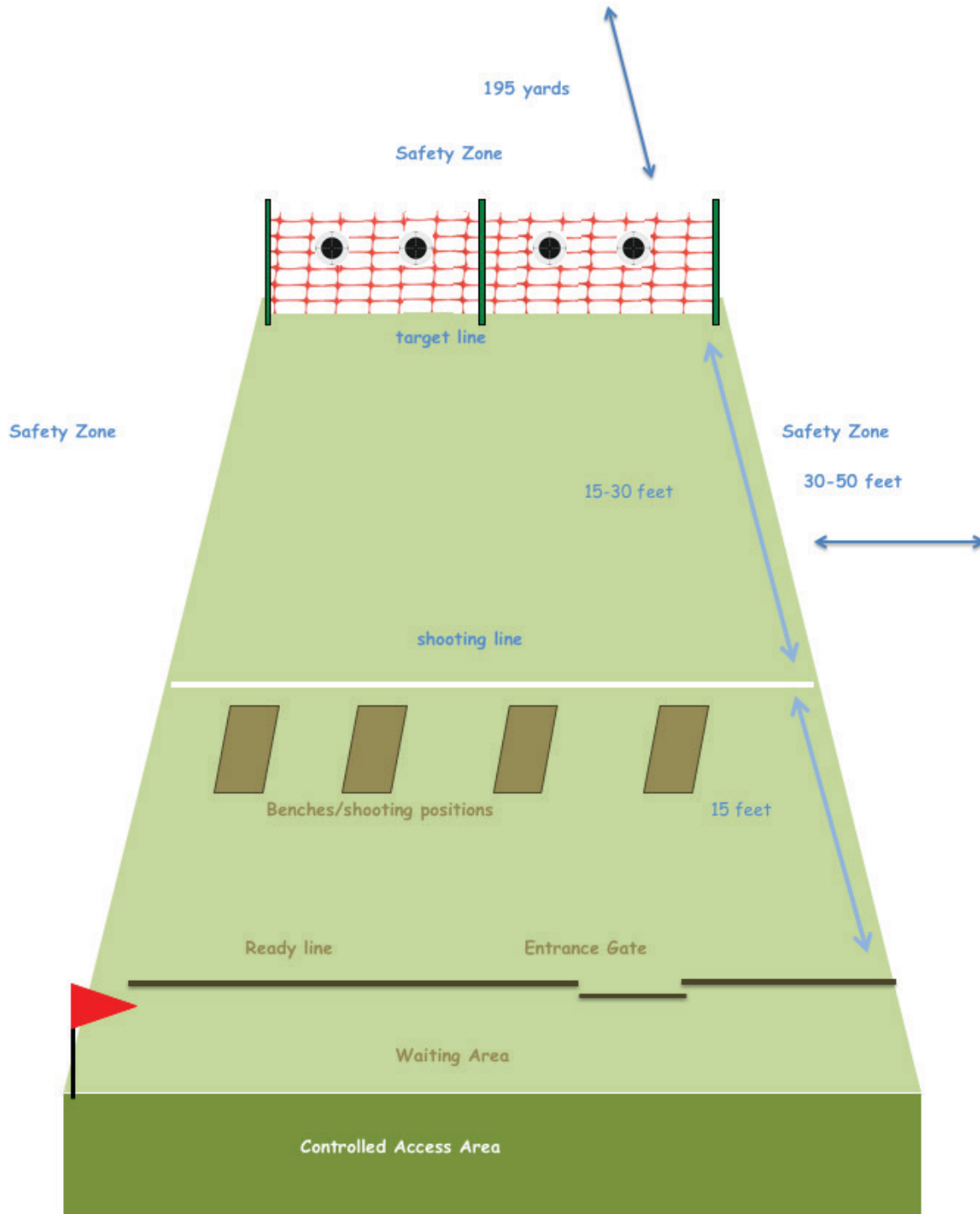

## SUGGESTIONS

Based on the format of your event, there might not be enough time in the program schedule to utilize 5 sessions to complete the BB Gun Adventure. You may also have dens with mixed ages and levels of knowledge and/or ability. There are times when a Cub Scout can attend only a few days of a day camp, so adjustments will need to be made.

Take the time to read the requirements, evaluate the number and the length of the sessions the event will have so you can determine what should be presented in the time allotted.

It is possible the adventure could be completed within 2 sessions or less depending on your event's program design:

- Length of each session
- Age of participants
- Experience level of the participants
- Number of participants in each den

### MIXED-AGED DENS

When dealing with dens of mixed ages, consider moving the more experienced participants (the older Scouts who have attended a range activity previously) to the shooting line after the safety briefing to begin their course of fire. The less experienced Scouts can then spend time learning range commands, how to use the safety equipment and how to use the BB gun equipment. This same method may be applied with larger groups. You may be required to recruit additional trained staff to maintain range supervision ratios.

### PARTIAL COMPLETION OF THE REQUIREMENTS

Depending on the type of event (i.e., one-day event) it is possible the adventure requirements may not be completed in their entirety. If this is the case, each participant should be given a list of the requirements completed so that they can bring it to the next council-sponsored event they attend.



# CUB SCOUT SLINGSHOT ADVENTURE

## LESSON PLAN

### PURPOSE

This lesson plan is provided for rangemasters to teach the Slingshot Adventures at a council-sponsored long-term camp, short-term camp, day camp or one day activity. The Slingshot Adventures are available for each Cub Scout rank.

Units are not authorized to hold range and target activities at the den or pack level. The information in this lesson plan is not meant to replace any information in the *National Range and Target Manual* or the *Guide to Safe Scouting*.

This lesson plan was developed as a guide for a 5-session day camp or twilight camp experience with (5) 45-minute sessions. The rangemaster may adjust this plan to meet the event's program schedule if the requirements are met as written.

The Slingshot Adventure is an ideal range activity for day camps lasting less than 5 days or even one day events. Suggestions for other events and mixed age dens are at the end of this lesson plan.

Lion Scouts and Tiger Scouts must have their adult partner with them while at the slingshot range.

*NOTE: When the word 'demonstrate' is used in a requirement, a simple demonstration made by the Cub Scout showing their understanding will serve as meeting that requirement. Where the word 'discover' is used in a requirement, explanation accompanied by visual aids will serve as meeting that requirement. When appropriate, some demonstrations/discussions can be held away from the firing line. Each Cub Scout should do their best based on their physical abilities.*

### REQUIREMENTS FOR ALL RANKS

1. Identify and wear appropriate safety gear. (Lions and Tigers: with the help of their adult partner.)
2. Recite the safety rules for using a slingshot. (Lions and Tigers: with the help of their adult partner)
3. Demonstrate proper range commands. (Lions and Tigers: with the help of their adult partner. Additionally, Webelos and Arrow of Light will "Demonstrate proper range commands and explain them to an adult or to another Scout")
4. Explore the parts of a slingshot and their proper usage. (Lions and Tigers: with the help of their adult partner)
5. Discover the types of ammunition that may be used and types that may not be used. (Lions and Tigers: with the help of their adult partner)

6. Bear, Webelos, Arrow of Light - Discover the types of targets that may be used and types that may not be used. (Note: not required for Lion, Tiger, or Wolf but the information may be presented)

### 7. Shooting Requirements:

<b>Lion</b>	Shoot 2 shots at a target. Repeat and do your best to improve your score. Shoot at least 4 shots.
<b>Tiger</b>	Shoot 3 shots at a target. Repeat and do your best to improve your score. Shoot at least 6 shots.
<b>Wolf</b>	Shoot 5 shots at a target. Repeat and do your best to improve your score. Shoot at least 10 shots.
<b>Bear</b>	Shoot 5 shots at a target. Repeat twice and do your best to improve your score each time. Shoot at least 15 shots.
<b>Webelos</b>	Shoot 5 shots at a target. Repeat twice and do your best to improve your score each time. Shoot at least 15 shots.
<b>Arrow of Light</b>	Shoot 5 shots at a target. Repeat three times and do your best to improve your score each time. Shoot at least 20 shots.

8. Discuss how to put away and properly store your slingshot and shooting equipment after use. (For Lion, Tiger, and Wolf, this is the 7th requirement; however, throughout this plan this requirement will be called Requirement 8.)

## SESSION I (45 MINUTES)

### PREPARATION & MATERIALS NEEDED

- Safety rules posters
- Appropriate safety equipment as specified in the *National Range and Target Manual*
- Appropriate slingshot equipment as specified in the *National Range and Target Manual*
- Approved targets

### TOPIC: GEAR & SAFETY

It is important that Cub Scouts learn the importance of safety rules while participating in range and target activities and the need for appropriate safety gear.

- Participants and range staff must wear eye protection (safety glasses) when the slingshot range is used.

To prepare the Cub Scouts for being on the shooting line, please do the following:

- Identify and demonstrate how to properly wear the safety equipment. (Requirement 1)
- Explain the range safety rules and range commands. It is important that the Rangemaster gets feedback

from the group to ensure complete understanding of the safety rules and range commands. Lions and Tigers will have assistance from their adult partner. Note: Webelos and Arrow Light have an added requirement to explain range commands to an adult or another Scout. (Requirements 2-3).

- Discuss the types of ammunition that may and may not be used. (Requirement 5)
- Discuss the types of targets that may and may not be used. This is not required for Lion, Tiger, or Wolf, but is useful information for them to have. (Requirement 6 for Bear, Webelos and Arrow of Light)

Move the group to the shooting line to do the following:

- Show and explain the main parts of the shooting equipment and how to safely use. (Requirement 4)
- Demonstrate proper stance and shooting techniques. Allow Cub Scouts to shoot for the remaining time in the session. (Requirement 7)

Requirements 1-6 (plus requirement 7 depending on the participant's den level and time allotted) should be complete after this session.

*Note: This session is important because it establishes the basis for range safety and understanding range commands, but it is equally important that the Cub Scouts get to shoot before leaving the session.*

## SESSION 2 [45 MINUTES]

### PREPARATION & MATERIALS NEEDED

- Safety rules posters
- Appropriate safety equipment as specified in the *National Range and Target Manual*
- Appropriate slingshot equipment as specified in the *National Range and Target Manual*
- Approved targets

### TOPIC: RANGE ACTIVITY

Review the range safety rules and range commands. To engage the Cub Scouts, ask them to explain the rules and range commands in their own words (rather than telling them).

- Cub Scouts shoot and attempt to complete requirement 7.
- Discuss how to put away and properly store your slingshot and shooting equipment after use. (Requirement 8)

Requirements 7-8 should be complete after this session.

## SESSION 3 [45 MINUTES]

### PREPARATION & MATERIALS NEEDED

- Safety rules posters
- Appropriate safety equipment as specified in the *National Range and Target Manual*
- Appropriate slingshot equipment as specified in the *National Range and Target Manual*
- Approved targets

### TOPIC: RANGE ACTIVITY

Review the range safety rules and range commands. To engage the Cub Scouts, ask them to explain the rules and range commands in their own words (rather than telling them).

- Cub Scouts continue to shoot. If requirement 7 was not completed during the previous session, those Cub Scouts may continue working on that requirement.
- If requirement 7 was completed during the previous session, Scouts should be encouraged to enjoy their time on the range by participating in an open shoot or may attempt a more difficult course of fire (i.e., reactive targets such as cow bells or spinning targets, smaller targets, more distant targets).

## SESSION 4 [45 MINUTES]

### PREPARATION & MATERIALS NEEDED

- Safety rules posters
- Appropriate safety equipment as specified in the *National Range and Target Manual*
- Appropriate slingshot equipment as specified in the *National Range and Target Manual*
- Approved targets

### TOPIC: RANGE ACTIVITY

Review the range safety rules and range commands. To engage the Cub Scouts, ask them to explain the rules and range commands in their own words (rather than telling them).

- Cub Scouts continue to shoot. If requirement 7 was not completed during the previous session, those Cub Scouts may continue working on that requirement.
- If requirement 7 was completed during the previous session, Scouts should be encouraged to enjoy their time on the range by participating in an open shoot or may attempt a more difficult course of fire (i.e., reactive targets such as cow bells or spinning targets, smaller targets, more distant targets).

## SESSION 5 (45 MINUTES)

### PREPARATION & MATERIALS NEEDED

- Safety rules posters
- Appropriate safety equipment as specified in the *National Range and Target Manual*
- Appropriate slingshot equipment as specified in the *National Range and Target Manual*
- Approved targets

### TOPIC: RANGE ACTIVITY

Review the range safety rules and range commands. To engage the Cub Scouts, ask them to explain the rules and range commands in their own words (rather than telling them).

- Cub Scouts continue to shoot. If requirement 7 was not completed during the previous session, those Cub Scouts may continue working on that requirement.
- If requirement 7 was completed during the previous session, Scouts should be encouraged to enjoy their time on the range by participating in an open shoot or may attempt a more difficult course of fire (i.e., reactive targets such as cow bells or spinning targets, smaller targets, more distant targets).

## RANGE REQUIREMENTS

### SLINGSHOT RANGE SET-UP

Slingshot program may utilize an approved BB gun or an approved archery range.

1. Select the orientation of the range
  - a. Avoid shooting into the sun by facing North
  - b. The ground should be flat and free of obstacles
  - c. Look for a natural backstop such as a berm to stop BB's, or a ballistic cloth or double layer, heavy duty tarp capable of stopping a bb as a trap. If there is no berm, provide a minimum of 195 yards of open area behind the targets.
  - d. The safety zone on the side should be 30-50 feet.
2. Place range and safety lines
  - a. Rope, eco-friendly spray paint or chalk are ways to lay down the range lines outdoors. Follow the guidelines illustrated in the *National Range and Target Manual*.
  - b. Shooting Line – The shooting line is 15 to 30 feet from the target line depending on the skill level of the participants.
  - c. Waiting Line – Shooters stand behind the waiting line before and after shooting their slingshot. It is meant to act as a safety area between the class and the shooting line. The waiting line is placed 15 feet behind the shooting line.

*OPTIONAL: Controlled Access/Spectator Line – Anyone who wants to watch participants shoot can gather behind this line. This line needs to be placed far enough behind the waiting line to prevent distraction from the spectators (at minimum 15 feet)*

3. Set-up targets
  - a. Place targets in front of the natural berm. If a natural berm is not available, place targets in a wide-open space with a minimum safety zone of 150 feet behind the targets.
  - b. Evenly space targets in front of the berm. Space between targets is dependent on placement of shooting positions.
  - c. One method of hanging targets is to put up posts to hold “snow fence.” Attach the snow fence to the posts. Targets can be attached to the snow fence with clothes pins.
  - d. A temporary target holder can be made using yard signs with wire ground stands.
4. Place the equipment
  - a. Eye protection should be available in the waiting area. All participants on the range must wear eye protection.
  - b. Slingshots – May be on the top of the bench if using the bench rest position, or on the mat used for the prone positions. If shooters are shooting from the standing position, there should be some type of stand where slingshots may be placed when not in use.
  - c. Ammunition – Should be stored in a secure location between the shooting line and the ready line under the supervision of the rangemaster.

# OUTDOOR RANGE LAYOUT: WIDE OPEN SPACE

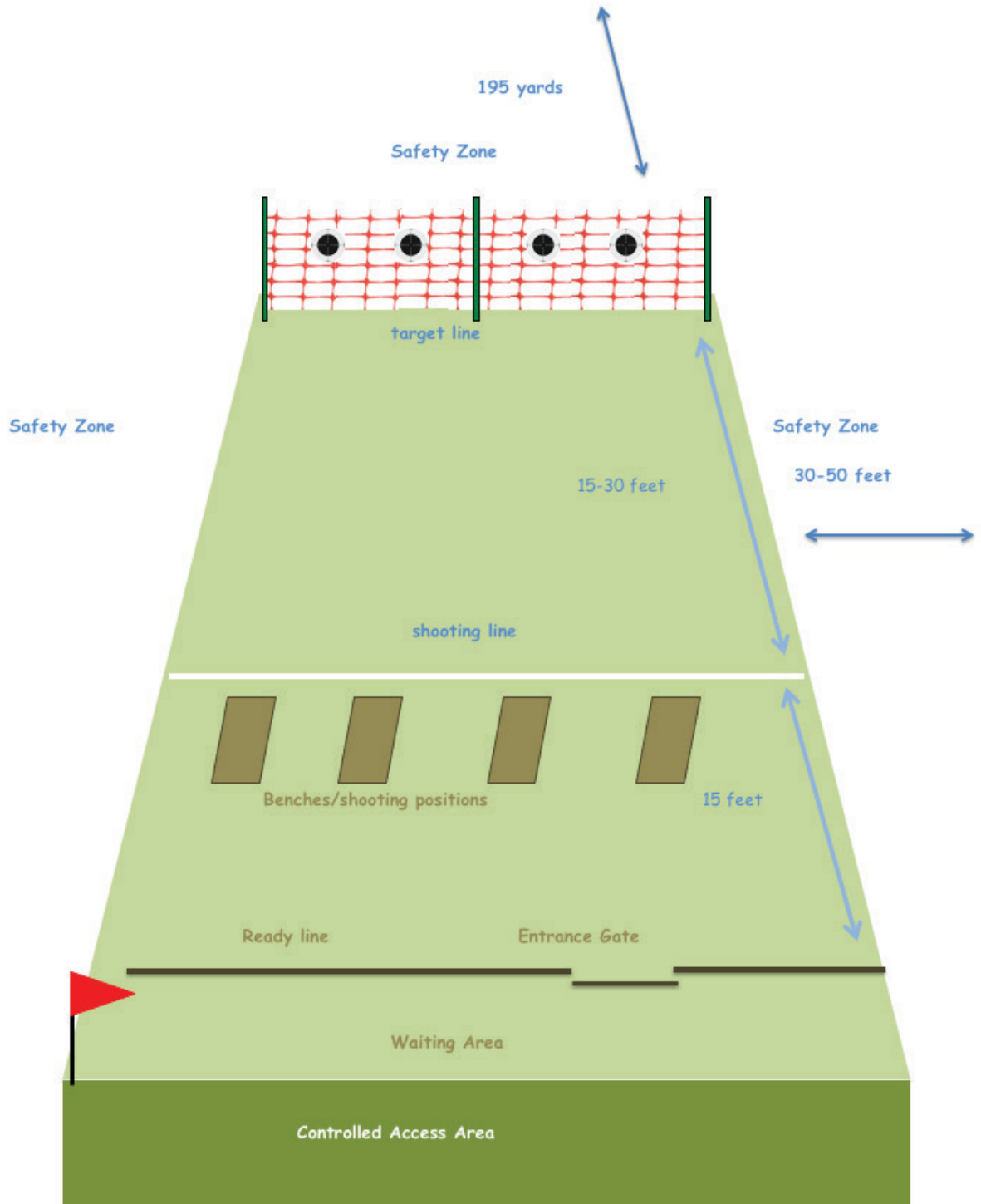

## SUGGESTIONS

Based on the format of your event, there might not be enough time in the program schedule to utilize 5 sessions to complete the Slingshot Adventure. You may also have dens with mixed ages and levels of knowledge and/or ability. There are times when a Cub Scout can attend only a few days of a day camp, so adjustments will need to be made.

Take the time to read the requirements, evaluate the number and the length of the sessions the event will have so you can determine what should be presented in the time allotted.

It is possible the adventure could be completed within 2 sessions or less depending on your event's program design:

- Length of each session
- Age of participants
- Experience level of the participants
- Number of participants in each den

## MIXED-AGED DENS

When dealing with dens of mixed ages, consider moving the more experienced participants (the older Scouts who have attended a range activity previously) to the shooting line after the safety briefing to begin their course of fire. The less experienced Scouts can then spend time learning range commands, how to use the safety equipment and how to use the slingshot equipment. This same method may be applied with larger groups. You may be required to recruit additional trained staff to maintain range supervision ratios.

## PARTIAL COMPLETION OF THE REQUIREMENTS

Depending on the type of event (i.e., one-day event) it is possible the adventure requirements may not be completed in their entirety. If this is the case, each participant should be given a list of the requirements completed so that they can bring it to the next council-sponsored event they attend.

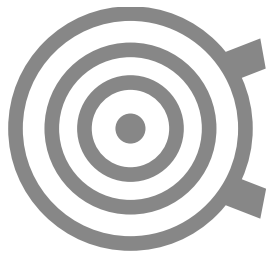

# GENERAL SHOOTING RANGE RULES

1. This range may be opened only by a qualified Scouting America-certified range master.
2. All commands issued by the range master must be obeyed immediately.
3. Stay behind the firing line. Do not straddle the firing line.
4. Do not pick up a gun, bow, arrow, or slingshot unless told to by the range master.
5. Absolutely no running on the range.
6. No horseplay or unnecessary talking on the range.
7. If in doubt about the rules, ask your leader or range master for advice or help.





# EYE DOMINANCE

Eye dominance is the unconscious preference to use one eye rather than the other to aim. The dominant eye often corresponds with the archer's dominant hand, but not always. There are a number of people who are "cross dominant," meaning they may be right-hand dominant and left-eye dominant, or vice versa.

It is important to understand how to determine eye dominance in the event a shooter or archer is struggling to aim or hit the target consistently. Eye dominance needs to be addressed when a shooter or archer is shooting with their dominant hand, but trying to aim with their opposite dominant eye. They may try to line up their dominant eye to the target by tipping their head over the bow or gun, causing their shots to be consistently left or right of center on the target.

---

## To Find the Dominant Eye

To find which eye is dominant, have participants extend both arms in front of them and form a small hole with their thumbs and index fingers. Instruct them to look at a distant object through the opening and then pull their hands back to their face. The eye that is in line with the object is dominant.









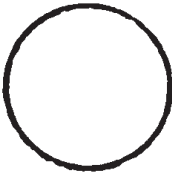

---

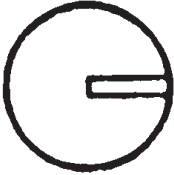
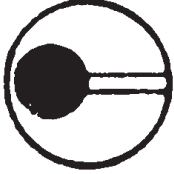
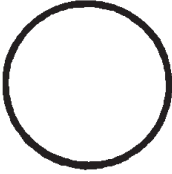
**Important Note: It is not necessary to make a Cub Scout who is cross dominant shoot with the non-dominant hand. The shooter may simply choose to continue shooting with the dominant hand and cover or close the non-dominant eye.**





# BB GUN SIGHTING CHART

	PEEP REAR SIGHT		POST FRONT SIGHT		PROPER ALIGNMENT		PROPER SIGHT PICTURE
	PEEP REAR SIGHT		APERTURE FRONT SIGHT		PROPER ALIGNMENT		PROPER SIGHT PICTURE
	OPEN REAR SIGHT		POST FRONT SIGHT		PROPER ALIGNMENT		PROPER SIGHT PICTURE



# PARTS OF A BB GUN

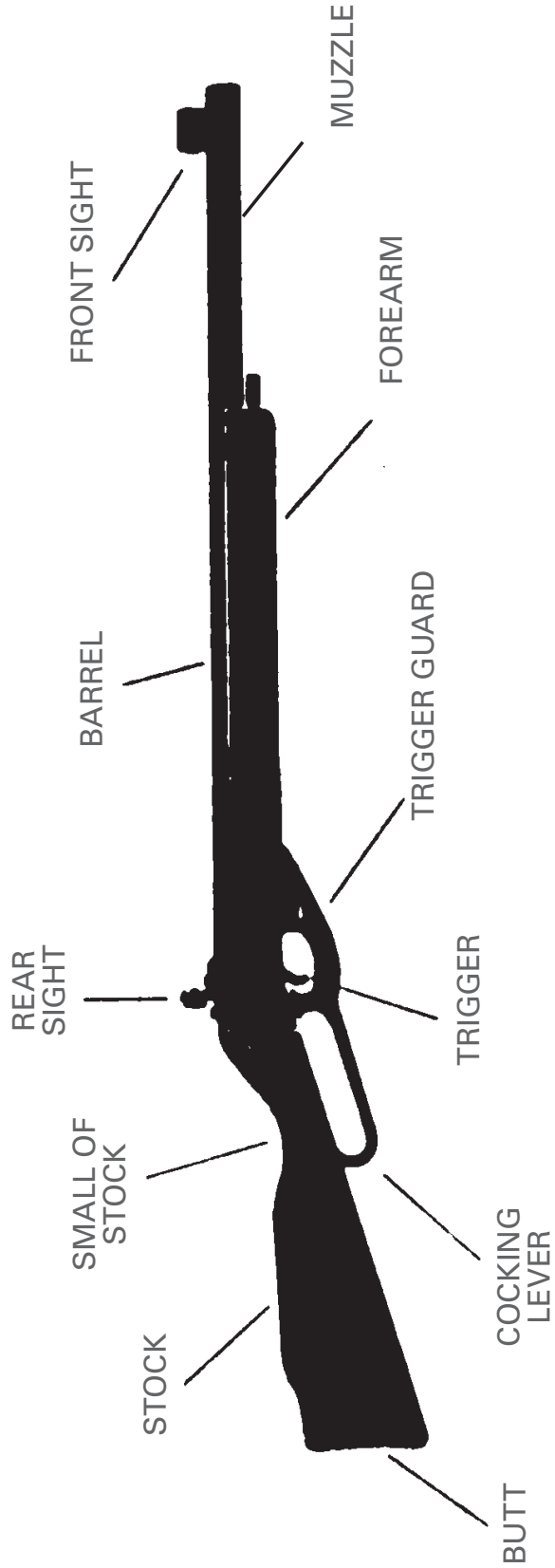



**IF YOU FIND A GUN**

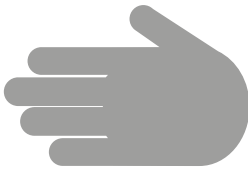

**STOP!**



**LEAVE THE AREA!**

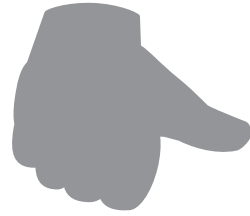

**DON'T TOUCH!**

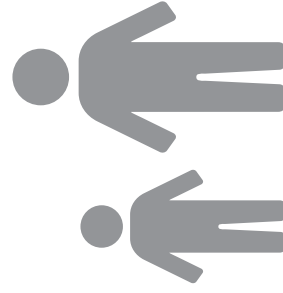

**TELL AN ADULT!**



# SUGGESTED BB GUN RANGE COMMANDS

**LOAD.**

**READY ON THE FIRING LINE.**

**COMMENCE FIRING.**

**CEASE FIRING.**

**CLEAR ALL GUNS.**

**LOAD YOUR BB GUN.**

**ALL SHOOTERS ARE READY.**

**YOU MAY FIRE YOUR BB GUN.**

**STOP SHOOTING.**

**SHOW YOUR BB GUN IS EMPTY. LAY IT DOWN.**



# SUGGESTED BB GUN SAFETY RULES

1. Always keep the gun pointed in a safe direction.
2. Always keep your finger off the trigger until you are ready to shoot.
3. Always keep the gun unloaded until ready to use.
4. Know how to use a gun safely.
5. Be sure the gun is safe to operate.
6. Use only the correct ammunition for the gun.





# BB GUN SHOOTING POSITIONS



PRONE POSITION



SITTING POSITION

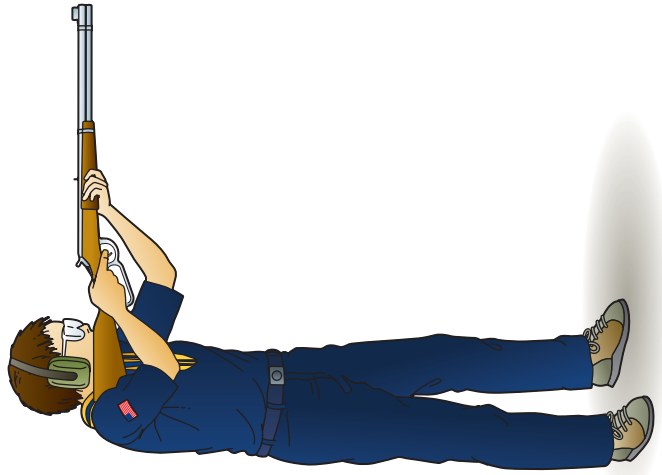

FREE-ARM STANDING POSITION

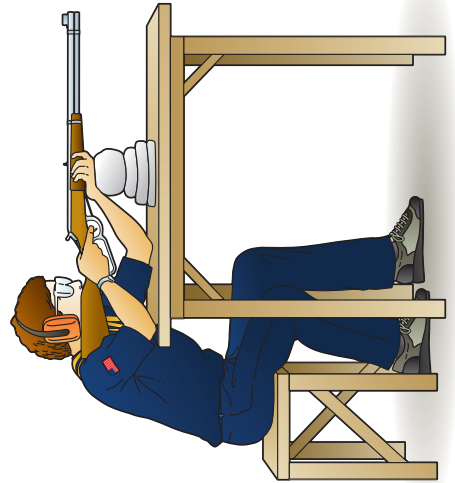

BENCHREST POSITION

# TIGER TARGET

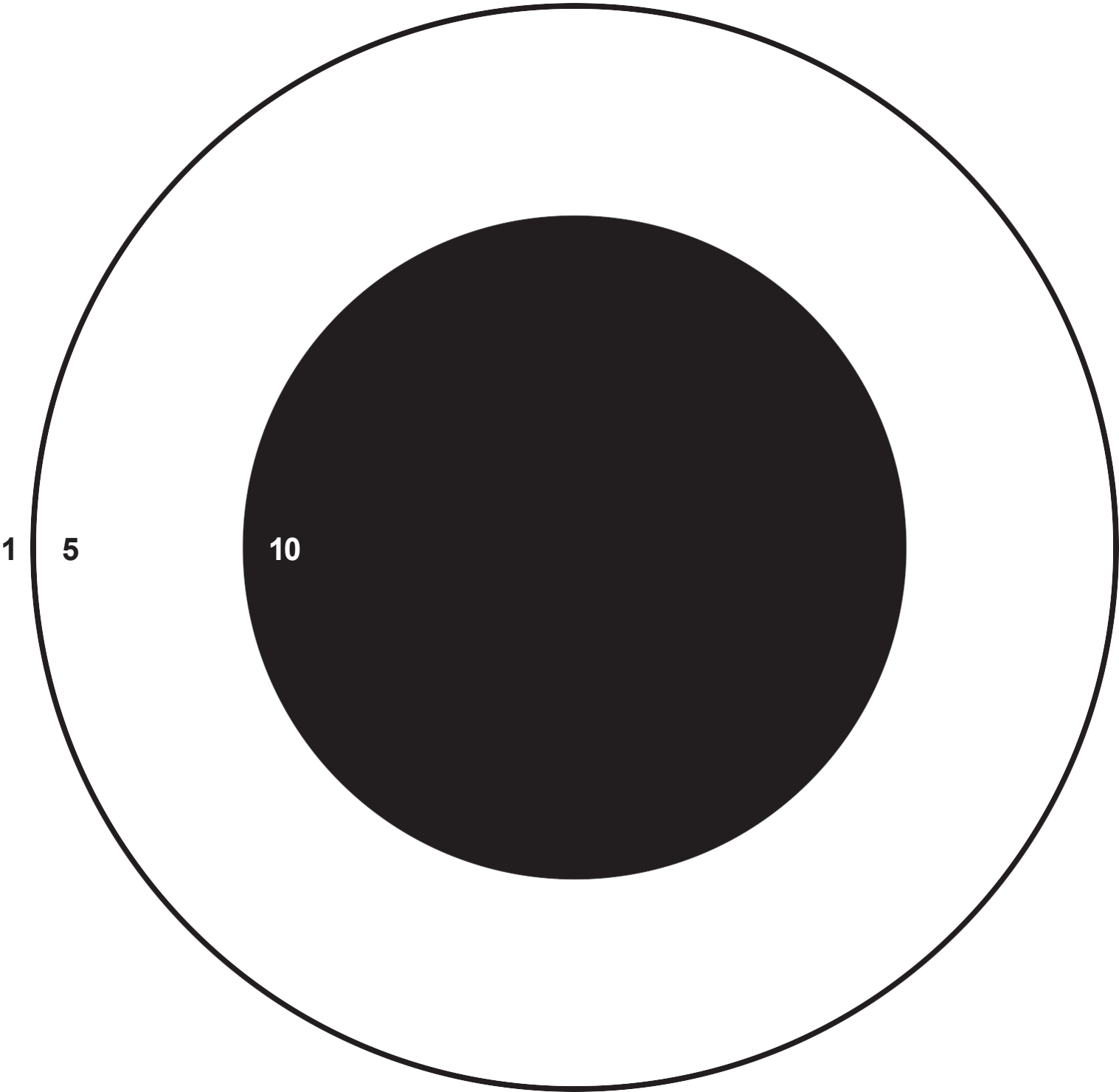

\_\_\_\_\_ Name

\_\_\_\_/\_\_\_\_/\_\_\_\_ Date

\_\_\_\_\_ Score

# WOLF/BEAR TARGET

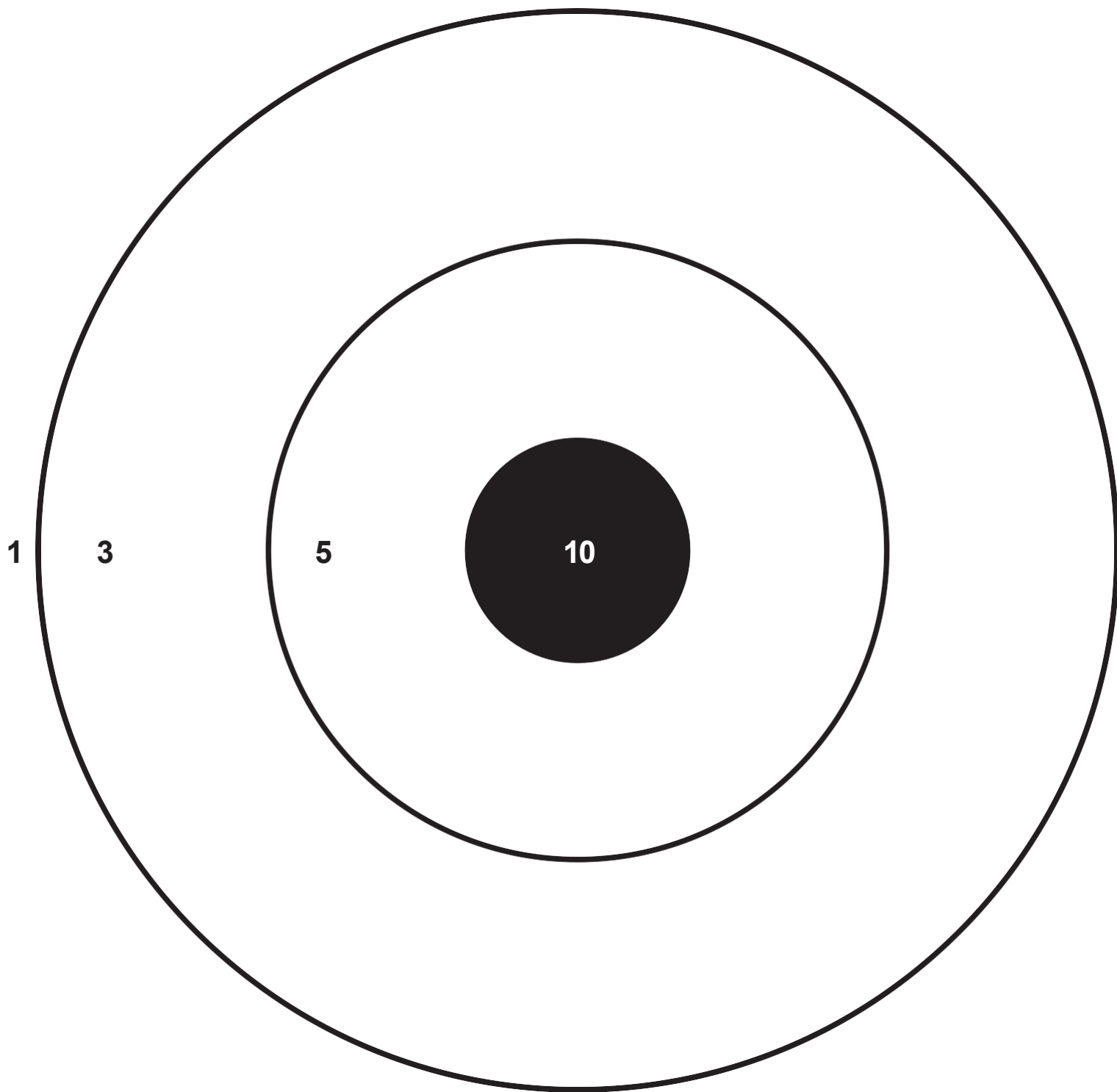

\_\_\_\_\_ Name

\_\_\_\_/\_\_\_\_/\_\_\_\_ Date

\_\_\_\_\_ Score

# WEBELOS/AOL TARGET

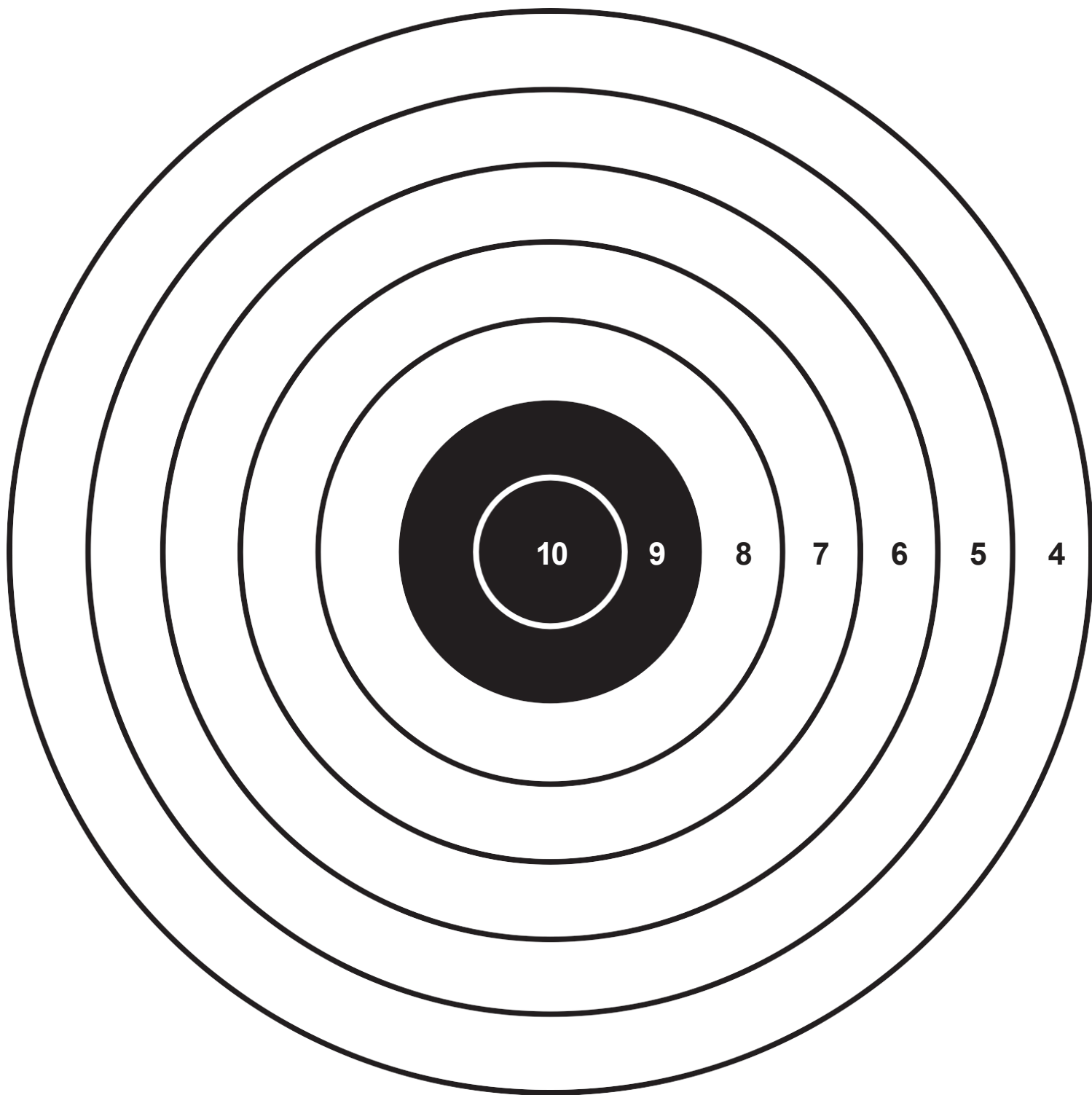

\_\_\_\_\_ Name

\_\_\_\_/\_\_\_\_/\_\_\_\_ Date

\_\_\_\_\_ Score

# ARCHERY RANGE RULES AND COMMANDS

## ARCHERY RANGE RULES

1. Always walk on the range.
2. Keep your arrows in your quiver until you are told to shoot.
3. Only release the bow string when an arrow is nocked and safely pointed toward the target.
4. Leave dropped arrows on the ground until instructed to retrieve them.

**If there is an emergency on the range, immediately tell the instructor.**

## KNOW THE PROPER WHISTLE CODES

**TWO BLASTS = Move up to the line.**

**ONE BLAST = Fire the proper number of arrows.**

**THREE BLASTS = Cease firing. Move to the target.**  
Retrieve and score arrows.

**FIVE OR MORE WHISTLE BLASTS = Cease firing. Stay**

**where you are. This is an EMERGENCY. Officials will tell the archers what action to take either verbally or by the whistle code.**

**Remember there is only ONE command to shoot — ONE blast of the whistle.**

**For any command of more than one blast, STOP shooting. Watch and listen for further instructions.**



# ARCHERY SHOOTING FORM

(Right-handed archer. Reverse instructions for left-handed archer.)

## Square Stance

- Turn sideways to the target, with left shoulder toward the target.
- Distribute weight evenly on both feet, which are shoulder-width apart.

## Nock the Arrow

- Lay the shaft of the arrow on the arrow rest, and nock the arrow by fitting the notched end of the arrow just below the string's nocking point.
- Face the odd-colored feather (cock) away from the bow.
- Grasp the arrow by the nock between the thumb and index finger of the right hand.

## Draw

- Bring the left hand up, turning the hand so the bow assumes a vertical position at arm's length.
- With the three fingers of the right hand serving as hooks, start the draw slowly.
- The index finger will be above the arrow and the middle two fingers below it.
- At full draw, the right elbow is back and in direct line with the tip of the arrow.

## Anchor

- At the completion of the draw, the relaxed thumb of the right hand finds an anchor spot under the jawbone.
- Using the jawbone as an anchor, the bowstring will touch the nose and the center of the chin.
- It is important that the anchor point be the same for every shot.

## Release or Loose

- The hand is opened with the fingers moving quickly and precisely off the nock and the string at the same time.
- Keep the left arm in the same position as for a full draw.
- Relax wrist.
- Keep alignment.
- Avoid tension.
- Keep the bow at the same level that it was at full draw.

## Follow-Through

- Keep aiming until the arrow hits the target.
- After release, the fingers should not be more than an inch away from and behind the anchor point.
- Hold the position until the arrow strikes the target to make certain the whole process is smooth.
- In a good follow-through, your right hand will be at the back of your neck and your arm will be lined up perfectly.

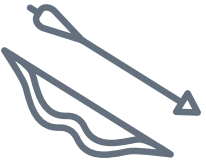

# TYPES OF ARCHERY BOWS

**RECURVE BOW**

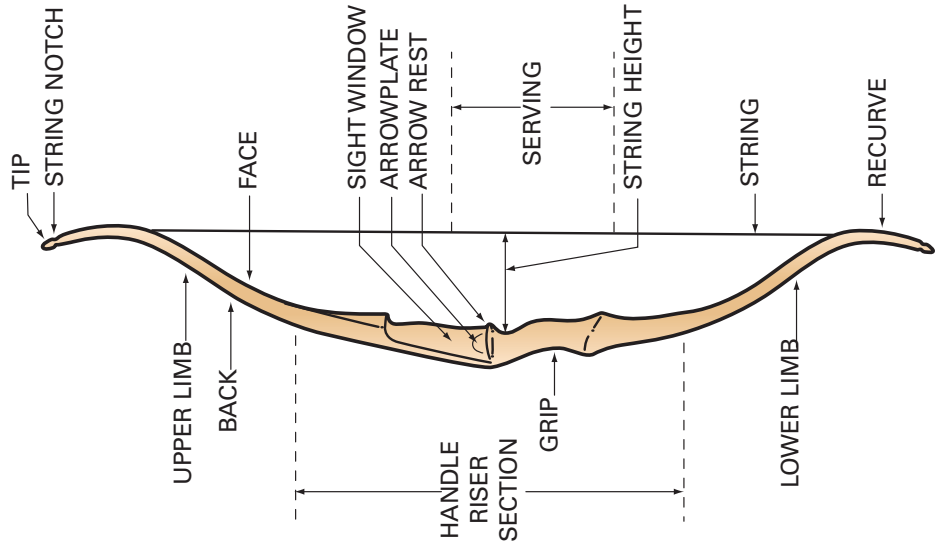

**COMPOUND BOW**

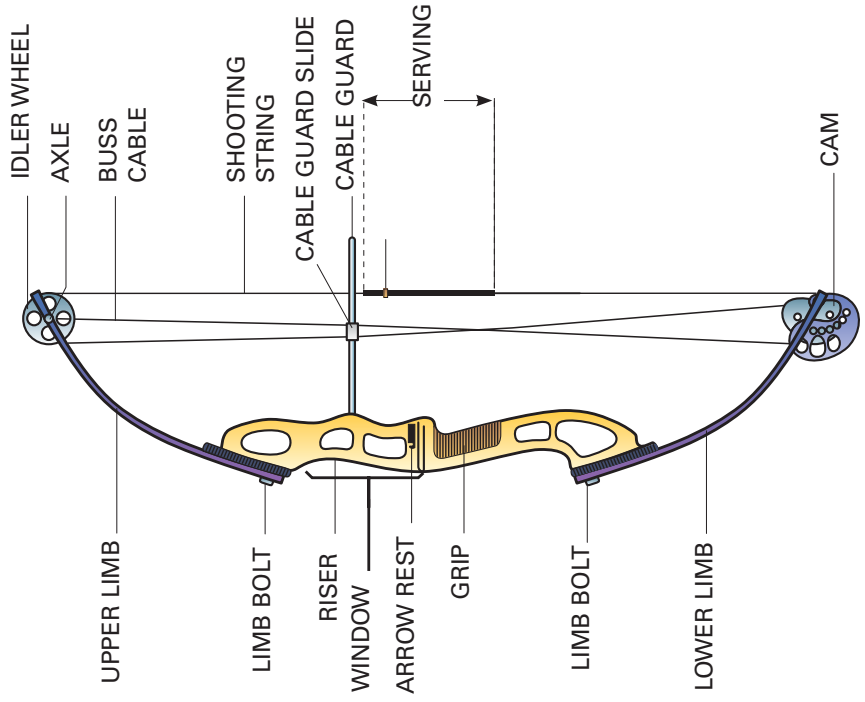





# GENERAL SLINGSHOT RANGE COMMANDS

**LOAD.**

**READY ON THE FIRING LINE.**

**COMMENCE FIRING.**

**CEASE FIRING.**

**LOAD YOUR SLINGSHOT.**

**ALL SHOOTERS ARE READY.**

**YOU MAY FIRE YOUR SLINGSHOT.**

**STOP SHOOTING.**



# GENERAL SLINGSHOT RANGE RULES

1. This range may be opened only by a certified Cub Scout shooting sports range master.
2. All commands issued by the range master must be obeyed immediately.
3. Stay behind the firing line. Do not straddle the firing line.
4. Do not pick up a slingshot unless told to by the range master.
5. Absolutely no running on the range.
6. No horseplay or unnecessary talking on the range.
7. If in doubt about the rules, ask your leader or range master for advice or help.



# SLINGSHOT SAFETY RULES

**ALWAYS KEEP THE SLINGSHOT POINTED IN A SAFE DIRECTION. YOUR RANGE MASTER WILL TELL YOU WHAT DIRECTION IS SAFE. IF YOU ARE NOT SURE, ASK.**

**ALWAYS KEEP THE BANDS AT REST UNTIL YOU ARE READY TO SHOOT.**

**ALWAYS KEEP THE POUCH AMMUNITION FREE UNTIL READY TO USE.**

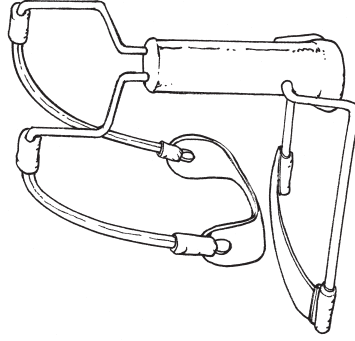



# PARTS OF A SLINGSHOT

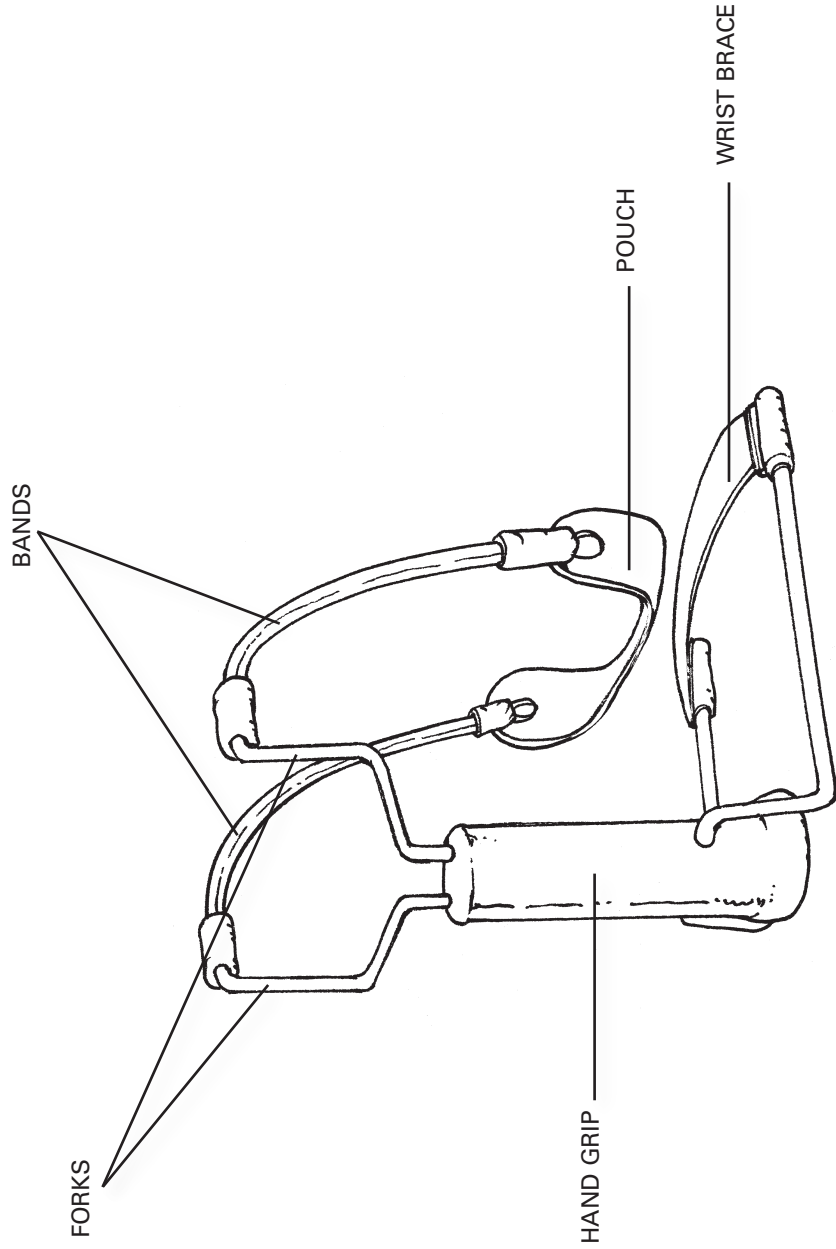

## APPENDIX 2: ADDITIONAL ACTIVITIES

### Range and Target Activities Program Ideas

Range and target activities in Cub Scouting are operated by local councils and districts. The suggestions here are designed for use at council- and district-sponsored events that provide range and target opportunities.

The activities described below can be used with slingshots, archery equipment, and BB guns. An important practice across all of Scouting is that we do not use targets that feature human beings or animals.

Targets for BBs, arrows, and slingshots can be made from a variety of materials, including paper, cans, plastic bottles, and balloons. Paper targets can be home-made or purchased. Cans are excellent as they make a great sound when hit. Cans, plastic bottles, and balloons can be hung from strings or attached to netting.

The distance between the shooter and the target can be varied depending on the shooter's level of experience. The distance can be increased as skills improve.

### Fun Target Activities for BB Shooting

#### Target Squares

Make 8.5-by-11-inch targets with several squares on each. Put a number in each square. Shooters can see the squares but not the numbers in them. After firing at the page, the shooter adds up the numbers from the squares that his or her BBs hit. The highest score is the winner.

#### Mystery Dots

Place dots on a target, then shoot at the back side of the target. Count the score from the dotted side.

#### BB Tic-Tac-Toe

Place three rows of three balloons on a target mat. Divide the group into two lines and have them stand in a single file 20 feet from the target. At the signal to shoot, each shooter will shoot one BB and step back. The second and each succeeding person will shoot one at a time. The first team to break three balloons in any line is the winning team.

#### Cracker Shoot

Set up crackers as targets. Have participants shoot at the narrow edges of the crackers.

#### Action BB Gun Shooting Course

Set up an action BB gun shooting course using several games or targets as different stations in the course. Each station could encourage the shooters to use a different shooting position. One station could be used to do maintenance work for the BB gun shooting program.

### Fun Target Ideas for Archery Shooting

#### Archery Tic-Tac-Toe

Place three rows of three balloons on a target mat. Divide the group into two lines and have them stand in a single file 20 feet from the target. At the signal to shoot, each archer will shoot one arrow and step back. The second and each succeeding person will shoot one at a time. The first team to break three balloons in any line is the winning team.

#### Wand Shooting

Place a strip of 1-inch masking tape over the target face from top to bottom. A point is scored when an arrow hits the tape anywhere on the target. Divide the group into two lines, and have them stand in a single file 20 feet from the target. At the signal to shoot, each archer will shoot one arrow and step back. The second and each succeeding person will shoot one at a time. The first team to get two points is the winning team.

#### Shoot the Monster

Participants shoot at a one-gallon plastic bottle, suspended with shock cord within a tire and painted to look like a monster. The object is to hit the plastic bottle. This event can be scored individually or by den or pack.

#### Ring the Bell

Participants shoot at bells through the open end of swinging tires. All tires are swung in unison with a rope tied to the bottom of each tire and extended to an area beyond the limits of firing on the side.

#### Football Placekick

A scaled-down goalpost is erected behind a 4-foot-high canvas sheet. From the firing line the archer can see only the top portion of the goalpost uprights. An arrow shot between the uprights above the crossbar scores as a field goal (three points), while an arrow that passes over the canvas and under the crossbar scores as a touchdown (six points). A raised platform should be set up adjacent to the shooting positions so an observer can determine the scoring, since the archer is not able to see the lower portion of the goalposts.

#### Archery Practice Fun

Any station set up for youth to practice skills is a fun station for the Cub Scouts. The program allows limited times to shoot arrows, so the opportunity to practice at a council camp or event is a great experience for them. A practice station is a simple, basic archery range, but a very fun one for the Scouts.

Archery stations could also be set up to practice stringing bows or to learn how to care for some of the equipment. Helping with some of the archery equipment could be a rainy day activity.

## Action Archery Course

An action archery course could be set up using several of these games as different stations in the course. A drawing of a sample action archery course is available in the *Scouting America Range and Target Activities Manual*.

## Fun Target Ideas for Slingshot Shooting

### Feed the Monster

Using a large piece of cardboard, sketch a monster. Cut a hole where the monster's mouth is located. Aim to feed the monster.

### Tin Can Alley

Hang tin cans from string. Place them at various heights and distances from the shooting line.

### Tire Target

Hang tires (or hoops) at different heights and distances from the shooting line.

### Ring-a-Ding

Hang bells from strings. Shoot to strike the bells.

### Chart Paper Target

Create a large target with chart paper. Draw circles of different sizes on the chart paper. Apply different scores to the circles, with large circles being worth fewer points.

### Slingshot Target Course

A target course could be set up using several of these games as different stations in the course. A drawing of a sample action archery course is available in the *Scouting America Range and Target Activities Manual* and can be adapted for a slingshot target course.

## Bikathlon

The bikathlon event is modeled after the winter Olympic biathlon in which competitors cross-country ski and shoot rifles. In the bikathlon, the Cub Scouts bike around an off-road course, stop at various points, dismount from the bikes to shoot targets that fall over when struck, and then continue along the course. Though the sport requires a certain amount of strength for the biking portion, the shooting sports activity is the key to the event.

### Setting Up the Course

Make the course approximately one-third of a mile in length, in the form of a loop so the starting line and a finishing line are in the same position. One point along the course becomes the firing line—with a separate position for each racer. Identify each firing point with a color, as assigned to each participant. Place a bike rack in a safe place with easy access. The course should not

be in a rocky area, and the instructors should walk it to ensure that all dangerous obstacles have been removed. The course can be an existing track or laid out with cones or rope guides to make sure each biker follows the same route.

### Running the Race

The bicycle is ridden to the shooting point, the youth dismounts, parks the bike, and shoots the targets. The biker shoots at each target until it is hit and knocked over, then remounts the bike and finishes the race. A limit may be imposed on the number of shots for each target and a time penalty imposed if the target is not knocked over.

The youth finishing the race in the shortest time is declared the winner. The key to the event is not only to pedal fast, but also to shoot quickly and accurately.

Shooting is normally done from the standing position but may be changed at the range director's discretion.

Participants are never allowed to ride the course with the gun, arrows, or slingshots. These items are to remain at the firing point at all times.

Every participant is required to attend a brief orientation on bike safety and handling the shooting sports materials used on the course before being allowed to participate in the bikathlon.

This safety session should, as a minimum, cover the following:

- Course layout and general rules
- Range procedure and safety
- How the match is scored
- How to operate and load the guns
- Shooting safety and safe gun handling
- Basics of sighting and shooting
- Bicycle use and riding safety
- Hands-on practice as time, personnel, equipment, and facilities allow

## Archery Range Rules and Commands

### EQUIPMENT AND MATERIALS

- Bikes
- Elbow and knee guards
- Safety helmets
- Stopwatch or other timing device
- BB approach:  
BB guns and BBs at each shooting station  
Safety glasses to be worn at the firing line
- Archery approach:  
Bow and quiver of arrows at each shooting station
- Slingshot approach:  
Slingshot and ammunition at each shooting station
- Alternative:  
Use all of the above at different stations.

### PERSONNEL

Assign adults to the following positions:

- Match director (responsible for the event)
- Jury (three people who are responsible for solving any dispute that may arise during the match and to ensure compliance of the rules by participants)
- Rangemasters (responsible for safety on the range)
- Statistical officer (responsible for tracking participants' total lapse time)
- Starter (the official who starts each relay or heat)
- Other personnel needed are timers, first-aid personnel, course marshals, and repair personnel (for guns, arrows, slingshots, and/or bikes)
- One staff member at each station

## Photo and Illustration Credits

All photos and illustrations are the property of or are protected by Scouting America.



## APPENDIX 19 - RESOURCES

### People

- Who to call for help
  - Contact your local council's range and target activities committee chair
  - Scouting America:  
[outdoorprograms@scouting.org](mailto:outdoorprograms@scouting.org)
- Local council websites
- The National Rifle Association
- Contact USA Archery, [www.usarchery.org](http://www.usarchery.org)
- Contacts at the National Shooting Sports Foundation

### Facilities

- Local council camps
- Local shooting sports clubs
  - National Wild Turkey Foundation, [www.nwtf.org](http://www.nwtf.org)
  - Issac Walton League, [www.iwla.org](http://www.iwla.org)
- Local ranges
  - State wildlife ranges. Contact your local department of natural resources.
  - Law enforcement ranges
  - National Forest Service ranges
- Local gun and archery businesses
  - May have local range information

### Materials/Literature

- National Rifle Association, [www.nra.org](http://www.nra.org)
- National Archery in the Schools Program, [www.naspschools.org](http://www.naspschools.org)
- National Sporting Clays Association, [www.mynsca.com](http://www.mynsca.com)
- National Skeet Shooters Association, [www.mynssa.com](http://www.mynssa.com)
- International Hunter Education Association, [www.ihea-usa.org](http://www.ihea-usa.org)
- National Muzzle Loading Rifle Association, [www.nmlra.org](http://www.nmlra.org)

### Equipment

- National Shooting Sports Foundation, [www.nssf.org](http://www.nssf.org)
- Archery Trade Association, [www.archerytrade.org](http://www.archerytrade.org)
- Daisy, [www.daisy.com](http://www.daisy.com)
- Crosman, [www.crosman.com](http://www.crosman.com)
- Benelli, [www.benelliusa.com](http://www.benelliusa.com)
- Beretta USA, [www.berettausa.com](http://www.berettausa.com)
- Browning, [www.browning.com](http://www.browning.com)
- Remington, [www.remington.com](http://www.remington.com)
- Winchester, [www.winchester.com](http://www.winchester.com)
- Federal Premium Ammunition, [www.federalpremium.com](http://www.federalpremium.com)

### Programs

#### *Advancement and recognitions*

- Scouts BSA
  - Merit badges. Refer to Chapter 3, “Merit Badge Counselors,” rifle shooting, shotgun shooting, archery.
- Cub Scout
  - Cub Scout Range and Target Activities adventures (BB, Archery, Slingshot)
- Venturing
  - Ranger Award
  - Venturing Range Activities Outstanding Achievement Award.

# Prepared. For Life.®



Scouting America  
1325 W. Walnut Hill Ln  
P.O. Box 152079  
Irving, TX 75015-2079  
[www.scouting.org](http://www.scouting.org)

430-938  
ISBN 978-0-8395-0004-9  
©2022 Boy Scouts of America  
2025 Printing